

DX100 OPTIONS INSTRUCTIONS

SUPPLEMENTARY FOR CONVEYOR SYNCHRONIZED FUNCTION
CONTINUOUS OPERATION CONVEYOR SYNCHRONIZED FUNCTION

Upon receipt of the product and prior to initial operation, read these instructions thoroughly, and retain for future reference.

MOTOMAN INSTRUCTIONS

MOTOMAN-□□□ INSTRUCTIONS
DX100 INSTRUCTIONS
DX100 OPERATOR'S MANUAL
DX100 MAINTENANCE MANUAL

The DX100 operator's manual above corresponds to specific usage.
Be sure to use the appropriate manual.

Part Number: 156791-1CD
Revision: 1



MANUAL NO.

HW0485573



MANDATORY

- This manual explains the conveyor synchronized function of the DX100 system. Read this manual carefully and be sure to understand its contents before handling the DX100.
- General items related to safety are listed in Section 1: Safety of the DX100 Instructions. To ensure correct and safe operation, carefully read the DX100 Instructions before reading this manual.



CAUTION

- Some drawings in this manual are shown with the protective covers or shields removed for clarity. Be sure all covers and shields are replaced before operating this product.
- The drawings and photos in this manual are representative examples and differences may exist between them and the delivered product.
- YASKAWA may modify this model without notice when necessary due to product improvements, modifications, or changes in specifications.
- If such modification is made, the manual number will also be revised.
- If your copy of the manual is damaged or lost, contact a YASKAWA representative to order a new copy. The representatives are listed on the back cover. Be sure to tell the representative the manual number listed on the front cover.
- YASKAWA is not responsible for incidents arising from unauthorized modification of its products. Unauthorized modification voids your product's warranty.



Everything for your HMI running

✉ sales@vicpas.com

☎ +86-15876525394

DX100

Notes for Safe Operation

Read this manual carefully before installation, operation, maintenance, or inspection of the DX100.

In this manual, the Notes for Safe Operation are classified as "WARNING", "CAUTION", "MANDATORY", or "PROHIBITED".



WARNING

Indicates a potentially hazardous situation which, if not avoided, could result in death or serious injury to personnel.



CAUTION

Indicates a potentially hazardous situation which, if not avoided, could result in minor or moderate injury to personnel and damage to equipment. It may also be used to alert against unsafe practices.



MANDATORY

Always be sure to follow explicitly the items listed under this heading.



PROHIBITED

Must never be performed.

Even items described as "CAUTION" may result in a serious accident in some situations.

At any rate, be sure to follow these important items



To ensure safe and efficient operation at all times, be sure to follow all instructions, even if not designated as "CAUTION" and "WARNING".



WARNING

- Before operating the manipulator, check that servo power is turned OFF pressing the emergency stop buttons on the front door of the DX100 and the programming pendant.
When the servo power is turned OFF, the SERVO ON LED on the programming pendant is turned OFF.

Injury or damage to machinery may result if the emergency stop circuit cannot stop the manipulator during an emergency. The manipulator should not be used if the emergency stop buttons do not function.

Fig. : Emergency Stop Button



- Once the emergency stop button is released, clear the cell of all items which could interfere with the operation of the manipulator.
Then turn the servo power ON.

Injury may result from unintentional or unexpected manipulator motion.

Fig. : Release of Emergency Stop



- Observe the following precautions when performing teaching operations within the P-point maximum envelope of the manipulator:
 - View the manipulator from the front whenever possible.
 - Always follow the predetermined operating procedure.
 - Keep in mind the emergency response measures against the manipulator's unexpected motion toward you.
 - Ensure that you have a safe place to retreat in case of emergency.

Improper or unintended manipulator operation may result in injury.

- Confirm that no person is present in the P-point maximum envelope of the manipulator and that you are in a safe location before:
 - Turning ON the power for the DX100.
 - Moving the manipulator with the programming pendant.
 - Running the system in the check mode.
 - Performing automatic operations.

Injury may result if anyone enters the P-point maximum envelope of the manipulator during operation. Always press an emergency stop button immediately if there is a problem.

The emergency stop buttons are located on the right of front door of the DX100 and the programming pendant.

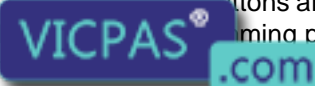

Everything for your HMI running

✉ sales@vicpas.com

☎ +86-15876525394

DX100



CAUTION

- Perform the following inspection procedures prior to conducting manipulator teaching. If problems are found, repair them immediately, and be sure that all other necessary processing has been performed.
 - Check for problems in manipulator movement.
 - Check for damage to insulation and sheathing of external wires.
- Always return the programming pendant to the hook on the cabinet of the DX100 after use.

The programming pendant can be damaged if it is left in the manipulator's work area, on the floor, or near fixtures.

- Read and understand the Explanation of Warning Labels in the DX100 Instructions before operating the manipulator:

Definition of Terms Used Often in This Manual

The MOTOMAN is the YASKAWA industrial robot product.

The MOTOMAN usually consists of the manipulator, the controller, the programming pendant, and supply cables.

In this manual, the equipment is designated as follows:

Equipment	Manual Designation
DX100 controller	DX100
DX100 programming pendant	Programming pendant
Cable between the manipulator and the controller	Manipulator cable

DX100

Descriptions of the programming pendant, buttons, and displays are shown as follows:

Equipment		Manual Designation
Programming Pendant	Character Keys	The keys which have characters printed on them are denoted with []. ex. [ENTER]
	Symbol Keys	The keys which have a symbol printed on them are not denoted with [] but depicted with a small picture. ex. page key  The cursor key is an exception, and a picture is not shown.
	Axis Keys Number Keys	"Axis Keys" and "Number Keys" are generic names for the keys for axis operation and number input.
	Keys pressed simultaneously	When two keys are to be pressed simultaneously, the keys are shown with a "+" sign between them, ex. [SHIFT]+[COORD]
	Displays	The menu displayed in the programming pendant is denoted with { }. ex. {JOB}

Description of the Operation Procedure

In the explanation of the operation procedure, the expression "Select ●●●" means that the cursor is moved to the object item and the SELECT key is pressed, or that the item is directly selected by touching the screen.

1	Continuous operation conveyor synchronized function.....	1-1
2	Instructions related to continuous operation conveyor synchronization.....	2-1
2.1	SYSTART instruction.....	2-1
2.1.1	Syntax tree	2-1
2.1.2	Addition of [CONT] tag.....	2-1
2.1.3	Addition of [TRAP] tag	2-1
2.2	SYEND instruction	2-2
2.2.1	Syntax tree	2-2
2.2.2	Addition of [CONT] tag.....	2-2
2.3	GETS instruction.....	2-3
3	Application example.....	3-1
3.1	System configuration	3-1
3.2	Overall processing flow.....	3-1
3.3	Example of a job	3-2
3.4	Notes	3-3

1 Continuous operation conveyor synchronized function

The “conveyor synchronized function” has been used in such applications as painting and sealing of large work pieces that are brought in mainly on a single conveyor.

On the other hand, for applications in which work pieces that are brought in intermittently on a conveyor are handled, and subsequently paid out on a different conveyor (while synchronized with the motion of the conveyor), it is necessary to frequently switch over between synchronization control of the carry-in side conveyor, and synchronization control of the discharge side conveyor.

In order to switch over conveyor synchronization control using the conventional conveyor synchronized function, it is necessary to end the conveyor synchronized status after the conveyor synchronization operation has been fully completed. This will enable the next conveyor synchronization operation to be executed. For this reason, each time synchronization control is switched over, the robot always stops momentarily.

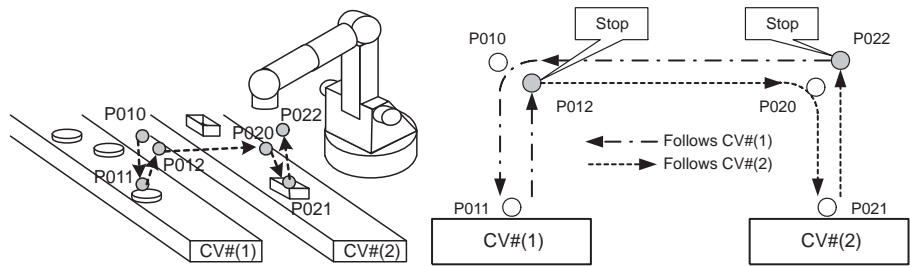

The “continuous operation conveyor synchronized function” is an expanded version of the conveyor synchronized function. It enables the interpolation motion to continue during conveyor synchronization switchover between two different conveyors.

By using this method of control, conveyor synchronization can be realized without stopping the synchronization switchover operation, hence the cycle time can be reduced.

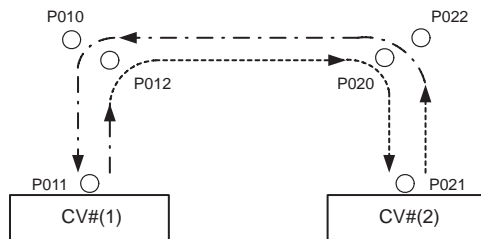

2 Instructions related to continuous operation conveyor synchronization

DX100 2.1 SYSTART instruction

2 Instructions related to continuous operation conveyor synchronization

The continuous operation conveyor synchronized function is an expanded version of the conventional “conveyor synchronous operation function.” Consequently, the basic part of this function is identical to the conventional conveyor synchronous operation function.

For details, refer to the “DX100 Conveyor Synchronous Operation Function Instruction Manual.”

Here, a description is given of the part concerning “continuous operation conveyor synchronization.”

2.1 SYSTART instruction

The SYSTART instruction is a instruction which indicates the start of the conveyor synchronous operation section.

2.1.1 Syntax tree

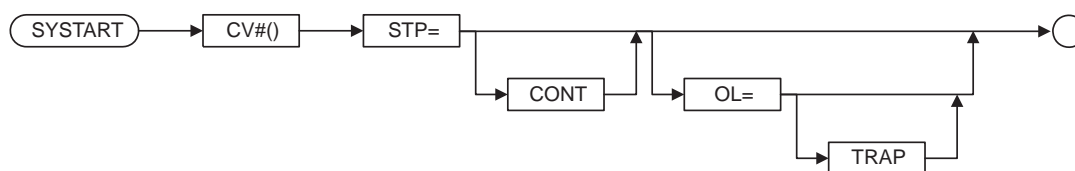

2.1.2 Addition of [CONT] tag

In order to execute continuous operation conveyor synchronization, the CONT tag must be added to the SYSTART instruction.

By adding the CONT tag, switchover from the specified conveyor synchronization section to the next conveyor synchronization section can be performed without interruption.

2.1.3 Addition of [TRAP] tag

During execution of the SYSTART instruction, if the conveyor position has already gone past STP, and in addition the allowable quantity (the maximum excess amount specified by “OL=”) has been exceeded, the SYSTART instruction will be terminated, and conveyor synchronization will not be executed.

Consequently, normally after the SYSTART instruction has been executed, the \$B variable (\$B008) is read using the GETS instruction, and a check is carried out “to see if conveyor synchronization started normally.” If conveyor synchronization was not executed, the job execution destination is changed using a JUMP instruction.

```

:
SYSTART CV#(1) STP=50.000 OL=10.0
GETS B000 $B008
JUMP *END IF B000=0
SYMOVL CV#(1) CTP=60.000
SYMOVL CV#(1) CTP=70.000
*END
SYENI
:

```

2 Instructions related to continuous operation conveyor synchronization
 DX100 2.2 SYEND instruction

However, in the case of such a job configuration, it is not known whether or not a JUMP instruction will be executed until the actual time of execution, so a prior read operation (an operation for reducing the instruction processing time by performing the necessary computation for execution of the instruction in advance) cannot be executed.

Consequently, operation cannot take place continuously when a SYSTART instruction is executed.

For this reason, a "TRAP" tag is added to the SYSTART instruction. When a TRAP tag is used, a prior read operation takes place based on the assumption that "conveyor synchronization is executed normally."

When a TRAP tag is used, if conveyor synchronization was not executed because the allowable quantity was exceeded, the program will jump to the label position specified by the TRAP tag.

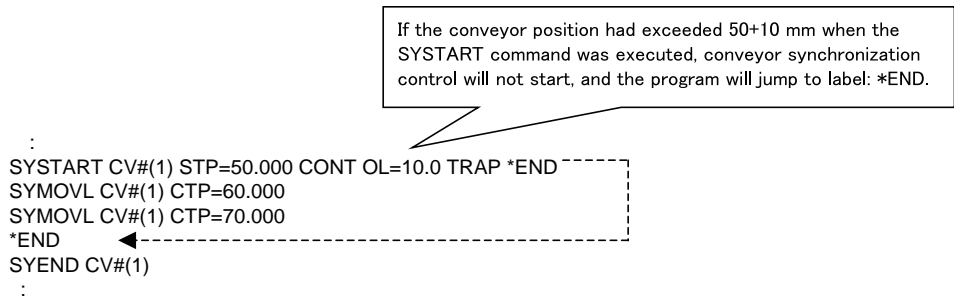

2.2 SYEND instruction

The SYEND instruction is an instruction which indicates the end of the conveyor synchronous operation section.

2.2.1 Syntax tree

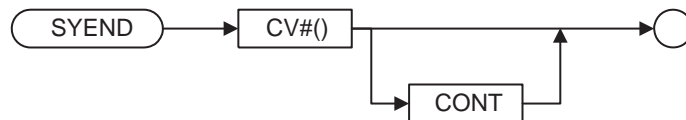

2.2.2 Addition of [CONT] tag

Normally, when a SYEND instruction is executed, the conveyor origin registration status is canceled, and when the conveyor origin limit switch is subsequently turned ON, the conveyor origin is updated.

However, if the conveyor synchronization is switched over frequently, and the conveyor waits for an input from the limit switch during each switchover, the processing time will become long. To overcome this, the program will be modified so that each time a conveyor SYSTART instruction is executed, the conveyor position is not reset but remains fixed, and conveyor synchronization control alone starts and ends.

When a [CONT] tag is added to the SYEND instruction, the conveyor follow-up operation ends, but the conveyor origin registration status is not canceled, permitting ongoing monitoring of the conveyor position.

Consequently, there is no need to input the conveyor origin limit each time the conveyor synchronization is to be switched over.



2 Instructions related to continuous operation conveyor synchronization

2.3 GETS instruction

2.3 GETS instruction

In order to make an STP specification using a SYSTART instruction, or set the value of a CTP specification of an SYMOVL instruction to a value that corresponds to the position of the work piece or the tray with respect to the conveyor, it is necessary to acquire the conveyor position as the "instant at which the work piece is detected using a vision camera" or the "instant at which the tray is detected by the sensor," for example. When a GETS instruction is used, the present position of the conveyor can be acquired as a double accuracy type variable (D variable).

\$D004 : Present position of conveyor CV# (1)

\$D005 : Present position of conveyor CV# (2)

\$D006 : Present position of conveyor CV# (3)

\$D007 : Present position of conveyor CV# (4)

\$D008 : Present position of conveyor CV# (5)

\$D009 : Present position of conveyor CV# (6)

* Unit : 0.001 mm

● Method of use

GETS D0010 \$D004 ... The present position of the CV#(1) conveyor is stored in D0010.

	3	Application example
DX100	3.1	System configuration

3 Application example

The continuous operation conveyor synchronized function is used in a system that necessitates frequent switchover of synchronization control for a different conveyor.

Concretely, this function can be used with the following picking system, for example.

3.1 System configuration

- The work pieces are supplied randomly from the “carry-in side conveyor.” The position of the work piece can be detected by a vision camera. The information concerning the detected position is sent to the robot controller.
- There are trays on the “discharge side conveyor” for holding the work pieces. The end face of the tray can be detected by a photoelectric tube sensor.
- An encoder is installed on each conveyor, and the information output from the encoder is sent to the robot controller.

3.2 Overall processing flow

[Detecting the position of the work piece]

- The work pieces that are brought in on the carry-in side conveyor are detected by a vision camera, and the position information is stored as a variable. The conveyor position at the time of detection is also stored. This operation is repeated at the prescribed timing.

[Detection of tray position]

- The trays that are brought in on the discharge side conveyor are recognized by a sensor, and the conveyor position when a signal is received from the sensor is stored as a variable.

[Removing and storing the work pieces]

- When a work piece arrives at the front of the robot, it is removed while the conveyor is being synchronized with the robot.
- The removed work piece is stored in a tray on the discharge side conveyor while the conveyor is being synchronized with the robot.

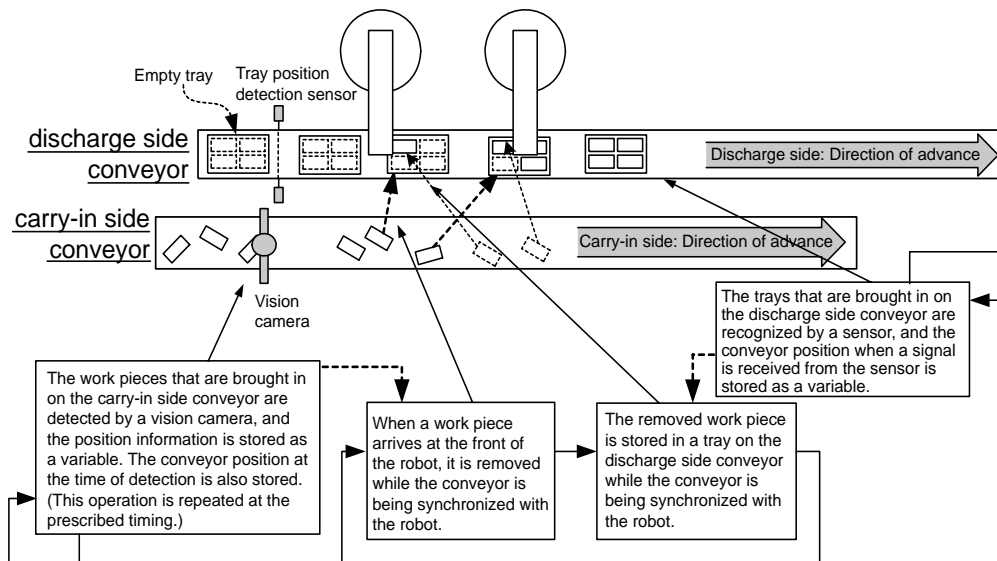

3.3 Example of a job

Shown below is an example of a motion job in which the conveyor synchronization instruction (SYMOVL) for removing and storing the work piece is actually executed.

```

NOP
:
*0
' === Pick ===
CALL JOB:PickPos-Calc
SYSTART CV#(1) STP=D021 CONT OL=D023 TRAP *PASS1
SYMOVL P0010 V=5000.0 CV#(1) CTP=D025
SYMOVL P0011 V=5000.0 CV#(1) CTP=D025
DOUT OT#(10) ON // Vacuum
TIMER T=0.02
SYMOVL P0012 V=5000.0 CV#(1) CTP=D025
*PASS1
SYEND CV#(1) CONT
:
' === Place ===
CALL JOB:PlacePos-Calc
SYSTART CV#(2) STP=D031 CONT OL=D033 TRAP *PASS2
SYMOVL P0020 V=5000.0 CV#(2) CTP=D035
SYMOVL P0021 V=5000.0 CV#(2) CTP=D035
DOUT OT#(10) OFF // Vacuum
TIMER T=0.02
SYMOVL P0022 V=5000.0 CV#(2) CTP=D035
*PASS2
SYEND CV#(2) CONT
JUMP *0
:
END

```

	3	Application example
DX100	3.4	Notes

Note that the overall flow of [detection of the work piece position], [detection of the tray position], and so on, can be realized by performing parallel execution using an independent control function (optional).

3.4 Notes

- If a “instruction that cannot execute continuous operation,” such as a TIMER instruction, exists between the end of conveyor synchronization (SYEND) and the start of the next conveyor synchronization (SYSTART), continuous operation will not take place.

DX100 OPTIONS INSTRUCTIONS

SUPPLEMENTARY FOR CONVEYOR SYNCHRONIZED FUNCTION CONTINUOUS OPERATION CONVEYOR SYNCHRONIZED FUNCTION

HEAD OFFICE

2-1 Kurosaki-Shiroishi, Yahatanishi-ku, Kitakyusyu-shi, 806-0004, Japan
Phone +81-93-645-7745 Fax +81-93-645-7746

MOTOMAN INC. HEADQUARTERS

805 Liberty Lane, West Carrollton, OH 45449, U.S.A.
Phone +1-937-847-6200 Fax +1-937-847-6277

MOTOMAN ROBOTICS EUROPE AB

Franska Vagen 10, Box 4004, SE-390 04 Kalmar, Sweden
Phone +46-480-417800 Fax +46-480-417999

MOTOMAN ROBOTEC GmbH

Kammerfeld strasse 1, 85391 Allershausen, Germany
Phone +49-8166-90-100 Fax +49-8166-90-103

YASKAWA ELECTRIC KOREA CORPORATION

1F, Samyang Bldg. 89-1, Shinchun-dong, Donk-Ku, Daegu, Korea
Phone +82-53-382-7844 Fax +82-53-382-7845

YASKAWA ELECTRIC (SINGAPORE) PTE. LTD.

151 Lorong Chuan, #04-01, New Tech Park, Singapore 556741
Phone +65-6282-3003 Fax +65-6289-3003

YASKAWA ELECTRIC (MALAYSIA) SDN. BHD.

Unit 47-1 and 2, Jalan PJU 5/9, Dataran Sunway, Kota Damansara, 47810, Petaling Jaya Selangor, Malaysia
Phone +60-3614-08919 Fax +60-3614-08929

YASKAWA ELECTRIC (THAILAND) CO., LTD.

252/246, 4th Floor, Muang Thai-Phatra office Tower II Rechedapisek Road, Huaykwang Bangkok 10320, Thailand
Phone +66-2-693-2200 Fax +66-2-693-4200

SHOUGANG MOTOMAN ROBOT CO., LTD.

No.7, Yongchang-North Road, Beijing Economic and Technological and Development Area, Beijing 100076, China
Phone +86-10-6788-0541 Fax +86-10-6788-0542

MOTOMAN MOTHERSON ROBOTICS LTD.

Plot Number 195-196, First Floor, Imt Manesar -Sector 4, Gurgaon (Haryana), Pin-122050, India
Phone +91-124-475-8500 Fax +91-124-475-8542



YASKAWA ELECTRIC CORPORATION

YASKAWA

Specifications are subject to change without notice
for ongoing product modifications and improvements.



© Printed in Japan June 2009 09-06

MANUAL NO.

HW0485573

15/15

DX100 OPTIONS INSTRUCTIONS

FOR CONVEYOR SYNCHRONIZED FUNCTION

Upon receipt of the product and prior to initial operation, read these instructions thoroughly, and retain for future reference.

MOTOMAN INSTRUCTIONS

MOTOMAN-□□□ INSTRUCTIONS
DX100 INSTRUCTIONS
DX100 OPERATOR'S MANUAL
DX100 MAINTENANCE MANUAL

The DX100 operator's manual above corresponds to specific usage.
Be sure to use the appropriate manual.



MANUAL NO.

HW0485517



MANDATORY

- This manual explains the conveyor synchronized function of the DX100 system. Read this manual carefully and be sure to understand its contents before handling the DX100.
- General items related to safety are listed in Chapter 1: Safety of the DX100 Instructions. To ensure correct and safe operation, carefully read the DX100 Instructions before reading this manual.



CAUTION

- Some drawings in this manual are shown with the protective covers or shields removed for clarity. Be sure all covers and shields are replaced before operating this product.
- The drawings and photos in this manual are representative examples and differences may exist between them and the delivered product.
- YASKAWA may modify this model without notice when necessary due to product improvements, modifications, or changes in specifications.
- If such modification is made, the manual number will also be revised.
- If your copy of the manual is damaged or lost, contact a YASKAWA representative to order a new copy. The representatives are listed on the back cover. Be sure to tell the representative the manual number listed on the front cover.
- YASKAWA is not responsible for incidents arising from unauthorized modification of its products. Unauthorized modification voids your product's warranty.



Everything for your HMI running

✉ sales@vicpas.com

☎ +86-15876525394

DX100

Notes for Safe Operation

Read this manual carefully before installation, operation, maintenance, or inspection of the DX100.

In this manual, the Notes for Safe Operation are classified as "WARNING", "CAUTION", "MANDATORY", or "PROHIBITED".



WARNING

Indicates a potentially hazardous situation which, if not avoided, could result in death or serious injury to personnel.



CAUTION

Indicates a potentially hazardous situation which, if not avoided, could result in minor or moderate injury to personnel and damage to equipment. It may also be used to alert against unsafe practices.



MANDATORY

Always be sure to follow explicitly the items listed under this heading.



PROHIBITED

Must never be performed.

Even items described as "CAUTION" may result in a serious accident in some situations.

At any rate, be sure to follow these important items



To ensure safe and efficient operation at all times, be sure to follow all instructions, even if not designated as "CAUTION" and "WARNING".



WARNING

- Before operating the manipulator, check that servo power is turned OFF pressing the emergency stop buttons on the front door of the DX100 and the programming pendant.
When the servo power is turned OFF, the SERVO ON LED on the programming pendant is turned OFF.

Injury or damage to machinery may result if the emergency stop circuit cannot stop the manipulator during an emergency. The manipulator should not be used if the emergency stop buttons do not function.

Fig. : Emergency Stop Button



- Once the emergency stop button is released, clear the cell of all items which could interfere with the operation of the manipulator.
Then turn the servo power ON.

Injury may result from unintentional or unexpected manipulator motion.

Fig. : Release of Emergency Stop



- Observe the following precautions when performing teaching operations within the P-point maximum envelope of the manipulator:
 - View the manipulator from the front whenever possible.
 - Always follow the predetermined operating procedure.
 - Keep in mind the emergency response measures against the manipulator's unexpected motion toward you.
 - Ensure that you have a safe place to retreat in case of emergency.

Improper or unintended manipulator operation may result in injury.

- Confirm that no person is present in the P-point maximum envelope of the manipulator and that you are in a safe location before:
 - Turning ON the power for the DX100.
 - Moving the manipulator with the programming pendant.
 - Running the system in the check mode.
 - Performing automatic operations.

Injury may result if anyone enters the P-point maximum envelope of the manipulator during operation. Always press an emergency stop button immediately if there is a problem.

The emergency stop buttons are located on the right of front door of the DX100 and the programming pendant.

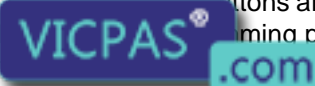

Everything for your HMI running

✉ sales@vicpas.com

☎ +86-15876525394

DX100



CAUTION

- Perform the following inspection procedures prior to conducting manipulator teaching. If problems are found, repair them immediately, and be sure that all other necessary processing has been performed.
 - Check for problems in manipulator movement.
 - Check for damage to insulation and sheathing of external wires.
- Always return the programming pendant to the hook on the cabinet of the DX100 after use.

The programming pendant can be damaged if it is left in the manipulator's work area, on the floor, or near fixtures.

- Read and understand the Explanation of Warning Labels in the DX100 Instructions before operating the manipulator:

Definition of Terms Used Often in This Manual

The MOTOMAN is the YASKAWA industrial robot product.

The MOTOMAN usually consists of the manipulator, the controller, the programming pendant, and supply cables.

In this manual, the equipment is designated as follows:

Equipment	Manual Designation
DX100 controller	DX100
DX100 programming pendant	Programming pendant
Cable between the manipulator and the controller	Manipulator cable

DX100

Descriptions of the programming pendant, buttons, and displays are shown as follows:

Equipment		Manual Designation
Programming Pendant	Character Keys	The keys which have characters printed on them are denoted with []. ex. [ENTER]
	Symbol Keys	The keys which have a symbol printed on them are not denoted with [] but depicted with a small picture. ex. page key  The cursor key is an exception, and a picture is not shown.
	Axis Keys Number Keys	“Axis Keys” and “Number Keys” are generic names for the keys for axis operation and number input.
	Keys pressed simultaneously	When two keys are to be pressed simultaneously, the keys are shown with a “+” sign between them, ex. [SHIFT]+[COORD]
	Displays	The menu displayed in the programming pendant is denoted with { }. ex. {JOB}

Description of the Operation Procedure

In the explanation of the operation procedure, the expression "Select ●●●" means that the cursor is moved to the object item and the SELECT key is pressed, or that the item is directly selected by touching the screen.

1	Conveyor Synchronized Function	1-1
1.1	System Configuration Example.....	1-1
1.2	Conveyor Synchronized Operation	1-2
1.2.1	Conveyor Home-position Limit Switch	1-3
1.2.2	Conveyor Home-position Input Signal	1-3
1.2.3	SYSTART Instruction and Manipulator Motion	1-3
1.3	Conveyor.....	1-5
1.3.1	Conveyor Form	1-5
1.3.2	Definition of Conveyor Moving Direction.....	1-6
1.3.3	Conveyor Distance for Follow-up.....	1-6
1.3.4	Measurement of Conveyor Moving Amount	1-6
2	Hardware Specifications	2-1
2.1	Required Boards and Setup.....	2-1
2.2	Connecting YCP02 Board to DX100.....	2-1
2.3	Connecting Conveyor Home-Position Signals to DX100	2-3
2.4	Applicable Encoder and Connection Specification	2-4
2.5	Connection Example of One Conveyor.....	2-5
2.6	Detecting Encoder Cable Disconnection	2-5
3	Connector Connection	3-1
3.1	Opening the Front Door	3-1
3.2	Sensor Cable Connection	3-2
3.3	Closing the Front Door.....	3-3
4	Settings for Conveyor Condition File.....	4-1
4.1	Conveyor Condition File.....	4-1
4.2	Editing Conveyor Condition File.....	4-10
4.2.1	Displaying Conveyor Condition File.....	4-10
4.2.2	Editing Conveyor Condition File	4-10
4.2.2.1	Editing "USED STATUS"	4-10
4.2.2.2	Editing "PORT NO."	4-10
4.2.2.3	Editing "BROKEN LINE DETECT"	4-10
4.2.2.4	Editing "ENCODER INPUT"	4-10
4.2.2.5	Editing "ENCODER SIGN"	4-10
4.2.2.6	Editing "CORRECTION"	4-11
4.2.2.7	Editing "TRA.....	4-11
4.2.2.8	Editing "USER.....	4-11

4.2.2.9	Editing "BASE AXIS"	4-11
4.2.2.10	Editing "POSITIONAL RESOLUTION"	4-11
4.2.2.11	Editing "VIRTUAL CONVEYOR SPEED"	4-11
4.2.2.12	Editing "AVERAGED TRAVEL TIME"	4-11
4.2.2.13	Editing "RESET SIGNAL MONITORING"	4-11
4.2.2.14	Editing "CONVEYOR SPEED DOWN MODE"	4-11
4.2.2.15	Editing "CONVEYOR LOWER LIMIT SPD"	4-11
4.2.2.16	Editing "VIRTUAL ENCODER INPUT"	4-12
4.2.2.17	Editing "VIRTUAL ENCODER OUTPUT"	4-12
4.3	Setting Conveyor Positional Resolution.....	4-13
4.3.1	Setting Conveyor Positional Resolution	4-14
4.3.2	Verifying and Adjusting Conveyor Positional Resolution.....	4-15
5	Teaching	5-1
5.1	Registering Instructions	5-1
5.1.1	SYSTART Instruction	5-1
5.1.1.1	Function	5-1
5.1.1.2	Format.....	5-2
5.1.1.3	Registering SYSTART Instruction.....	5-2
5.1.2	SYEND Instruction.....	5-4
5.1.2.1	Function	5-4
5.1.2.2	Format.....	5-4
5.1.2.3	Registering SYEND Instruction	5-4
5.1.3	SYMOV" Instruction.....	5-6
5.1.3.1	Function	5-6
5.1.3.2	Format.....	5-6
5.1.4	Interpolation Mode for Conveyor Synchronized Operation.....	5-7
5.1.4.1	Switching the Interpolation Mode	5-7
5.2	Motion Speed	5-8
5.3	Wrist Posture in Synchronization.....	5-10
5.4	Circular Interpolation Steps	5-11
5.5	Teaching.....	5-11
5.6	Teaching After Interruption of Playback in Synchronized Operation	5-14
5.6.1	When Adding or Changing Step After Interruption of Synchronized Operation..	5-14
5.6.2	When Performing Another Teaching (for Other Workpiece).....	5-15
5.7	Notes on Operation.....	5-17
5.7.1	Confirming Reach to Step	5-17
5.7.2	Backward (BWD) Operation	5-17
5.7.3	Changing Tool	5-17

5.7.4	Deleting Taught Points	5-17
5.8	Job Example	5-18
6	Playback.....	6-1
6.1	Conveyor Speed Down	6-1
6.2	Accuracy	6-2
6.3	Conveyor Resolution Error.....	6-2
6.4	Restarting Synchronization After Manipulator Stops	6-3
6.5	Continuance of Conveyor Synchronized Status	6-3
6.6	Continuance of Parallel Shift Status	6-3
6.7	Conveyor Synchronized Operation During Execution of TIMER and WAIT	6-3
7	Conveyor Monitoring Windows	7-1
7.1	Conveyor Position Window	7-2
7.2	Conveyor Speed Window	7-3
7.3	Conveyor Tracking Status Window.....	7-4
8	Virtual Encoder Mode.....	8-1
8.1	Virtual Encoder Pulse Count.....	8-1
8.2	Relation Between Encoder Input and Virtual Encoder Input.....	8-1
8.3	Precaution on Switching the Encoder Mode	8-1
9	Turntable Synchronized Function	9-1
9.1	Setting Up the Turntable Synchronized System	9-1
9.1.1	Settings for Conveyor Condition File	9-1
9.1.2	Calibration between Manipulator and Turntable	9-2
9.1.2.1	Setting a Calibration Tool	9-2
9.1.2.2	Teaching Calibration Position.....	9-3
9.1.2.3	Operating Calibration.....	9-3
9.2	Modifying Instructions	9-6
10	Manual Conveyor Function	10-1
10.1	Settings for Manual Conveyor Function.....	10-2
10.1.1	Setting the Conveyor Position	10-2
10.1.2	Enabling/Disabling the Setting.....	10-2
10.2	Precautions	10-2
10.2.1	When the Power is	10-2

11	Manual Setting Function for Conveyor Home-Position Limit Switch.....	11-1
12	Instruction List.....	12-1
13	Alarm List.....	13-1
14	Sensor Parameters (SxE).....	14-1

1 Conveyor Synchronized Function

1.1 System Configuration Example

A basic system configuration example using DX100 conveyor synchronized function is shown below.

The manipulator detects the conveyor moving amount by the encoder mounted on the conveyor.

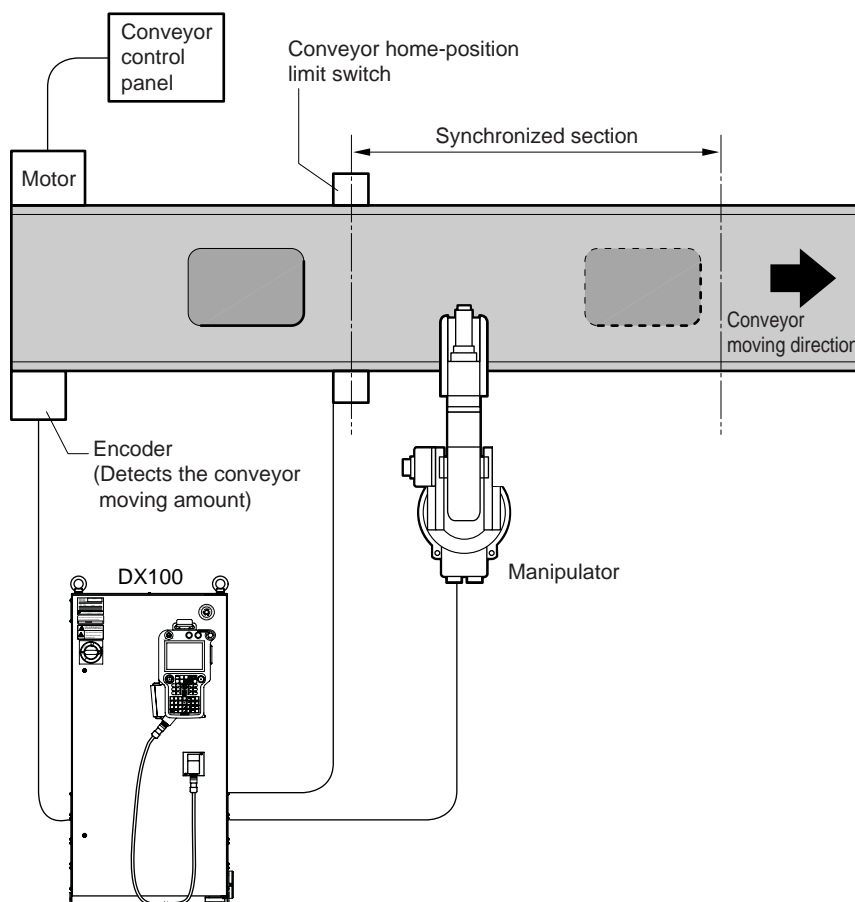

Fig. 1-1: System Configuration Example for Conveyor Synchronized Operation

1.2 Conveyor Synchronized Operation

The position tracking type conveyor synchronized operation function modifies the taught path in conveyor non-moving state according to the conveyor moving amount so that the manipulator performs follow-up motion in the conveyor moving direction with constant speed relative to the workpiece.

For example, teach P1 to P7 (P2 to P6 are the points in synchronization) with the conveyor stopped. In playback operation, the manipulator follows the conveyor (workpiece) with the motion path modified in the conveyor moving direction as shown in the "Fig.1- 2 (b) Synchronized Motion Path in Playback Mode".

The conveyor synchronized function can use either the manipulator base axis or the traveling axis (external axis) to follow the movement of conveyor. However, the base axis and the traveling axis can not be selected simultaneously.

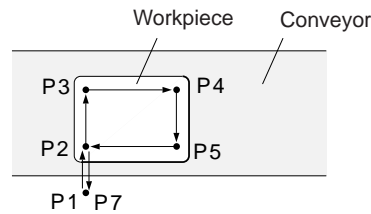
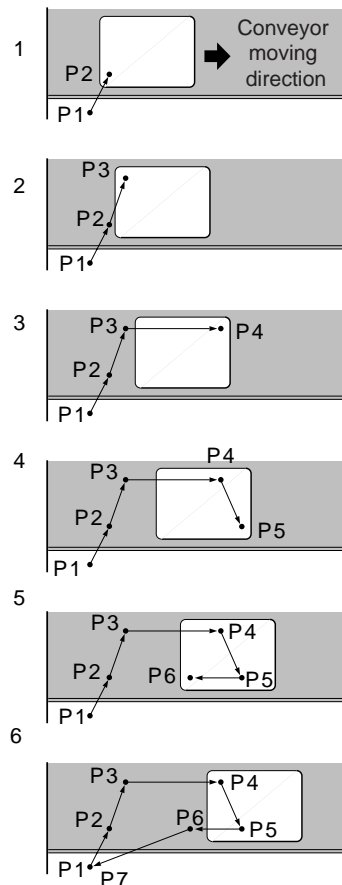

Fig. 1-2(a): Teaching



Synchronized Motion Path in Playback Mode

VICPAS.com
 Everything for your HMI running
 sales@vicpas.com
 +86-15876525394

DX100

- 1 Conveyor Synchronized Function
- 1.2 Conveyor Synchronized Operation

1.2.1 Conveyor Home-position Limit Switch

The conveyor home-position limit switch turns ON the conveyor home-position input signal when a workpiece is detected by a sensor.

1.2.2 Conveyor Home-position Input Signal

When the conveyor home-position input signal is input, the conveyor current value is automatically reset to 0 mm.

Then, the manipulator can enter synchronized operation status by execution of SYSTART instruction.

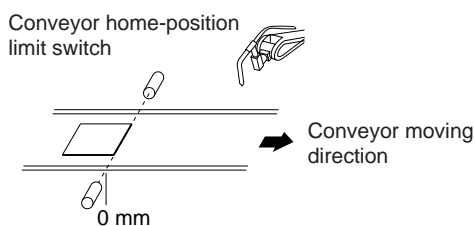

1.2.3 SYSTART Instruction and Manipulator Motion

The SYSTART is a conveyor synchronized operation start instruction.

Format: SYSTART CV#(1) <STP= Synchronization start position (units: mm)>

After having executed the SYSTART instruction, when the conveyor reaches the position specified at STP as the synchronization start position, the manipulator enters the synchronized operation status. Up to this moment, the manipulator does not move.

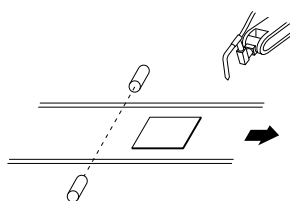

When a workpiece reaches the position set as the synchronization start position, the manipulator starts the synchronized operation.

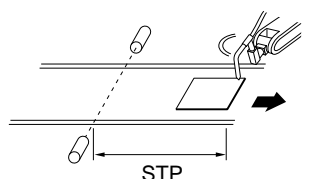

(The distance to the synchronization start point)

1 Conveyor Synchronized Function
 DX100 1.2 Conveyor Synchronized Operation

If the SYSTART instruction is executed before the input of conveyor home-position input signal, the manipulator waits until the conveyor home-position input signal is input and the conveyor reaches the synchronization start position, then starts the synchronized operation.

If the conveyor home-position input signal is input before the execution of SYSTART instruction, the manipulator waits until the conveyor reaches the synchronization start position, then enters in synchronized operation status.

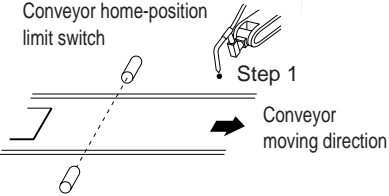
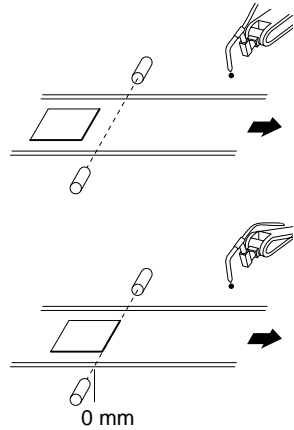
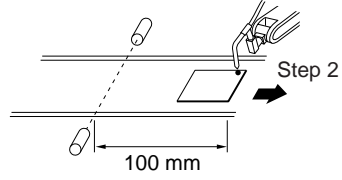
Job	Manipulator	Motion
MOVJ	: Moves to Step 1	
SYSTART CV#(1) STP=100.00	: Stops, and waits until the conveyor reaches "STP = 100".	
SYMOVL	: Moves to Step 2 in the conveyor synchronized operation after the conveyor position has come to 100 mm.	

DX100	1	Conveyor Synchronized Function
	1.3	Conveyor

<Job Example>

A job example of conveyor synchronized operation is shown. Refer to Section 5.11 "Job Example".

```

0000 NOP
0001 SYEND CV#(1)..... Resets the conveyor home-position registration status
0002 MOVJ.....Moves to the stand-by position near the conveyor
0003 SYSTART CV#(1) STP=100.000...Conveyor synchronized operation starts.
0004 GETS B000 $B008
0005 JUMP *END IF B000=0
0006 SYMOVL CV#(1) CTP=50.000
0007 SYMOVL CV#(1) CTP=50.000 } ...Conveyor synchronized motion
0008 SYMOVL CV#(1) CTP=50.000 } (Linear interpolation)
0009 SYMOVL CV#(1) CTP=50.000 }
0010 *END
0011 SYEND CV#(1).....Conveyor synchronized operation ends.
0012 MOVJ.....Returns to the stand-by position
0013 END
    
```

Synchronized operation section

1.3 Conveyor

1.3.1 Conveyor Form

There are three types of the conveyor tracking motion: robot-axis tracking, base-axis tracking, and circular tracking.

Each type must be set according to its system configuration (tracking motion type).

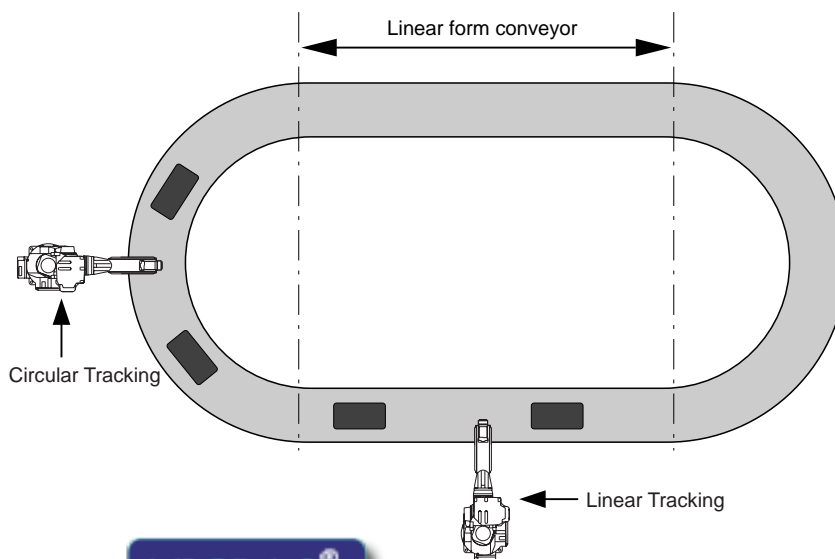

 Everything for your HMI running
 ✉ sales@vicpas.com
 ☎ +86-15876525394

	1	Conveyor Synchronized Function
DX100	1.3	Conveyor

1.3.2 Definition of Conveyor Moving Direction

The conveyor moving amount pulses detected by the encoder mounted on the conveyor are scalar. From this number of pulses, the manipulator determines how far to move, but not in which direction. Therefore, the conveyor moving direction must be defined for the manipulator. For the definition of moving direction, a user coordinate is used. (Refer to “[⑧ TRACKING \(ROBOT-AXIS/BASE-AXIS/CIRCULAR\)](#)”).



For registration of user coordinates, refer to “DX100 INSTRUCTIONS”.

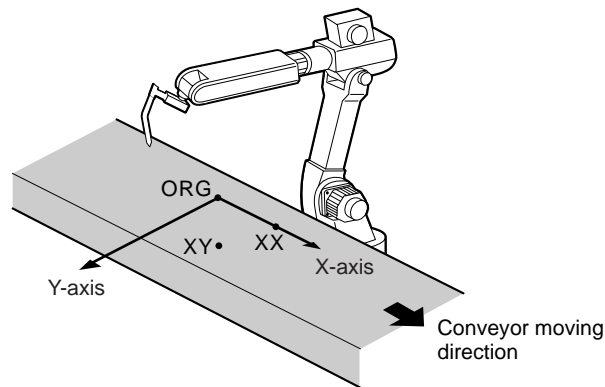

1.3.3 Conveyor Distance for Follow-up

With the conveyor synchronized function of DX100, a manipulator can synchronize a conveyor continuously over a maximum distance of 21 m within the manipulator working envelop.

Since the distance more than 21 m can not be processed internally, if the moving distance reaches 21 m during synchronized operation, the alarm 5022 “CONVEYOR POSITION LIMIT” occurs and the manipulator stops disregarding the succeeding synchronization.

1.3.4 Measurement of Conveyor Moving Amount

How far the conveyor has moved from the conveyor home-position is measured by the cumulative number of feedback pulses from the encoder mounted on the conveyor. The accumulation starts when the conveyor home-position limit switch is turned ON. At the start, the cumulative amount is zero (0).

DX100	2	Hardware Specifications
	2.1	Required Boards and Setup

2 Hardware Specifications

This chapter explains the required equipment and boards to use the conveyor synchronized function, as well as what data are required and how they should be set. Before setting up a system, read carefully this chapter.

2.1 Required Boards and Setup

For the conveyor synchronized function, the optional base board JANCD-YCP02 is required besides the standard boards.

Three encoder signal input ports are provided on the YCP02 board. (Note that the connectors are unified in one.)

Up to three conveyor encoders can be connected to a single YCP02 board.

2.2 Connecting YCP02 Board to DX100

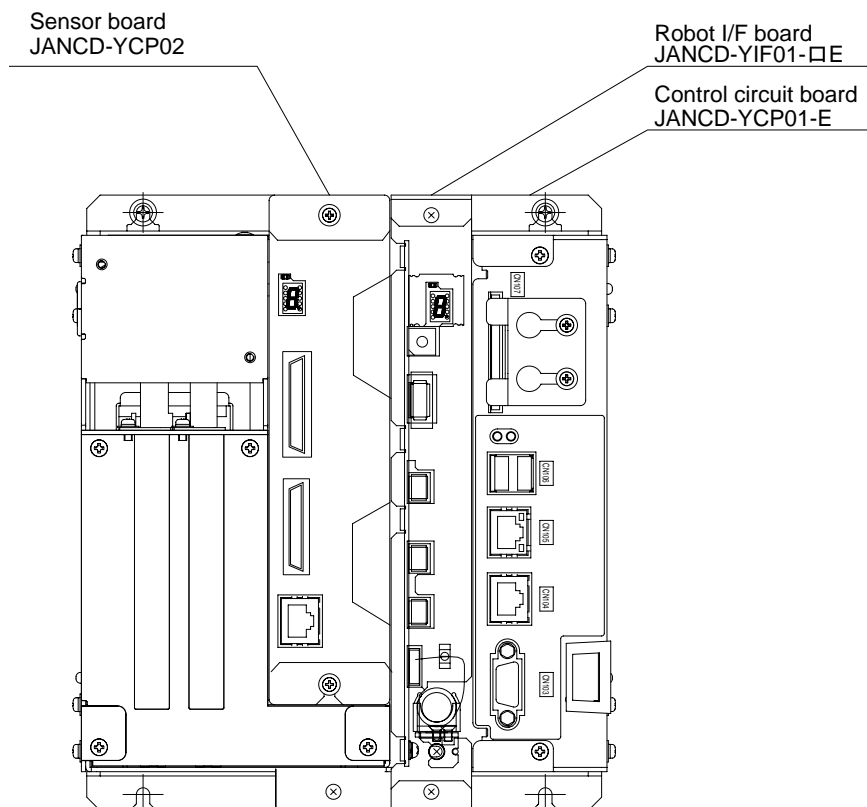

2 Hardware Specifications
2.2 Connecting YCP02 Board to DX100

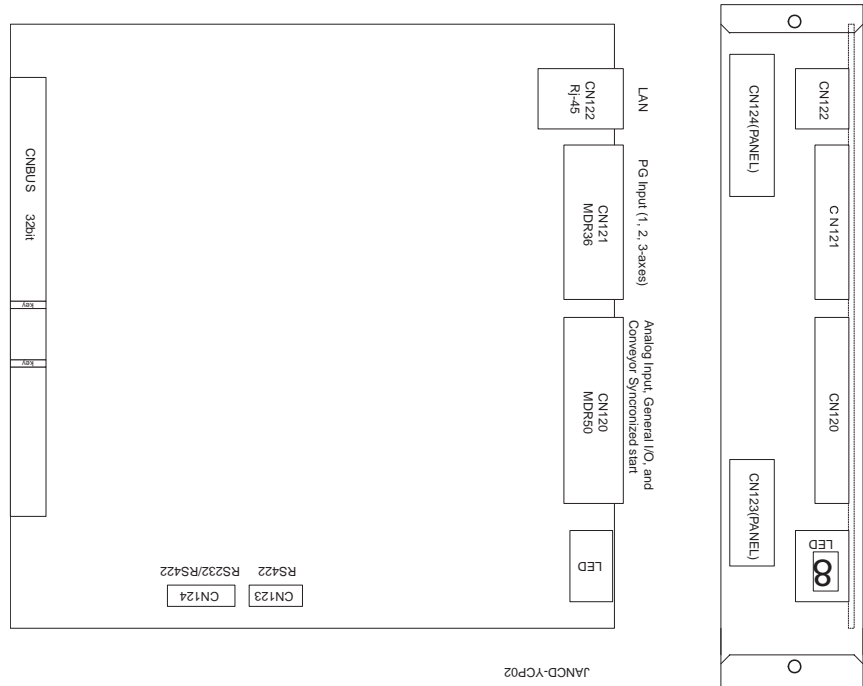

2.3 Connecting Conveyor Home-Position Signals to DX100

The conveyor home-position input signals are connected through each encoder input port on the JANCD-YCP02 board. Since the conveyor home-position input signals are used for the reference to the conveyor position, they must be as in phase as possible. It is recommended to connect the conveyor home position signal from the conveyor home-position limit switch directly to the DX100 so as to eliminate dispersion caused by sequencer scan time errors. Input the conveyor home-position limit switch signals to the corresponding conveyor port channels as shown in the figure below so that each signal will not be received while the corresponding channel is executing synchronization.

Check whether the conveyor home-position input signals function correctly on the conveyor condition file window explained later.

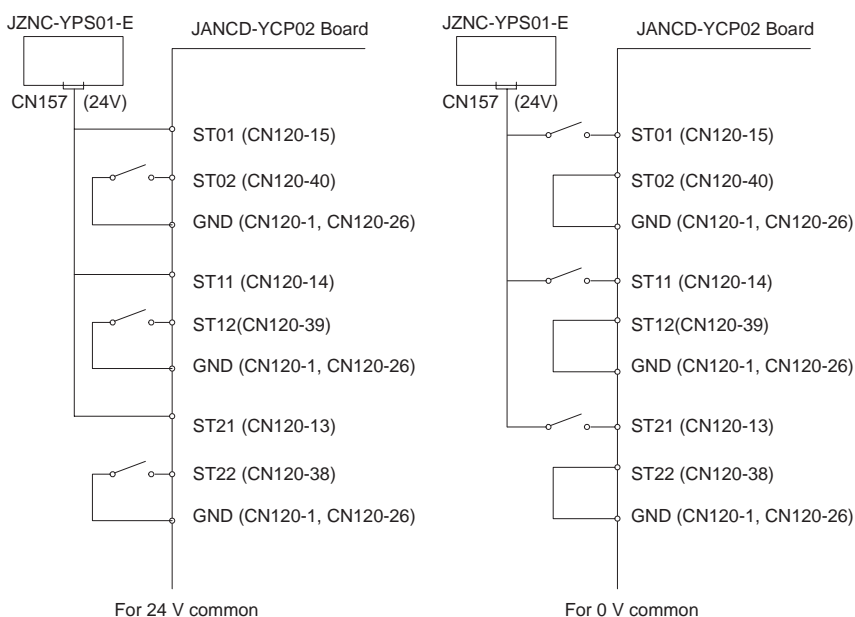

2.4 Applicable Encoder and Connection Specification

For DX100 conveyor synchronized function, use a conveyor encoder with two-phase line driver outputs (equivalent to RS422). Encoders with open-collector output or signal-phase output are not applicable.

The connection of encoder to the YCP02 board is as shown below. Check if the encoder operates correctly on the conveyor position window explained later.

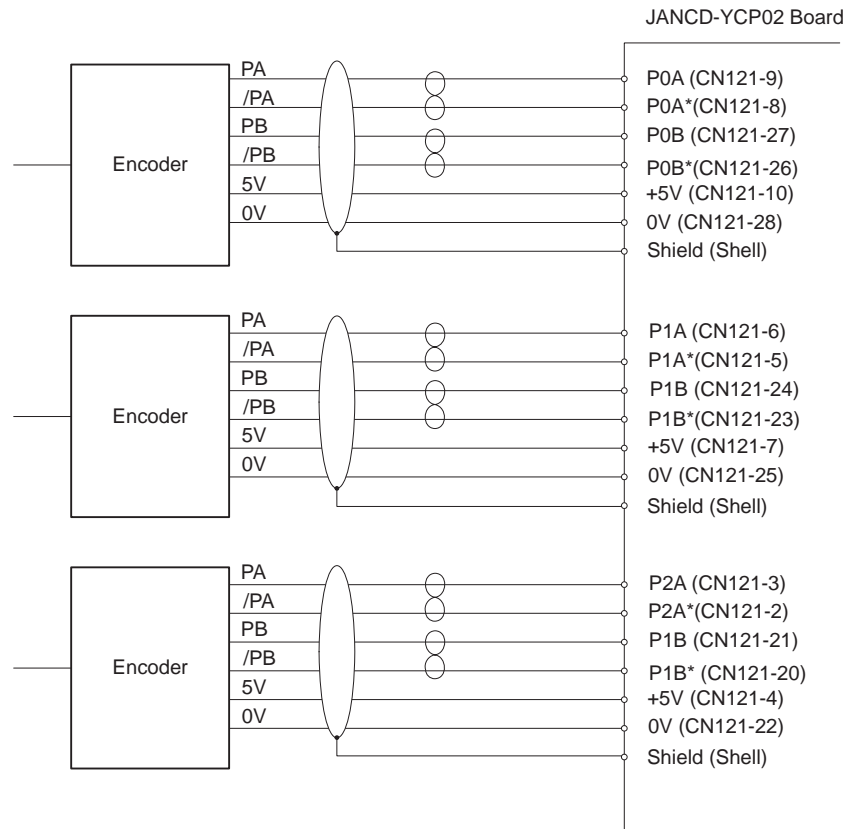

For 5 V encoder with line driver, PREA-3C3□/□□ manufactured by Yaskawa Control is recommended.

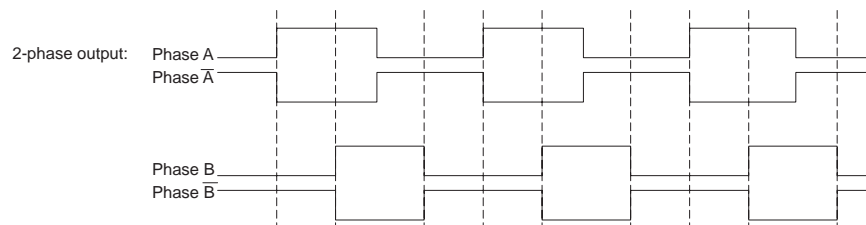

2.5 Connection Example of One Conveyor

A connection example of one conveyor is shown below. Use a cable of 0.2 pt size.

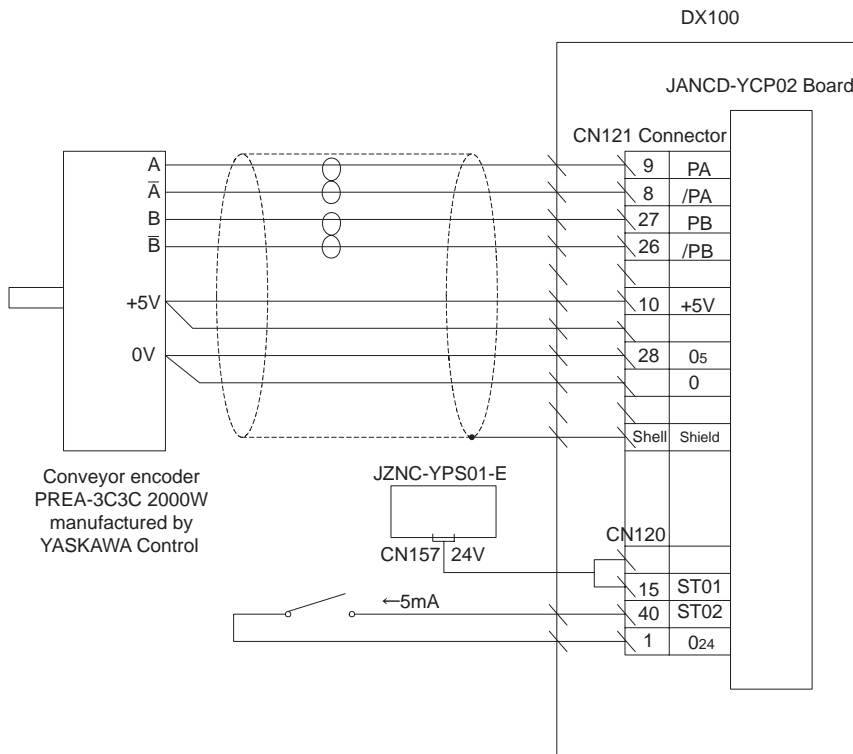

2.6 Detecting Encoder Cable Disconnection

With the conveyor synchronized function, at disconnection of encoder cable, the alarm 1400 “ENCODER ERROR (CONVEYOR)” occurs and the servo power supply is shut down.

3 Connector Connection

3.1 Opening the Front Door

Open the front door of the DX100.

1. Turn the two door locks on the front face of the DX100 clockwise by 90 ° by using a coin or flat tip screwdriver.

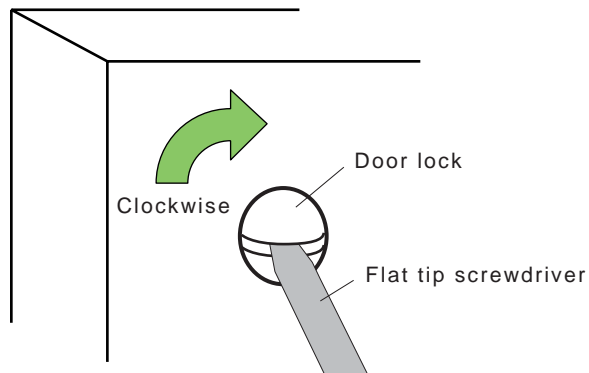

2. With the door locks turned clockwise by 90 °, turn the main switch handle to the “OFF” position, and then gently open the door.

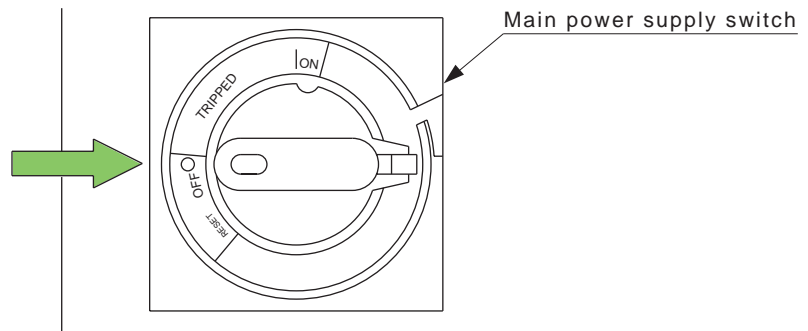

3.2 Sensor Cable Connection

Connect the cable from the sensor to the YCP02 board.

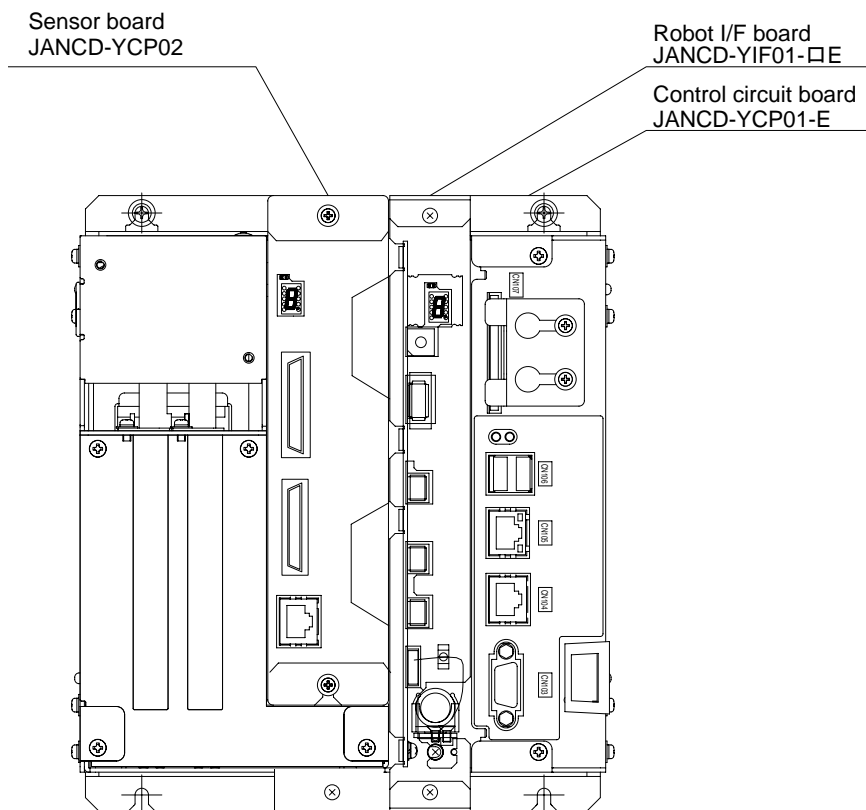

Cable Connection to YCP02 Board

NOTE Be sure to securely tighten the connectors with a screwdriver.

3.3 Closing the Front Door

Close the front door of the DX100.

1. Gently close the door of the DX100.

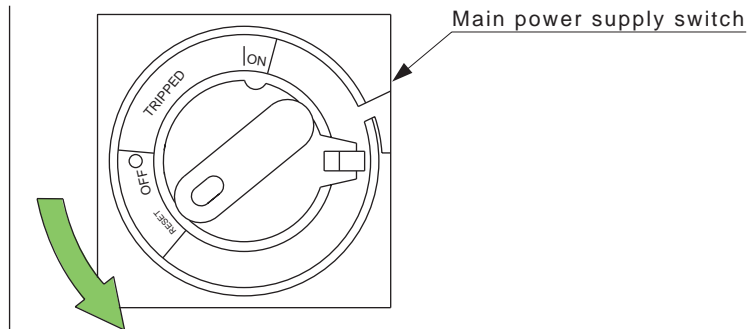

2. Turn the two door locks counterclockwise by 90°.

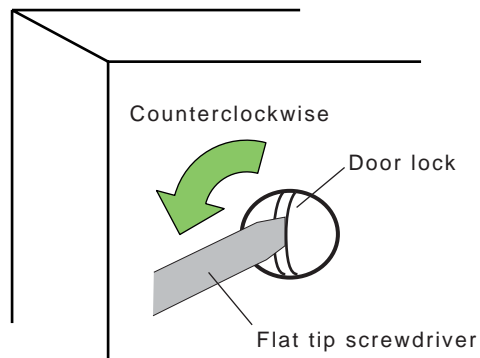

To ensure the dust resistance, be sure to securely close the door of the DX100.

4 Settings for Conveyor Condition File

4.1 Conveyor Condition File

For proper operation of conveyor synchronized function, the data of conveyor must be provided to the DX100 by setting them in the conveyor condition files.

There are six conveyor condition files from File No. 1 to 6. Up to three files can be used for each JANCD-YCP02 board for conveyor synchronized operation. In the system with one JANCD-YCP02 board, up to three files from File No. 1 to 3 can be set.

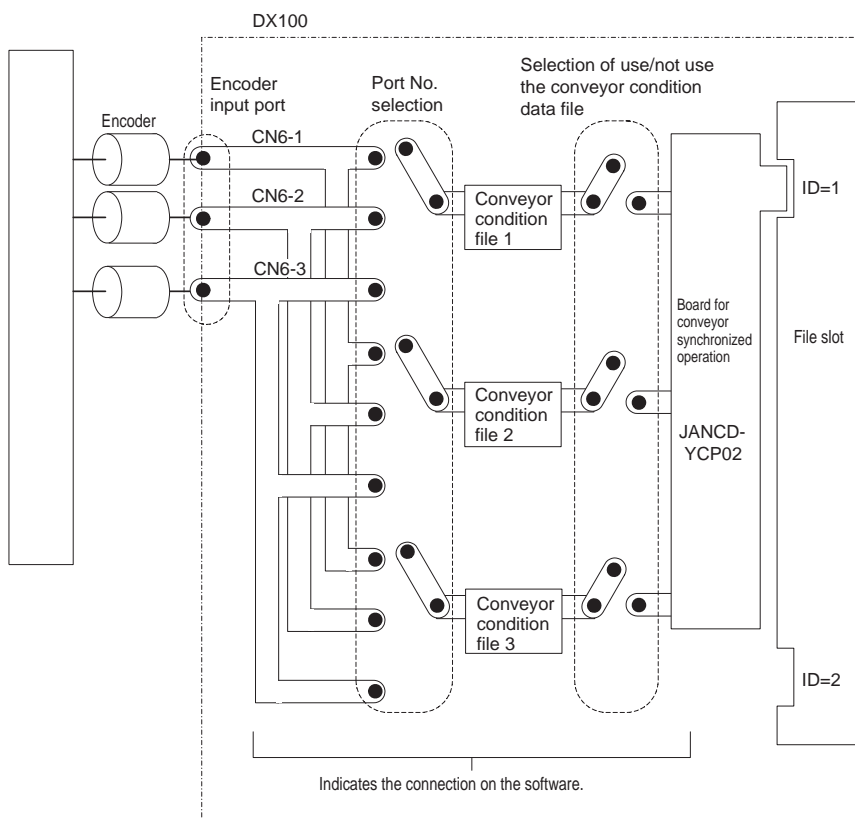

Relevancy of Conveyor Condition Files

4 Settings for Conveyor Condition File
 4.1 Conveyor Condition File

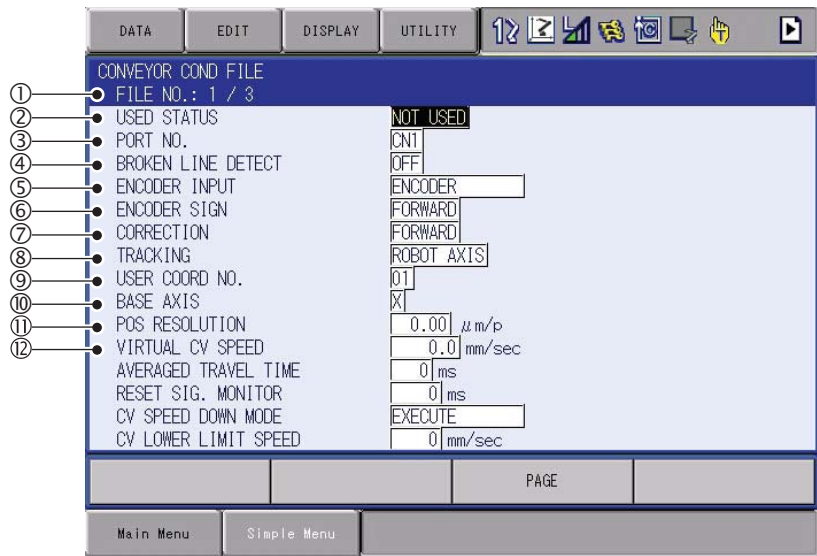

① FILE NO.

Indicates the conveyor condition file No.

Board for Conveyor Synchronized Operation JANCD-YCP02	Number of Boards	File No.
	1	1 to 3
	2	1 to 6

② STATUS OF USE (USED/NOT USED)

Select whether to use the conveyor condition file or not.

③ PORT NO. (CN1/CN2/CN3)

Specify the port number of which the encoder in use is connected.

④ BROKEN LINE DETECT (ON/OFF)

Select whether to use disconnection detection or not.

⑤ ENCODER INPUT (ENCODER/VIRTUAL ENCDR)

Select whether the synchronization is to be carried out with actual encoder input or virtual pulse encoder.

When "VIRTUAL ENCDR" is selected, the manipulator can perform synchronization even when no encoder is connected or the conveyor is not in operation. This function is convenient for operation check in test run.

4 Settings for Conveyor Condition File
 4.1 Conveyor Condition File

⑥ ENCODER SIGN (FORWARD/REVERSE)

Select whether to invert the sign of encoder position pulse input from encoder or not.

When "REVERSE" is specified, the signs of data on the windows of conveyor position and conveyor speed are inverted, and the synchronized direction of the manipulator is reversed.

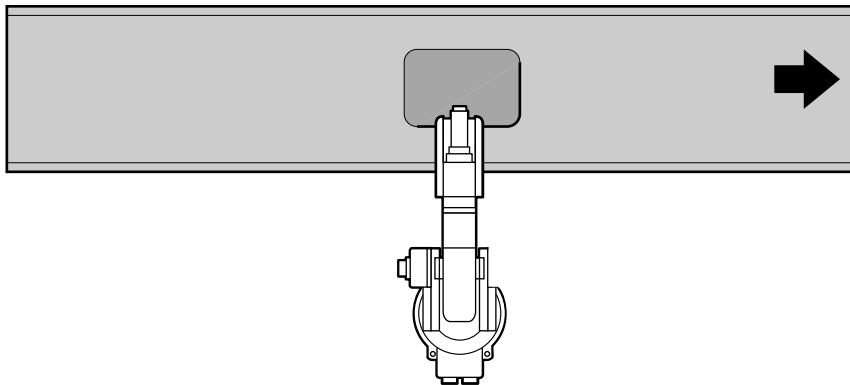

Conveyor Motion (From 1000 pulses to 2000 pulses)



⑦ CORRECTION (FORWARD/REVERSE)

Specify whether to reverse the synchronized direction or not.

When "REVERSE" is selected, the sign of correction position on the conveyor speed window is inverted and the manipulator synchronizes in the reverse direction.

When "BASE AXIS" (explained in the item ⑧) is selected for "TRACKING"

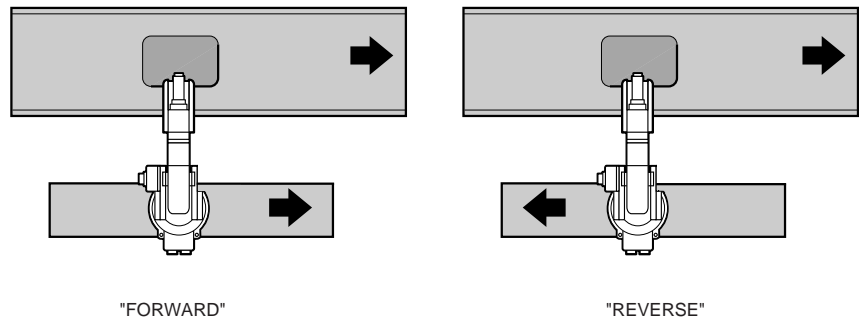

⑧ TRACKING (ROBOT-AXIS/BASE-AXIS/CIRCULAR)

Specify whether to carry out the synchronization with the robot-axis or the base-axis (servo track).

If "BASE AXIS" is selected for the system without base axis, no synchronized motion can be performed.

Robot axis: Teach three points as P1, P2 and P3 on the conveyor as reference points of user coordinate as shown in the figure below. Set the X-axis of user coordinate to the conveyor moving direction.

Register these user coordinates in "USER COORD NO." of the conveyor condition file so that the manipulator synchronizing direction is the conveyor moving direction.



- For registration of user coordinates, refer to "DX100 INSTRUCTIONS".
- For details of circular tracking, refer to "9 Turntable Synchronized Function".

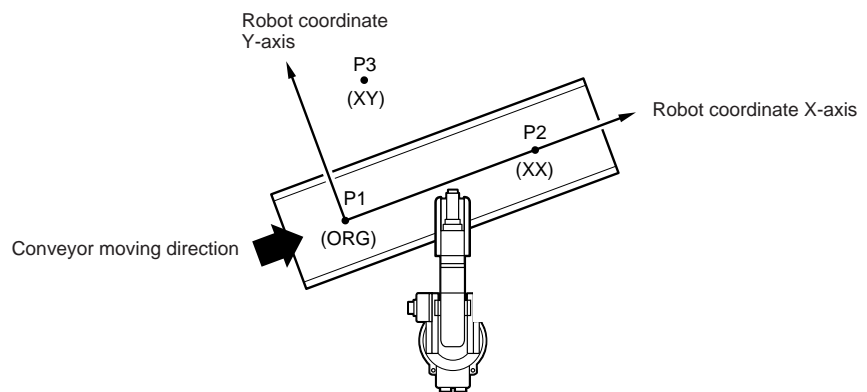

ORG: User coordinate home position
 XX: Point to define user coordinate X-axis
 XY: Point to define user coordinate Y-axis

Base axis: Select a base axis (servo track) among X, Y, or Z-axis, which is parallel to the conveyor. In this case, the conveyor moving direction does not need to be defined in a user coordinate.

VICPAS .com

Everything for your HMI running

✉ sales@vicpas.com

☎ +86-15876525394

4 Settings for Conveyor Condition File
4.1 Conveyor Condition File

the robot coordinate axis are shown below.

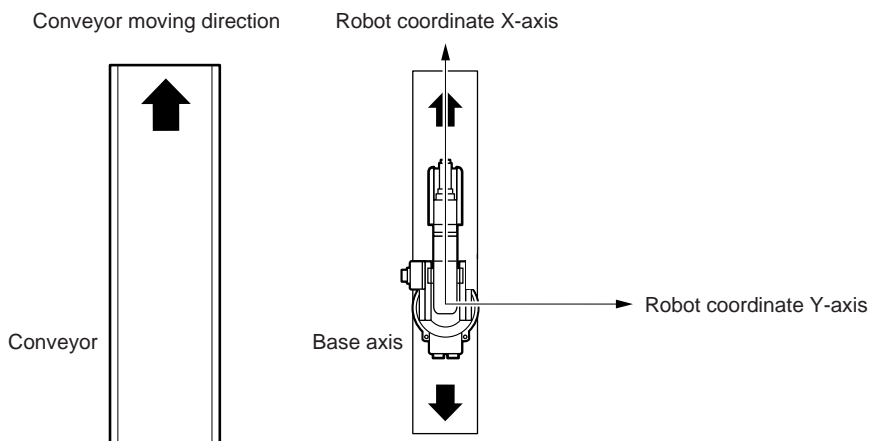

When Synchronized by Servo Track X-axis

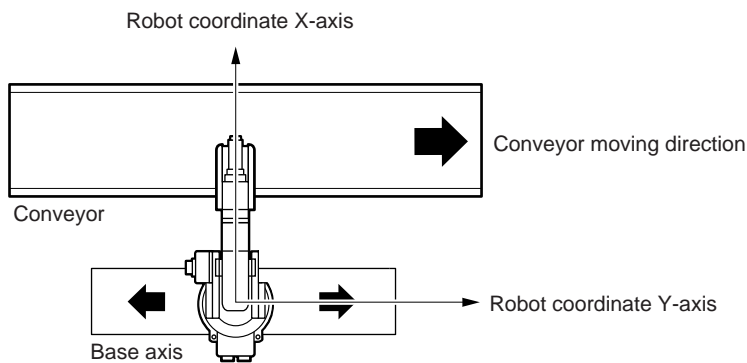

When Synchronized by Servo Track Y-axis

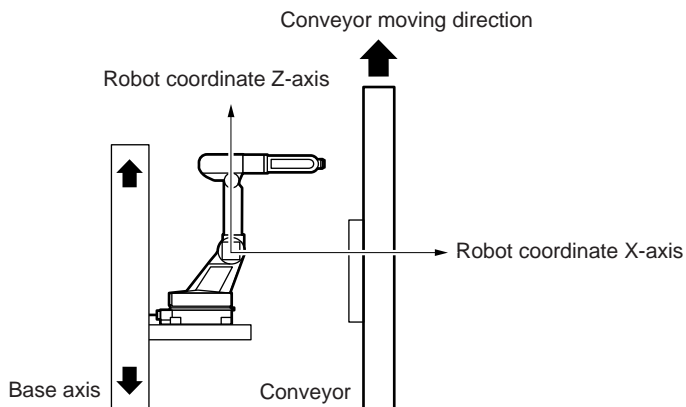

When Synchronized by Traveling Axis Z-axis

4 Settings for Conveyor Condition File
 4.1 Conveyor Condition File

⑨ USER COORD NO. (1 to 24)

When "ROBOT AXIS" is selected in ⑧, specify with which X-axis direction of user coordinate is to be carried out for the synchronization by selecting the user coordinate number.

⑩ BASE AXIS (X/Y/Z)

When "BASE AXIS" is selected in ⑧, specify with which base axis the manipulator is to be synchronized among X, Y, or Z-axis.

⑪ POSITIONAL RESOLUTION (0.01 to 999.99 μm)

The data for converting 1 pulse from encoder to the conveyor moving amount (μm). For details of setting method, refer to "4.3 Setting Conveyor Positional Resolution".

⑫ VIRTUAL ENCODER SPEED (-3276.8 to +3276.7 mm/sec)

Set the virtual encoder speed when "VIRTUAL ENCODER" is selected in ⑤.

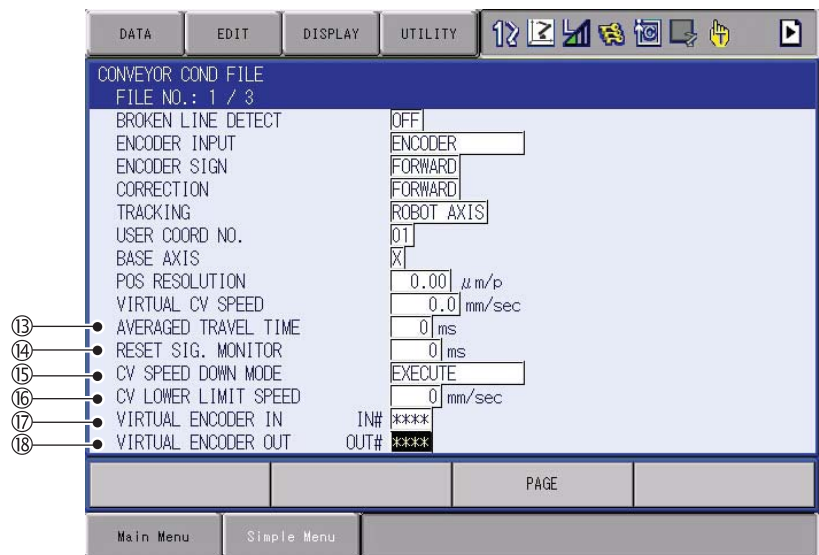

⑬ AVERAGED TRAVEL TIME (0 to 3000 ms)

At sudden change in the conveyor moving amount, the moving amounts is automatically averaged so that the manipulator moves smoothly. However, the synchronization responsiveness is lowered in this case. When the conveyor motion is not smooth, set the value to approx. "200". When this function is not used, set at "0".

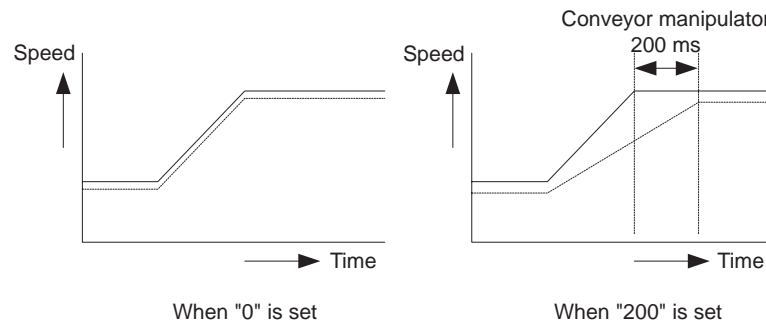

⑭ RESET SIGNAL MONITORING (0 to 65535 ms)

Set a time to wait for the conveyor home-position input signal when no encoder reset signal for a specified conveyor has been input at the execution of SYSTART instruction.

When the waiting time exceeds the set value, the SYSTART instruction is aborted and the next instruction is executed. Therefore, prepare the job so that the manipulator takes retreat motion by internal status.

When "0" is set, the system waits for the conveyor home-position input signal without being interrupted by the time limit for encoder reset signal monitoring.

⑮ CONVEYOR SPEED DOWN MODE (EXECUTE/ALARM/ PAUSE JOB)

Specify the manipulator motion when the conveyor speed is reduced lower than the conveyor lower speed limit specified in ⑯.

EXECUTE: The manipulator is operative regardless of the conveyor speed. Accordingly, when the conveyor stops, the manipulator performs the synchronized operation with the conveyor speed 0.

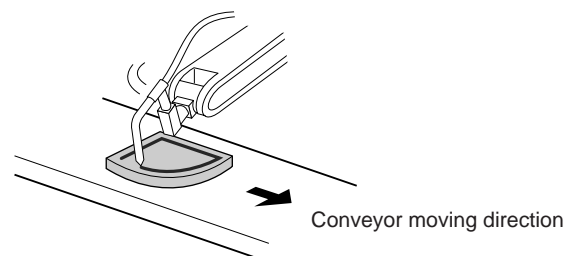

ALARM: When the conveyor averaged speed is so lowered that it becomes below the set value in “CONVEYOR LOWER LIMIT SPD” of the conveyor condition file continuously for 0.1 second, an alarm occurs and the manipulator stops. This mode is used where a conveyor stop detection mechanism does not exist in the conveyor control board.

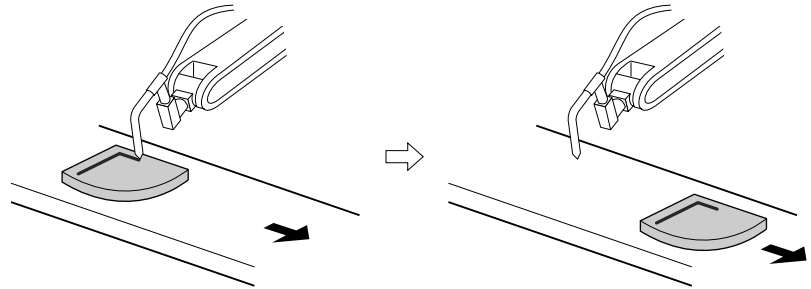

When the conveyor speed is lowered below the conveyor lower limit speed, an alarm occurs and the manipulator stops.

PAUSE JOB: When the conveyor speed is so lowered that it becomes below the set value in “CONVEYOR LOWER LIMIT SPD” of the conveyor condition file continuously for 0.1 second, the job motion is interrupted and the manipulator performs only the follow-up motion in the conveyor moving direction. Then, when the conveyor speed is recovered to the set value in “CONVEYOR LOWER LIMIT SPD” and higher continuously for 0.1 second, the job execution restarts. In this case, only the execution of move instructions in the job are suppressed.

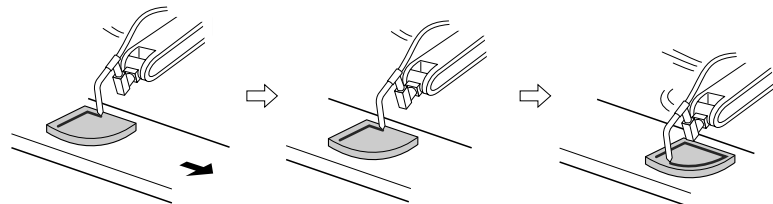

When the conveyor speed is lowered below the conveyor lower limit speed, the execution of move instruction in the job is interrupted and the manipulator performs only the follow-up motion in the conveyor moving direction.

When the conveyor speed is recovered and become higher than the conveyor lower limit speed, the execution of job restarts.

⑩ CONVEYOR LOWER LIMIT SPD (0 to 65535 mm/sec)

This value is used when “ALARM” or “PAUSE JOB” is selected in ⑮. When the conveyor speed becomes lower than this value, the manipulator will be in the “ALARM” mode or “PAUSE JOB” mode.

DX100

-
- 4 Settings for Conveyor Condition File
 - 4.1 Conveyor Condition File
-

⑰ VIRTUAL ENCODER INPUT (IN#000 to IN#1024)

When the general purpose input signal of the number which is set in “VIRTUAL ENCODER INPUT” is input, the encoder input enters the virtual encoder mode.

The virtual encoder input signal is used to operate the manipulator with the conveyor stopped in the simulation of conveyor system operation.

IN#000: Not used

IN#001 to IN#1024: The set general purpose input signal is valid.

⑱ VIRTUAL ENCODER OUTPUT (OUT#000 to OUT#1024)



If “VIRTUAL ENCDR” is selected in ⑤, the output signal of the number which is set in “VIRTUAL ENCODER OUTPUT” is output.

OUT#000: Not used

OUT#001 to OUT#1024: The set signal is output.

4.2 Editing Conveyor Condition File

4.2.1 Displaying Conveyor Condition File

1. Select {ROBOT} under the top menu.
2. Select {CV CONDITION}.
3. Display a desired conveyor condition file.
 - Press the page key  . The next file No. is called.
 - Press [SHIFT] + the page key  . The previous file No. is called.

4.2.2 Editing Conveyor Condition File

4.2.2.1 Editing "USED STATUS"

1. Select "USED STATUS"
2. "USED" and "NOT USED" switch alternately.

4.2.2.2 Editing "PORT NO."

1. Select "PORT NO.".
2. The selection dialog appears.
3. Select a desired port number.

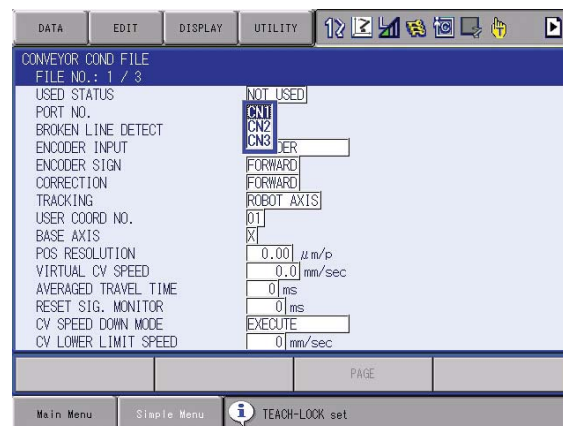

4.2.2.3 Editing "BROKEN LINE DETECT"

1. Select "BROKEN LINE DETECT".
2. "OFF" and "ON" switch alternately.

4.2.2.4 Editing "ENCODER INPUT"

1. Select "ENCODER INPUT".
2. "ENCODER" and "VIRTUAL ENCDR" switch alternately.

4.2.2.5 Editing "ENCODER SIGN"

1. Select "ENCODER SIGN".
2. "FORWARD" and "REVERSE" switch alternately.

	4	Settings for Conveyor Condition File
DX100	4.2	Editing Conveyor Condition File

4.2.2.6 Editing "CORRECTION"

1. Select "CORRECTION"
2. "FORWARD" and "REVERSE" switch alternately.

4.2.2.7 Editing "TRACKING"

1. Select "TRACKING"
2. The selection dialog appears.
3. Select a desired method.

4.2.2.8 Editing "USER COORD NO."

1. Select "USER COORD NO."
2. Enter a value using the numeric keys.

4.2.2.9 Editing "BASE AXIS"

1. Select "BASE AXIS".
 - Editable only if "BASE AXIS" has been selected as a tracking method.
2. The selection dialog appears.
3. Select a desired axis.

4.2.2.10 Editing "POSITIONAL RESOLUTION"

1. Select "POSITIONAL RESOLUTION".
2. Enter a value using the numeric keys.

4.2.2.11 Editing "VIRTUAL CONVEYOR SPEED"

1. Select "VIRTUAL CONVEYOR SPEED".
2. Enter a value using the numeric keys.

4.2.2.12 Editing "AVERAGED TRAVEL TIME"

1. Select "AVERAGED TRAVEL TIME".
2. Enter a value using the numeric keys.

4.2.2.13 Editing "RESET SIGNAL MONITORING"

1. Select "RESET SIGNAL MONITORING".
2. Enter a value using the numeric keys.

4.2.2.14 Editing "CONVEYOR SPEED DOWN MODE"

1. Select "CONVEYOR SPEED DOWN MODE".
2. The selection dialog appears.
3. Select a desired mode.

4.2.2.15 Editing "CONVEYOR LOWER LIMIT SPD"

1. Select "CONVEYOR LOWER LIMIT SPD".
2. Enter a value using the numeric keys.

	4	Settings for Conveyor Condition File
DX100	4.2	Editing Conveyor Condition File

4.2.2.16 Editing "VIRTUAL ENCODER INPUT"

1. Select "VIRTUAL ENCODER INPUT".
2. Enter a value using the numeric keys.

4.2.2.17 Editing "VIRTUAL ENCODER OUTPUT"

1. Select "VIRTUAL ENCODER OUTPUT".
2. Enter a value using the numeric keys.

4.3 Setting Conveyor Positional Resolution

The encoder mounted on the conveyor sends a pulse amount as the conveyor current position. In order that the manipulator recognizes this pulse amount as the conveyor moving amount for its synchronized motion, the pulse amount must be converted into a distance.

The conveyor moving amount (μm) per 1 pulse to be used for this conversion is called "POSITIONAL RESOLUTION".

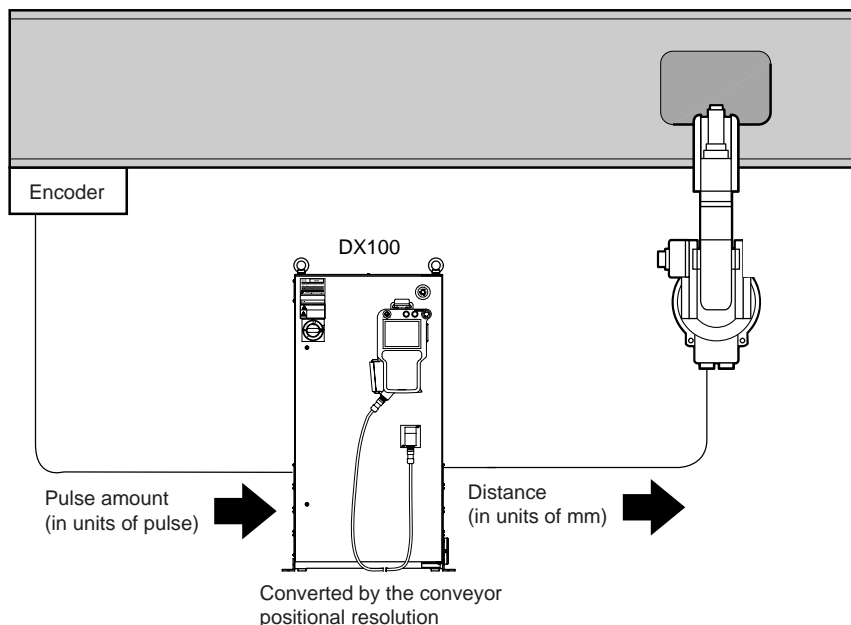

POSITIONAL RESOLUTION	240.00 μp
-----------------------	----------------------

Conveyor Condition File Window

The conveyor positional resolution is set in units of μ . For example, when the positional resolution is $30 \mu\text{/pulse}$, set "30.00" in POSITIONAL RESOLUTION".

The setting range is from 0 to 999.99μ . Since the DX100 internally quadruples every encoder pulse number, the actual conveyor positional resolution for the conveyor encoder is up to $3999.96 \mu\text{/pulse}$.

As the resolution error accumulates for the conveyor moving pulse amount, the setting must be made correctly. For example, setting the resolution $0.01 \mu\text{/pulse}$ bigger causes the follow-up error of 0.1 mm at the point that the conveyor moves for 10000 pulses.

The conveyor resolution is mentioned in the specification of each conveyor, however, the value cannot be used as it is for the reasons explained below. Measure the actual conveyor resolution in the following manner.

NOTE

The DX100 internally quadruples the feedback pulse from the conveyor encoder. Accordingly, the conveyor positional resolution in the conveyor condition file is 1/4 of the conveyor resolution on your conveyor specification.

Everything for your HMI running

✉ sales@vicpas.com

☎ +86-15876525394

4.3.1 Setting Conveyor Positional Resolution

Set the conveyor positional resolution in the following manner.

1. Select {ROBOT} under the top menu, then select {CV MONITOR}.
 - The conveyor position window appears.
2. Take note of the current value (pulses) of the conveyor axis to be used as C1 (pulses).
 - At this moment, the conveyor should be in stop status.

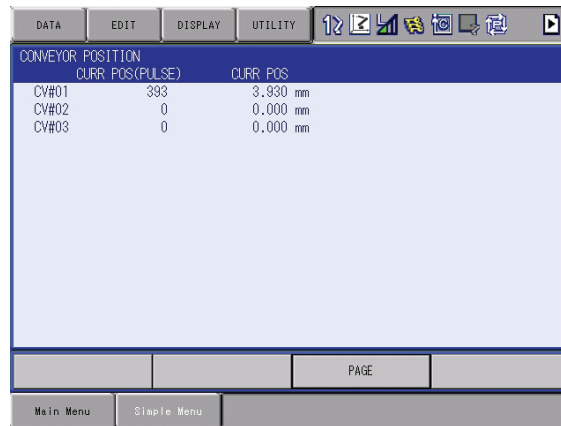

CONVEYOR POSITION		
	CURR_POS(PULSE)	CURR_POS
CV#01	393	3.930 mm
CV#02	0	0.000 mm
CV#03	0	0.000 mm

3. Move the conveyor for 1 m and more to the conveyor moving direction and stop.
 - The conveyor moving amount at this moment is referred as L (m).
4. Take note of the conveyor current value (pulses) at this moment as C2 (pulses).



CONVEYOR POSITION		
	CURR_POS(PULSE)	CURR_POS
CV#01	1508	15.080 mm
CV#02	0	0.000 mm
CV#03	0	0.000 mm

5. The resolution can be obtained by the formula with the measured valued C1, C2 and L.

$$\text{Resolution} = \frac{L \times 1000000}{C2 - C1} \quad (\mu/\text{pulse})$$

Since the conveyor resolution influences largely the follow-up accuracy, set a value as accurate as possible.

DX100

- 4 Settings for Conveyor Condition File
 4.3 Setting Conveyor Positional Resolution

4.3.2 Verifying and Adjusting Conveyor Positional Resolution

After the setting has been completed, verify and adjust the conveyor positional resolution in the following operations.

Prepare a job as shown below. This job is to perform a synchronized operation at execution of TIMER at P3 (③ in the below figures) on a conveyor. For teaching methods, refer to "5 Teaching".

<Job Example>

```

0000 NOP
0001 MOVJ VJ=25.00
0002 MOVL V=300.0
0003 SYSTART CV#(1) ST=10.000
0004 SYMOVL V=200.0 CV#(1) CTP=100.000
0005 TIMER T=10.00
0006 SYMOVL V=200.0 CV#(1) CTP=100.000
0007 SYEND CV#(1)
0008 MOVJ VJ=25.00
0009 END
  
```

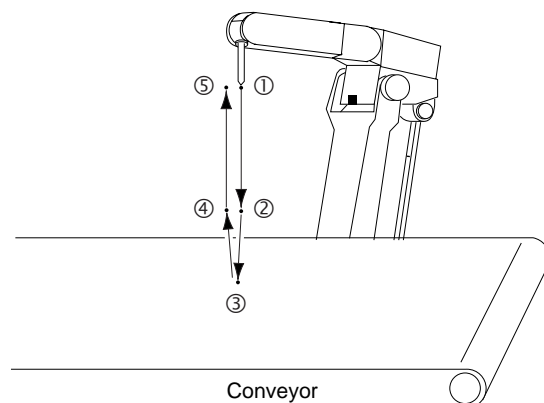

In the execution of this job, when the conveyor resolution value is correct, the tool center point of manipulator synchronizes the conveyor as shown in Fig. 3 and the manipulator moves as if its tool center point is fixed on the point ③.

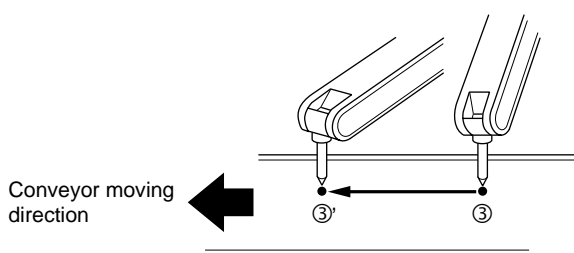

On the contrary, when the conveyor resolution value is not appropriate, the tool center point is dislocated farther from the point ③ as the follow-up time elapses as shown in Fig. 4-1 and Fig. 4-2, the conveyor resolution value is too big. In Fig. 4-2, the conveyor resolution value is too small.

According to the resulted follow-up error, adjust the positional resolution value in the conveyor condition file and re-set if necessary.

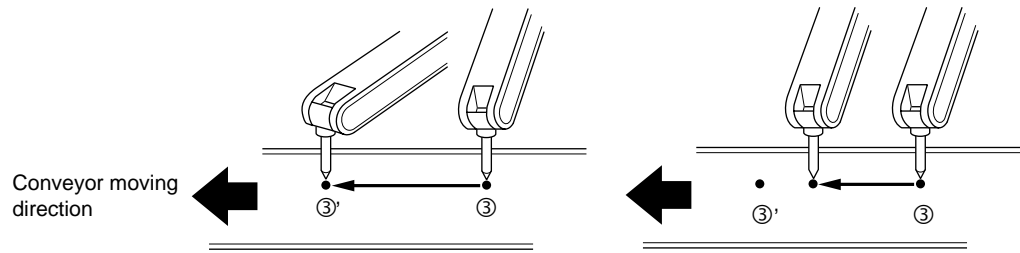

Fig. 4-3:

Fig. 4-4:

5 Teaching

5.1 Registering Instructions

The instructions can be registered when the cursor is in the address area on the job content window in teach mode.

1. Select {JOB} under the top menu.
2. Select {JOB CONTENT}.
3. Move the cursor to the address area.

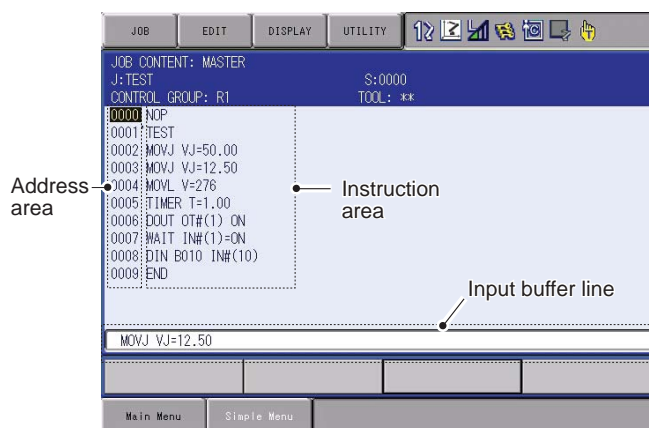

5.1.1 SYSTART Instruction

5.1.1.1 Function

This instruction indicates the start of a conveyor synchronized operation sequence. The manipulator starts follow-up motion by a move instruction after the SYSTART instruction, or TIMER or WAIT instruction.

When this instruction is executed, the manipulator stops and waits until the conveyor current position value exceeds the synchronization start position value. When it exceeds, the manipulator starts the synchronized motion.

After the instruction is executed, if the encoder reset signal is OFF and remains OFF for the time specified for "Reset signal monitoring" in the conveyor condition file, the execution of instruction is skipped and the succeeding instructions are executed. In this case, no synchronization takes place.

When the SYSTART instruction is executed, if the conveyor current position value already exceeds the synchronization start position value and the difference is within the tolerance (OL), the manipulator starts immediately from the current position the synchronized motion.

However, when the SYSTART instruction is executed, if the conveyor current position value already exceeds the synchronization start position value and the difference is greater than the tolerance (OL), execute the succeeding instructions without synchronized operation resetting the

system variable \$B008 to 0. The system variable \$B008 is 1 when the operation has been normally completed.

NOTE The system variable \$B008 can not be directly referenced. Copy to the variable Bxxx by GETS instruction and refer.

<Example>
 GETS B000 \$B0008
 JUMP *NG IF B000 <1
 |
 |
 |

5.1.1.2 Format

```
SYSTART CV#(1) STP=50.000 OL=10.0
           ①           ②           ③
```

- ① Conveyor Condition File No. (CONVEYOR FILE)
 Set the conveyor condition data file No. to be used.
- ② Synchronization Start Position (SYNC START POS)
 Set the conveyor position where the synchronized operation starts.
- ③ Tolerance (OVER LIMIT)
 Specify the maximum excess to execute the synchronized operation when the conveyor current position value exceeds the synchronization start position value at the execution of SYSTART instruction. Tolerance check will not be executed if setting is omitted or specified at 0.

5.1.1.3 Registering SYSTART Instruction

1. Move the cursor to the line just above the place where a SYSTART instruction is to be registered.
2. Press [INFORM LIST].
 - The instruction list dialog appears.



DX100

5 Teaching

5.1 Registering Instructions

3. Select "SYSTART".

- An instruction SYSTART is displayed in the input buffer line.



4. Change additional items.

<Register without editing additional items>

- Perform the operation in step 5.

<Edit the additional items>

To change the conveyor condition file No. or/and the synchronization start position

- Move the cursor to CONVEYOR FILE or SYNC START POS, and press [SELECT].
Enter a desired number or value by using the number keys, then press [ENTER].

To add, change or delete the additional item

- Move the cursor to CONVEYOR FILE or SYNC START POS, and press [SELECT].
Move the cursor to the instruction in the input buffer line, then press [SELECT]. The detail edit window appears.

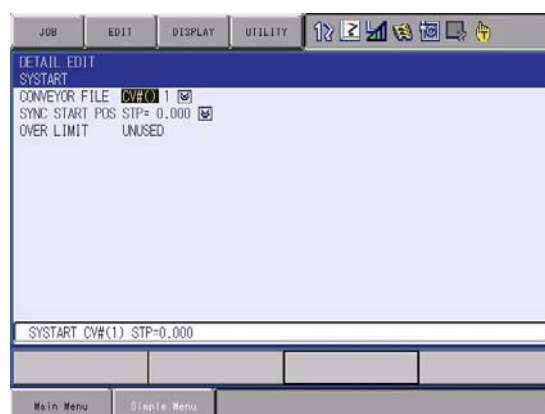

5 Teaching

5.1 Registering Instructions

- To add a tolerance, select “UNUSED” in OVER LIMIT. The selection dialog appears. Select “OL =”.

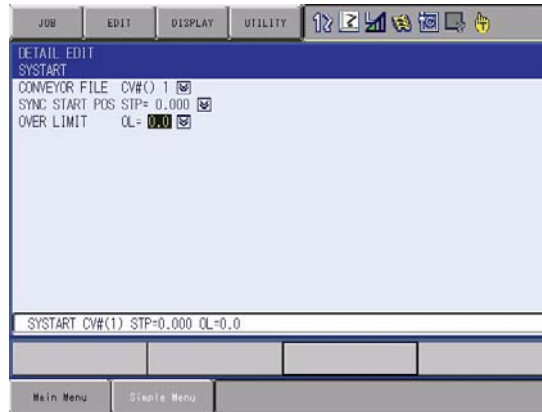

- After having added or changed the additional item, press [ENTER]. The detail edit window is closed and the job content window appears.
5. Press [INSERT] and [ENTER].
 - The instruction displayed in the input buffer line is registered.

5.1.2 SYEND Instruction

5.1.2.1 Function

This instruction indicates the end of a conveyor synchronized operation sequence. The synchronized operation ends at the step where this instruction is registered.

Executing the SYEND instruction clears the conveyor home-position registered status. Then, when the conveyor home-position limit switch is ON, the conveyor home-position is updated.

Register SYEND instruction at the synchronized operation sequence end step and the head of job where the synchronized motion is performed.

5.1.2.2 Format

SYEND CV#(1)

①

- ① Conveyor Condition File No. (CONVEYOR FILE)
Set the conveyor condition file No. to be used.

5.1.2.3 Registering SYEND Instruction

1. Move the cursor to the line just above the place where a SYEND instruction is to be registered.
2. Press [INFORM LIST].

5 Teaching

5.1 Registering Instructions

- The instruction list dialog appears.



3. Select "SYEND".

- An instruction SYEND is displayed in the input buffer line.



4. Press [INSERT] and [ENTER].

- The instruction displayed in the input buffer line is registered.

	5	Teaching
DX100	5.1	Registering Instructions

5.1.3 SYMOV□ Instruction

5.1.3.1 Function

These move instructions perform the conveyor synchronized motion. Except that the conveyor position at the time of teaching is registered as CTP (conveyor teaching position), these instructions are the same as ordinary move instructions. Joint motion, linear interpolation, and circular interpolation can be performed in the same way as the ordinary move instructions. However, SYMOVJ (joint motion for conveyor synchronized operation) can be used only when the base axis is selected for synchronization. If SYMOVJ is executed when the robot axis is used for synchronization, the alarm 4583 "CAN NOT USE SMOVJ DURING TRACKING" occurs and the manipulator stops.

SYMOVJ	Joint motion for conveyor synchronized operation (can be used only for synchronization by base axis).
SYMOVL	Liner interpolation for conveyor synchronized operation
SYMOVC	Circular interpolation for conveyor synchronized operation

When these instructions are used, the teaching method is different from that with the ordinary move instructions. Refer to 5.1.4 "Interpolation Mode for Conveyor Synchronized Operation".

5.1.3.2 Format

SYMOVJ VJ=50.00 CV#(1) CTP=100.000

SYMOVL V=200.0 CV#(1) CTP=100.000

SYMOVC V=200.0 CV#(1) CTP=100.000

① ② ③

① Play speed

Set the motion speed at playback.

② Conveyor condition file No.

Set the conveyor condition data file No. to be used.

③ Conveyor position at teaching

Set the conveyor position for teaching.

DX100	5 Teaching
	5.1 Registering Instructions

5.1.4 Interpolation Mode for Conveyor Synchronized Operation

The interpolation mode of move instructions for conveyor synchronized operation differs from that of ordinary move instructions. Therefore, teaching is performed in “interpolation mode for conveyor synchronized operation”. Switch the interpolation mode in the following manner.

Since the conveyor positions at teaching is registered, they must be properly set up in relation to the conveyor home-position (the position where the conveyor home-position limit switch is ON).

5.1.4.1 Switching the Interpolation Mode

Pressing [SHIFT] + [MOTION TYPE] switches the interpolation mode in the input buffer line between conveyor synchronized interpolation and standard interpolation.

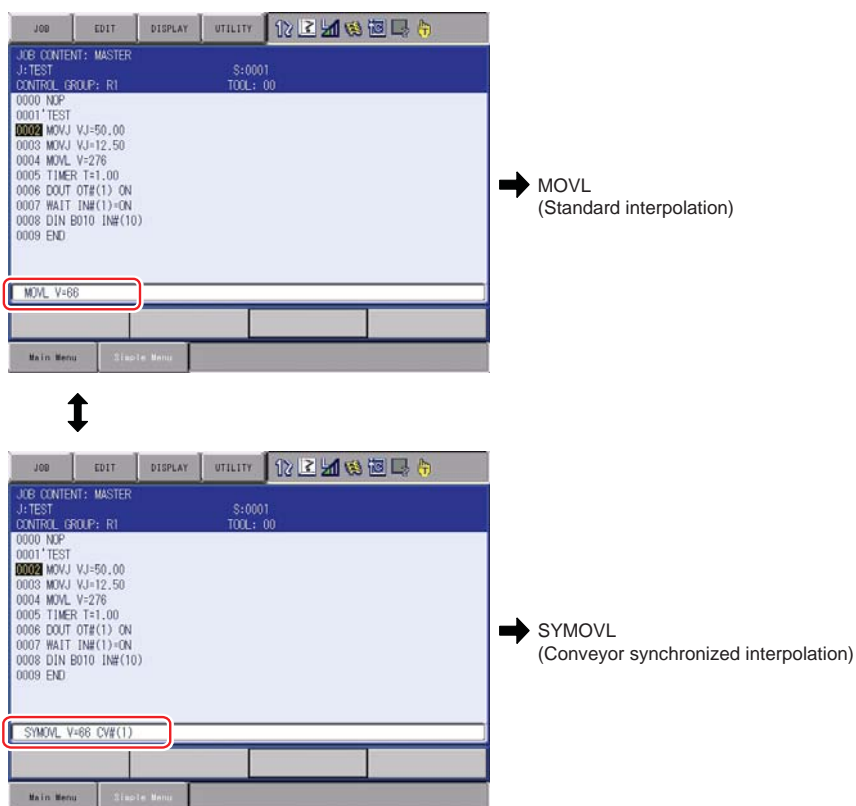

Press [MOTION TYPE].

The interpolation mode switches as: SYMOVJ→SYMOVL→SYMOV C.

5.2 Motion Speed

Generally, teaching in the direction opposite to the conveyor moving direction gives such a result as a manipulator can move more easily and slowly in playback operation.

In the conveyor synchronized operation, the manipulator motion speed is the teaching speed added the conveyor motion speed.

However, depending on the relation between the direction of manipulator motion and the conveyor moving direction, the speed is added in the different way as shown below.

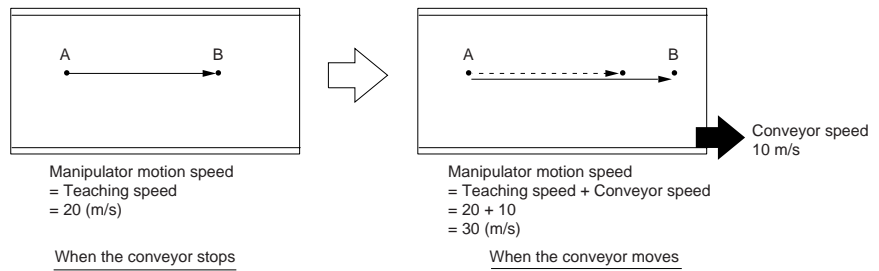

Fig. 5-5: When Teaching Direction is the Same as the Conveyor Moving Direction

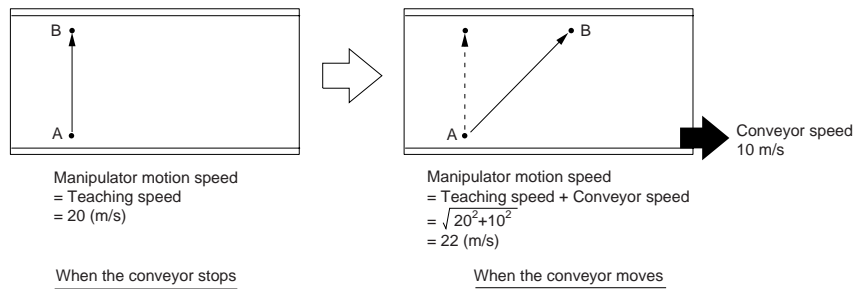

Fig. 5-6: When Teaching Direction is Different from Conveyor Moving Direction by 90°

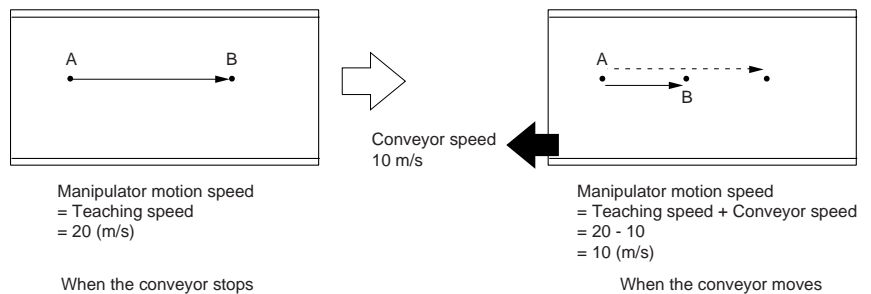

Fig. 5-7: When Teaching Direction is Opposite to Conveyor Moving Direction

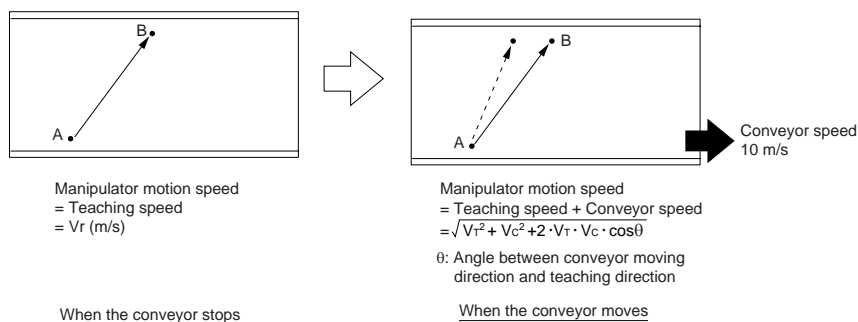

Fig. 5-8: Relation among Manipulator Motion Speed, Teaching Speed, and Conveyor Speed

As shown in Fig. 8, the manipulator motion speed when the conveyor moves is slower than that when the conveyor stops even though the teaching speed remains same. On the contrary, in case of Fig. 6, the manipulator motion speed when the conveyor moves is faster than that when the conveyor stops.

Therefore, teaching in the direction opposite to the conveyor moving direction is more useful for manipulator.

5.3 Wrist Posture in Synchronization

In the synchronization section, the wrist maintains its taught posture while the manipulator is synchronizing the conveyor. Teach a posture so that the wrist can be moved in the conveyor moving direction.

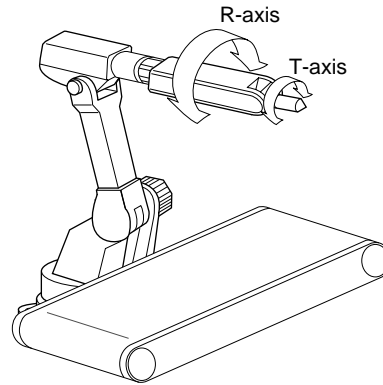

Fig. 5-9: Wrist Posture Not Recommended

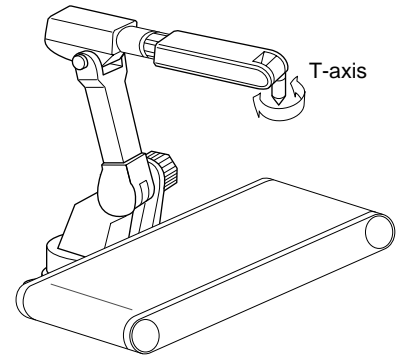
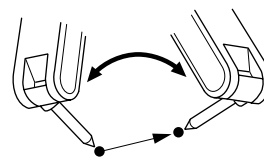

Fig. 5-10: Wrist Posture Recommended

For example, if the wrist is taught the posture as shown in Fig. 10, the structure of the manipulator prevents T-axis control in the conveyor moving direction. Trying to compensate this, R-axis turns sharply, possibly leading to an alarm such as segment over during the synchronized operation, which stops the manipulator.

On the contrary, if the wrist is postured as shown in Fig. 11 in teaching, T-axis can turn to adapt to position changes in the conveyor moving direction. In this case, sufficient clearance must be provided around the wrist to allow T-axis to turn for position control.

To check whether the wrist posture is appropriate, move the user coordinate X-axis in the conveyor moving direction with the wrist held in the taught posture to confirm that any axis does not move sharply.



With a move instruction for conveyor synchronized operation, when teaching is performed so that the posture changes largely in short distance, a segment over alarm may occur. To avoid such an alarm, take the following method.

- Set the speed not as “V = …(Tool center point speed)” but as “VR = … (Posture angle speed)”
- Lower the speed of “V = …”

5.4 Circular Interpolation Steps

Continuous circular interpolation steps should be performed on the same conveyor position.

When continuous circular interpolation steps are taught on different conveyor positions, a path different from the taught path may be resulted in the synchronized operation.

5.5 Teaching

Since the conveyor positions at teaching are registered in a job, they must be properly set up in relation to the conveyor home-position (the position where the conveyor home-position limit switch is ON).

When teaching with a workpiece, move the conveyor and turn ON the conveyor home-position limit switch by the workpiece, then move to a teaching position. When the conveyor home-position limit switch is turned ON, the position where the switch is turned ON is registered automatically as the conveyor home-position.

①

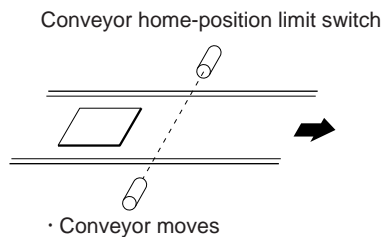
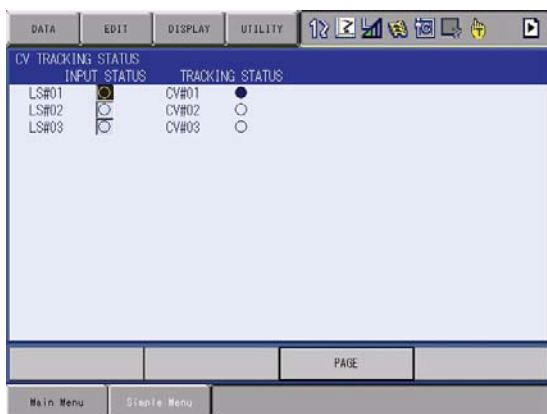

②

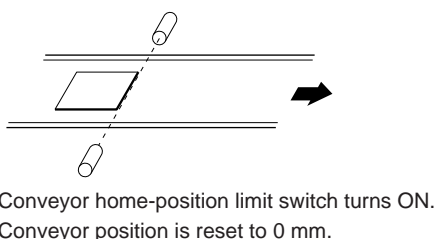
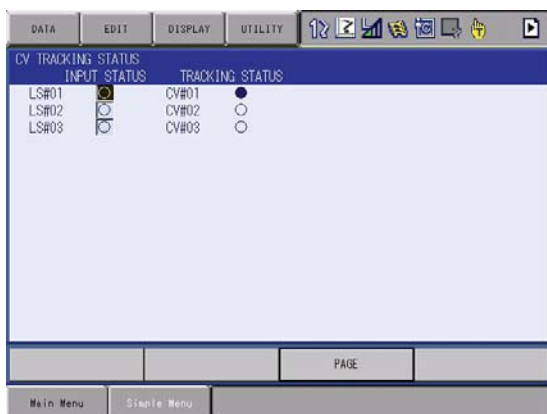

③

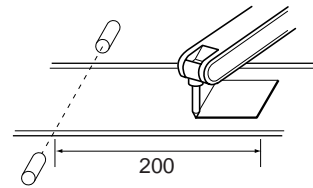
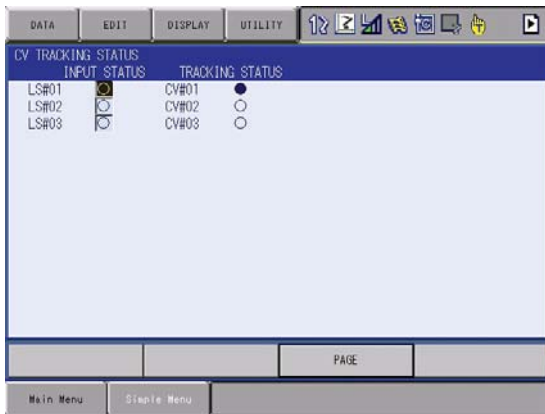

• Confirm by FWD operation, and add or change the step.

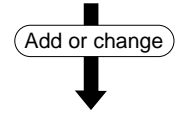

SYMOVL V=1000 CV#(1) CTP=200.000

NOTE Perform teaching after having confirmed that the conveyor is completely stopped. Teaching while the conveyor moves may cause an error or segment over alarm.

1. Select {ROBOT} under the top menu.
 2. Select {CV MONITOR}.
- The CONVEYOR POSITION window appears.



DX100

- 5 Teaching
- 5.5 Teaching

3. Move the conveyor.

- Move the conveyor, and after the conveyor home-position limit switch is ON, stop the workpiece at the teaching position.
At the moment the conveyor home-position limit switch is ON, “CURR POS (PULSE)” in the conveyor position window is reset to “0”, which confirms that the counter is reset.



4. Display JOB CONTENT window
5. Press [SHIFT] + [MOTION TYPE].
 - The motion type is set to the conveyor synchronized interpolation mode.
6. Select a motion type
 - Select a motion type to be used by pressing [MOTION TYPE].
7. Press an axis key.
 - Move the manipulator to a desired position by using axis keys.
8. Press [ENTER].
 - The step is registered.

<Example>

When teaching is performed at the position 1000 mm from the conveyor home-position in linear interpolation, using the conveyor condition file No. 1, it will be registered as follows.

```
0005 SYMOVL V=100.0 CV#(1) CTP=1000.000
```

The registration after the above is the same as that for an ordinary teaching.

When a move instruction for conveyor synchronized operation is used again after the motion type mode is changed to other than conveyor synchronized interpolation mode in a teaching for air-cut and so on, the conveyor synchronized interpolation mode must be re-selected.

5.6 Teaching After Interruption of Playback in Synchronized Operation

When the synchronized operation is interrupted by hold operation or switching to teach mode and so on during playback in synchronized operation, if another conveyor home-position is attempted to be registered, a conveyor home-position input signal is not accepted. At this moment, the tracking status in the conveyor tracking window is "ON" (marked with ●).

The operations in the following two cases are explained:

- When adding or changing step after interruption of synchronized operation.
- When performing another teaching (for other workpiece).

5.6.1 When Adding or Changing Step After Interruption of Synchronized Operation

In the state that the synchronized operation in play mode is interrupted, a step can be added or changed. Confirm the step position by FWD operation, then add or change.

①

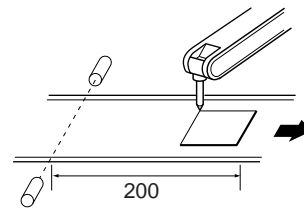
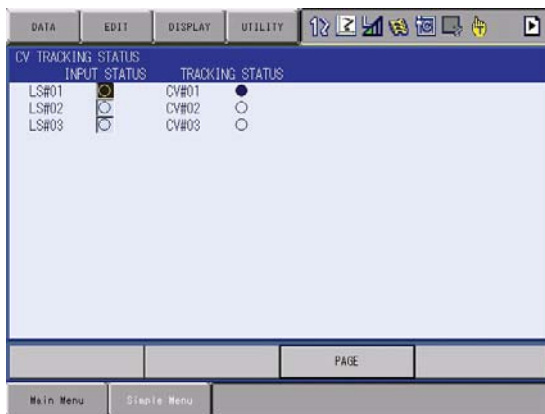

• During conveyor synchronized operation in play mode

②

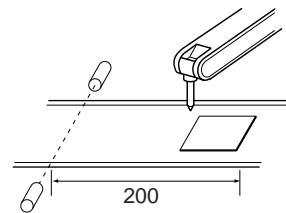
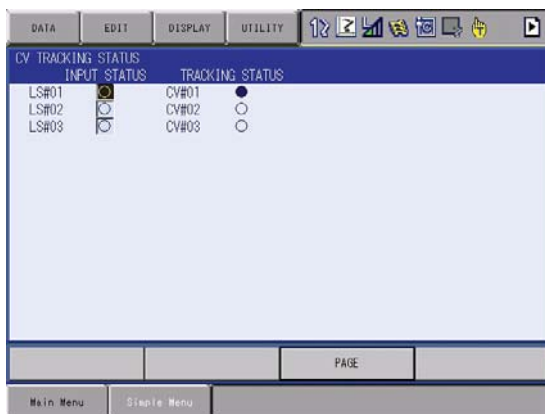

• Synchronized operation interrupted (Switched to teach mode. Manipulator stops; the conveyor also stops.)

③

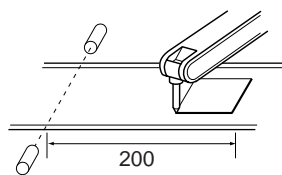

· Confirm by FWD operation, and add or change the step.

Add or change

SYMOVL V=1000 CV#(1) CTP=200.000

5.6.2 When Performing Another Teaching (for Other Workpiece)

1. Reset the synchronized operation status by executing an instruction SYEND or shutting down the control power supply.

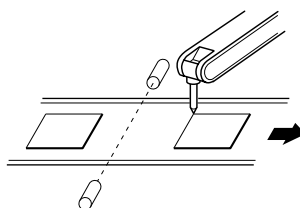
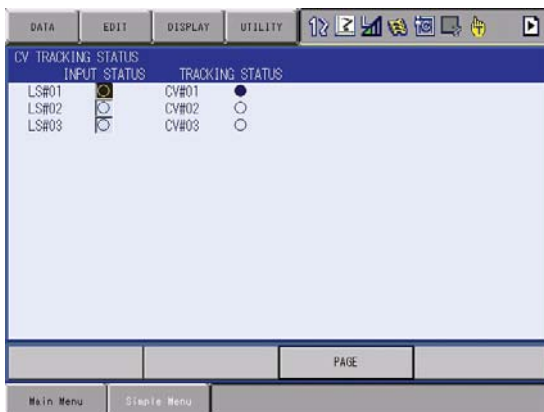

· Conveyor synchronized operation interrupted.
(Switched to teach mode.
(Manipulator stops; the conveyor) also stops.)

5 Teaching

5.6 Teaching After Interruption of Playback in Synchronized Operation

2. Confirm that TRACKING STATUS in the conveyor tracking status window is OFF (marked with O).

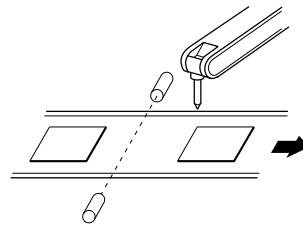
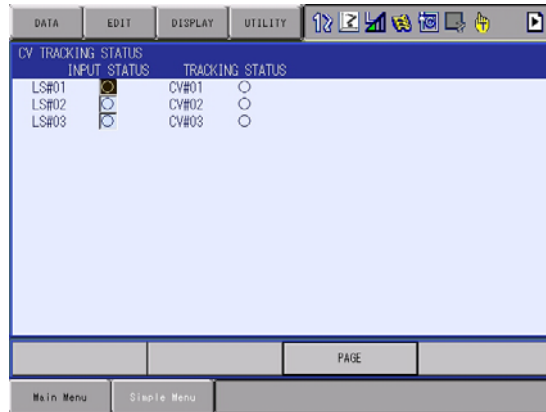

· Execute SYEND instruction.

3. Move the conveyor, and turn ON the conveyor home-position limit switch by the workpiece.
4. Move the manipulator to the teaching point and teach.

5.7 Notes on Operation

The conveyor synchronized move instructions are special instructions for registering a conveyor position together with a manipulator position. Therefore, different from ordinary move instructions such as MOVJ, these instructions have the following restrictions on operations.

5.7.1 Confirming Reach to Step

When the manipulator reaches the target step in FWD/BWD operation or test run (step motion mode) by a conveyor synchronized move instruction, the operation is stopped and the cursor stops blinking. In this way, it can be easily confirmed that the manipulator reaches the target step.

NOTE

When the manipulator reaches the target step, the cursor stops blinking, however, the cursor restarts blinking when the following operations are performed. In this case, move the cursor to the target step and perform FWD operation again.

- Emergency stop
- The cursor is moved in editing job
- File and job editing operation
- Jog operation

5.7.2 Backward (BWD) Operation

Releasing [FWD] and pressing [BWD] in middle of FWD operation does not return the manipulator to the previous step, but the manipulator continues the FWD operation to the next step. Pressing [BWD] after the manipulator reaches the next step, returns the manipulator to the previous step.

5.7.3 Changing Tool

The FWD operation of the first SYMOV□ instruction after changing a tool, should be performed on the conveyor position at changing a tool.

Performing the FWD operation after changing a tool and moving the conveyor causes a segment over alarm.

5.7.4 Deleting Taught Points

Before deleting a move instruction, the manipulator must be placed at the step position to be deleted. However, this condition can not be satisfied with conveyor synchronized move instructions. This is because a taught position for a conveyor synchronized move instruction is interpreted to different step positions on the conveyor position, as explained before. Therefore, ordinary deleting operation is not possible.

To delete a conveyor synchronized move instruction, press [MODIFY] to change the step position. Then, after the cursor blinks, press [DELETE].

	5	Teaching
DX100	5.8	Job Example

5.8 Job Example

A basic job example is shown below.

Instruction	Explanation
NOP	
SYEND CV#(1)	Resets the conveyor home-position registered status. After then, a conveyor home-position limit switch signal is accepted.
MOVJ	After the job is started, the manipulator moves to its stand-by position.
SYSTART CV#(1) STP=100.000	Conveyor synchronization start instruction If the conveyor reaches the specified position (ex.: 100 mm), the conveyor synchronization starts.
GETS B000 \$B008	Converts system variable \$B008, which indicated whether the synchronized operation starts normally or not, to B000. Normal if B000 = 1, abnormal if B000 = 0.
JUMP *END IF B000=0	If B000 is 0 (synchronized operation could not start due to an error), jump to the label "**END".
SYMOVL CV#(1) CTP=50.000 SYMOVL CV#(1) CTP=50.000	Conveyor synchronized move instruction Moves in conveyor synchronized status.
*END	Jump destination in case of failure in normal starting of conveyor synchronized operation
SYEND CV#(1)	Ends the conveyor synchronized operation.
MOVJ END	The manipulator returns to the stand-by position. End.

DX100

6 Playback
6.1 Conveyor Speed Down

6 Playback

6.1 Conveyor Speed Down

When the conveyor slows down while the manipulator is synchronizing the conveyor, the manipulator will react according to the mode setting in the conveyor condition data file:



Conveyor Condition File Window

- EXECUTE

Regardless of the conveyor speed, the manipulator continues its operation.

- ALARM

An alarm occurs when the conveyor speed slows down.

- PAUSE JOB

The manipulator stops the job operation but only continues follow-up motion when the conveyor speed slows down.

For details of these three modes, refer to “¹⁵ CONVEYOR SPEED DOWN MODE (EXECUTE/ALARM/PAUSE JOB)” explained in “4.1 Conveyor Condition File”.

6.2 Accuracy

The conveyor synchronized operation function reproduces the path taught with the conveyor in stop status.

Therefore, the accuracy of conveyor synchronized operation function is determined by the amount of difference between the taught path and the synchronized path. Since the object is moving, it is impossible to appreciate the accuracy in the same way as the repetitive positioning accuracy for the still-object.

The amount of difference between the taught path and the synchronized path is resulted from the following factors in interaction. Even if the following factors are adjusted not to cause the difference, the difference shows about ten times the difference from repetitive positioning for still-object.

- Linearity of the conveyor in the synchronization section.
- Conveyor movements that are not indicated in motion pulse data from a conveyor encoder (such as swings with a hanger conveyor).
- Differences between the manipulator actual dimensions and the dimensions registered in DX100.
- Conversion resolution error that occurs when converting the conveyor motion pulse (number of pulses) from the conveyor encoder to the conveyor moving amount (mm). The details of conversion resolution error will be explained in "6.3 Conveyor Resolution Error".
- Manipulator mechanical accuracy such as arm bending.
- Follow-up delay for the conveyor speed fluctuation.
- Manipulator system lag time.
- Difference between the conveyor moving direction and the traveling axis moving direction when the synchronization is performed by the traveling axis.

6.3 Conveyor Resolution Error

The synchronization error resulted from the conveyor resolution setting error increases as the conveyor position value increases. The farther the conveyor moves, the bigger the synchronization error becomes. The minimum value for conveyor positional resolution setting is 0.01 μm . Therefore, a maximum error of 0.005 μm per pulse may occur.

For example, when the conveyor resolution is 10 μm and the synchronization distance is 2 m, 200000 pulses are output while the conveyor moves for 2 m. Since the maximum error per pulse is 0.005 μm , the synchronization error would be: 200000 pulses * 0.005 μm = 1 mm.

6.4 Restarting Synchronization After Manipulator Stops

When a manipulator stops during the conveyor synchronized operation in the following cases, the synchronized operation is restarted by restarting the manipulator:

- Minor failure alarm (excluding occurrence of alarm related to the conveyor synchronized function)
- Emergency stop or external emergency stop
- Hold or external hold
- Switch of the mode (mode switching between play and teach mode)
- Switch of the operation cycle (switching among auto/ 1 cycle/ step)

6.5 Continuance of Conveyor Synchronized Status

The conveyor synchronized status started by execution of SYSTART instruction remains until SYEND instruction is executed or the control power supply is turned OFF. Even if a manipulator stops in the cases explained in the previous section, the conveyor synchronized status remains.

Note that the synchronized operation is performed by execution of SYMOV□ instruction even if the cursor is moved in teach mode, the master job is called or a job selection is made.

6.6 Continuance of Parallel Shift Status

The parallel shift status in the conveyor synchronized status continues even after a manipulator stops in the cases explained in the previous section. However, the parallel shift status is cleared in the following cases. Be careful when using the parallel shift function in combination with the conveyor synchronized function.

- Execution of SFTOF instruction
- The cursor is moved in teach mode
- The master job is called
- Job selection
- The main power supply is shut down.

6.7 Conveyor Synchronized Operation During Execution of TIMER and WAIT

While the manipulator is in waiting status by execution of TIMER, WAIT, and so forth, the conveyor synchronized operation continues.

7 Conveyor Monitoring Windows

There are three windows for conveyor monitoring as follows:

- Conveyor position window.
- Conveyor speed window.
- Conveyor tracking status window.

Call each window in the following manner.

1. Select {ROBOT} under the top menu.
2. Select {CV MONITOR}.
3. Display the conveyor position window.
4. Display a desired window.

– Page key  switches from one window to another in the following order:

CONVEYOR POSITION window → CONVEYOR SPEED window → CV TRACKING STATUS window.

Press [SHIFT] + the page key  to return to the previous window.

7.1 Conveyor Position Window

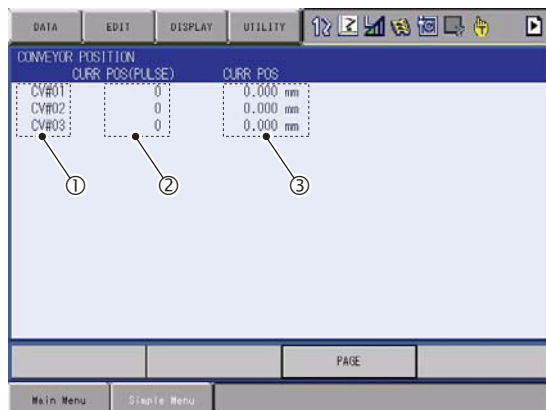

① Conveyor Condition File No.

With one conveyor board, CV#1 to CV#3 are displayed. With two conveyor boards, CV#1 to CV#6 are displayed.

② CURR POS (PULSE)

The number of feedback pulses from the encoder connected to the conveyor calculated on the base of the position where the conveyor home-position limit switch turns ON as "0". Used for setting of conveyor resolution.

③ CURR POS (mm)

The value converted from the number of pulses of current position into the distance from the position where the conveyor home-position limit switch turns ON by using the resolution. When the resolution is not set, "0" is displayed.

7.2 Conveyor Speed Window

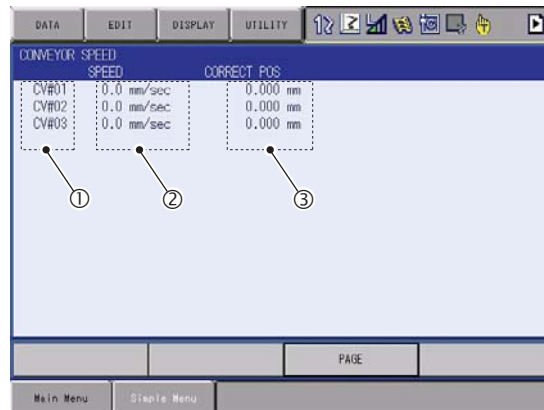

① Conveyor Condition File No.

With one conveyor board, CV#1 to CV#3 are displayed. With two conveyor boards, CV#1 to CV#6 are displayed.

② SPEED (mm/sec)

Conveyor averaged speed per 0.1 sec.

③ CORRECT POS (mm)

The manipulator follows up the conveyor with a certain delay time to the input conveyor position. Therefore, performing the follow-up motion according to the conveyor current position causes a follow-up error. With the DX100, the follow-up motion is performed according to the conveyor position compensated for the follow-up error. This compensated conveyor position is displayed here.

7.3 Conveyor Tracking Status Window

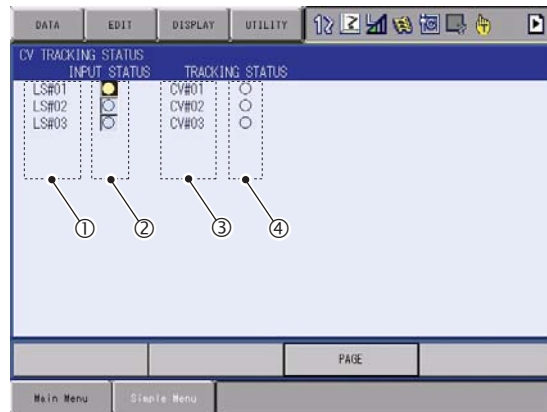

① Conveyor Home-Position Input Signal No.

The conveyor home-position input signal Nos. LS#1, LS#2, and LS#3 are the input signals connected to CN1, CN2, and CN3 respectively. LS#4, LS#5, and LS#6 are the input signals connected to CN1, CN2, and CN3 of the 2nd conveyor board respectively.

② INPUT STATUS

Indicates each conveyor home-position input status.

●: Indicated when the manipulator is not synchronizing the conveyor and the conveyor home-position input signal turns ON.

○: Indicated when the conveyor home-position input signal turns OFF.

③ Conveyor Condition File No.

With one conveyor board, CV#1 to CV#3 are displayed. With two conveyor boards, CV#1 to CV#6 are displayed.

④ TRACKING STATUS

Indicates the manipulator synchronizing status.

●: Indicated when the manipulator is in synchronized operation status after the synchronized operation starts by execution of SYSTART instruction or after SYMOV□ instruction is executed in FWD operation.

As long as “●” is indicated, the conveyor home-position input signal is not accepted and the synchronized status remains until the execution of SYEND instruction or the control power supply is shut down.

○: Indicated when the manipulator synchronizing status is cancelled.

	8	Virtual Encoder Mode
DX100	8.1	Virtual Encoder Pulse Count

8 Virtual Encoder Mode

8.1 Virtual Encoder Pulse Count

When the manipulator is stopped during operation with a virtual encoder, the virtual encoder pulse counting is stopped as well as the manipulator. Since the virtual encoder continues counting pulses by restarting the manipulator, the manipulator can be restarted from the position where it stopped.

8.2 Relation Between Encoder Input and Virtual Encoder Input

There are two types of settings for encoder input:

- Setting by “ENCORDER INPUT” in the conveyor condition file.
- Setting by “VIRTUAL ENCORDER INPUT” in the conveyor condition file.

The relation between “ENCORDER INPUT” setting and the virtual encoder by “general purpose input signal” setting is as follows:

- When the “ENCORDER INPUT” = “VIRTUAL ENCDR”
Regardless of the status of general purpose input signal, the manipulator operates with the virtual encoder pulse.
- When the “ENCORDER INPUT” = “ENCORDER”
When the general input signal is ON, the manipulator operates with the virtual encoder pulse.
When the general input signal is OFF, the manipulator operates with the encoder input.

8.3 Precaution on Switching the Encoder Mode

Switching the mode “Encoder/Virtual Encoder” by the general purpose input signal during the conveyor synchronized operation causes the alarm “CANNOT CHANGE CONVEYOR MODE”.

Be sure to switch the encoder mode by the general purpose input signal while the manipulator is not in the conveyor synchronized operation.

9 Turntable Synchronized Function

Functional Overview

This function enables interpolation motion of the manipulator, synchronized with circular conveyor and turntable.

9.1 Setting Up the Turntable Synchronized System

9.1.1 Settings for Conveyor Condition File

To use this function, set the TRACKING (①) in CONVEYOR COND FILE window to "CIRCULAR". (Use a cursor key to scroll the window.)

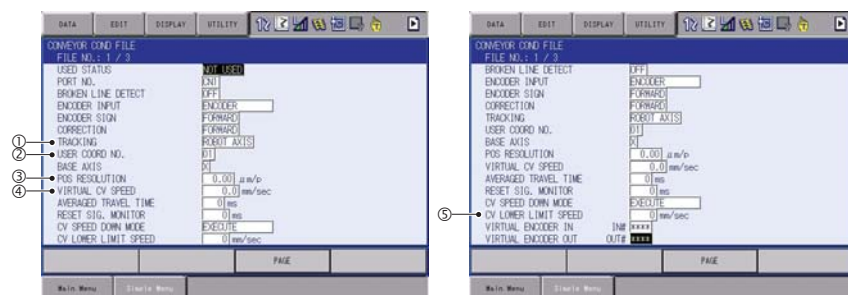

- ① TRACKING (ROBOT-AXIS/BASE-AXIS/CIRCULAR)
CIRCULAR: specify CIRCULAR for turntable synchronized function. If CIRCULAR is specified, the manipulator performs a circular tracking operation in accordance with a result of calibration executed in 9.1.2.
- ② USER COORD NO. (1 to 24)
Specify the user coordinate number to store the result of calibration (relative position of the turntable).
- ③ POS RESOLUTION (1 to 2147483647 pulse/rev)
Set a pulse count from encoder per turntable revolution. If the turntable positional resolution is unknown, use the data calculated in the calibration.
- ④ VIRTUAL CV SPEED (-32767 to +32767 pulse/sec)
- ⑤ CV LOWER LIMIT SPEED (0 to 65535 pulse/sec)
Input unit changes to "mm/sec" to "p/sec" by setting the tracking method (item ①) to CIRCULAR.

9.1.2 Calibration between Manipulator and Turntable

The manipulator-turntable calibration is a setting required before carrying out a synchronized operation of manipulator and turntable. Before the synchronized operation, register their positional correlation following the procedures explained in this section.

9.1.2.1 Setting a Calibration Tool

1. Equip the manipulator with a calibration tool.
 - Use a tool of which accurate dimensions are given.

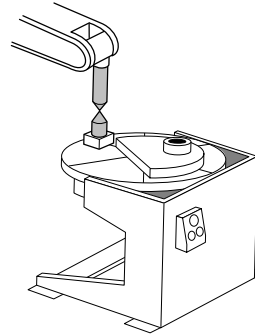

2. Select {ROBOT} under the top menu.
3. Select {TOOL}.
 - The TOOL window appears.

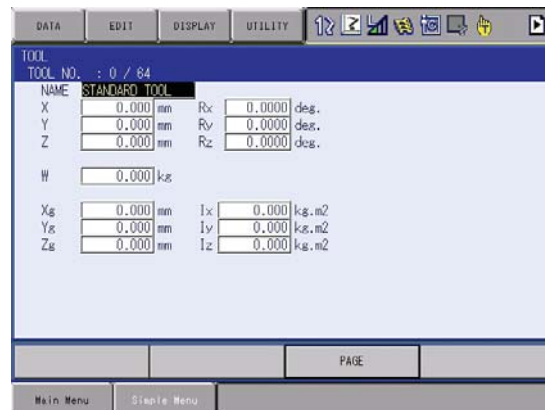

4. Input the tool measurement.
5. Press [ENTER].

9.1.2.2 Teaching Calibration Position

1. Define a desired point (P-point) on turntable.
Adjust the manipulator control point to the P-point, and register C1.

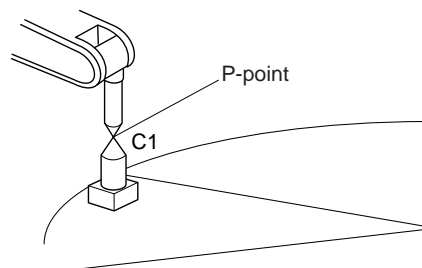

2. Rotate the turntable to desirable extent. (Make sure to rotate it in direction of normal rotation.)
Adjust the manipulator control point to the rotated P-point, and register C2.

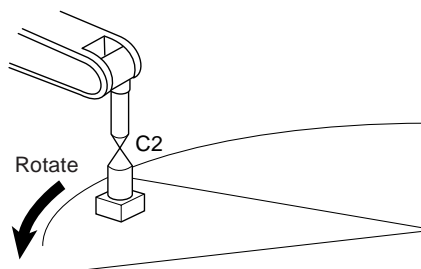

3. Rotate the turntable in the same direction as the previous step.
Adjust the manipulator control point to the rotated P-point, and register C3.

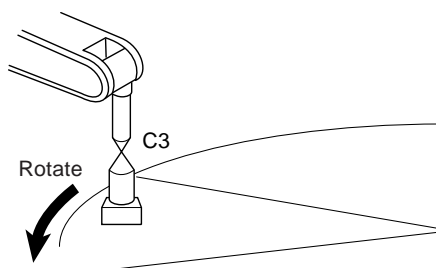

9.1.2.3 Operating Calibration

1. Select {ROBOT} under the top menu.
2. Select {CONVEYOR CALIBRATION}.

9 Turntable Synchronized Function
 9.1 Setting Up the Turntable Synchronized System

– The CONVEYOR CALIBRATION window appears.

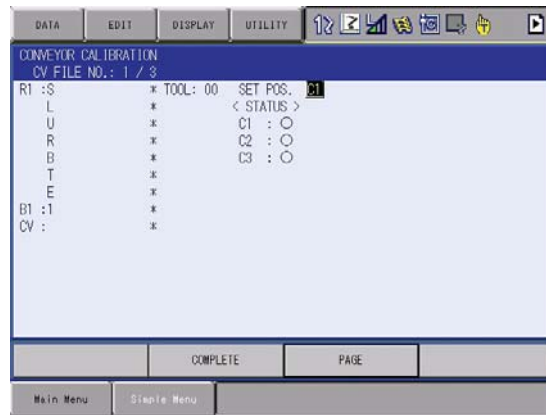

- Click on {PAGE} to select a desired conveyor condition file. Press [ENTER] after deciding the file number.

(Note that this process can be achieved by pressing  key.)

- Move the cursor to “**“ to select a manipulator.
 (Note that the asterisk indicates that there is more than one manipulator: skip this process if there is only one manipulator to control.)

– Select a manipulator from a drop-down listbox.

- Select {SET POS}.
- Turn ON the home position limit switch by moving the turntable.
- Move the manipulator to the calibration position with axis keys.
- Press [MODIFY], then [ENTER].

– The taught position will be displayed on the window.

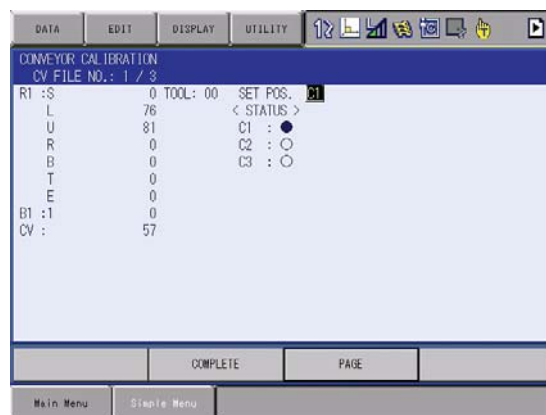

DX100

9 Turntable Synchronized Function

9.1 Setting Up the Turntable Synchronized System

9. Select {COMPLETE}.
 - The calibration position is registered.
 - The taught coordinates are registered in the user coordinate number which is specified in the conveyor condition file. The registered data can be modified by inputting numbers.

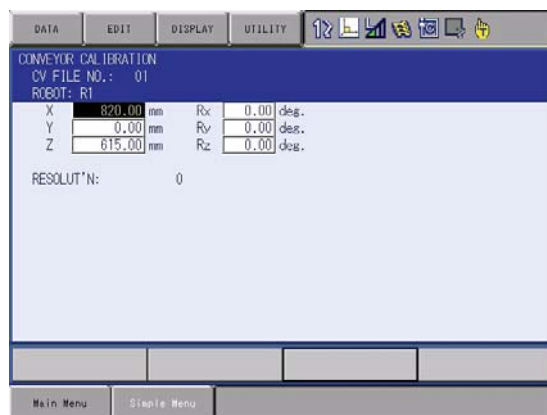

- The turntable positional resolution will be calculated when the calibration is carried out.
- If the turntable positional resolution has not been given, set the calculated resolution in the conveyor condition file.

9.2 Modifying Instructions

In case of using the turntable synchronized function, the units used for distance and speed are changed from mm (μ) to pulse. The instructions are modified accordingly as follows:

- SYSTART Instruction

[Linear Conveyor Synchronization]

SYSTART CV (#1) STP=50.000 OL=10.0

[Turntable Synchronization]

SYSTART CV (#1) STPP=5000 OLP=100
① ②

① Synchronization start position in pulse

Set the conveyor position where the synchronized operation starts in pulse.

② Tolerance

Specify the maximum excess in pulse to execute the synchronized operation when the conveyor current position value exceeds the synchronization start position value at the execution of SYSTART instruction. Tolerance check will not be executed if setting is omitted or specified at 0.

- SYMOV□ Instruction

[Linear Conveyor Synchronization]

SYMOVL V=200.0CV (#1) CTP=100.000

SYMOVC V=200.0CV (#1) CTP=100.000

[Turntable Synchronization]

SYMOVL V=200.0CV (#1) CTPP=100.000

SYMOVL V=200.0CV (#1) CTPP=100.000
①

① Conveyor position at teaching

Set the conveyor position for teaching in pulse.

10 Manual Conveyor Function

Manual Conveyor Function is a manual setting function for conveyor position. This function enables the conveyor position to be set from the programming pendant without moving the conveyor to modify the taught job.

With this function, instead of moving the conveyor to move the workpiece to the teaching position, by removing a fastening device such as a dog and moving the workpiece to the desired position on the conveyor, the conveyor position can be input to modify the taught job. When the taught job is modified by using the Manual Conveyor Function, the newly set value of the conveyor position is registered to the value of CTP when the registration of the move instruction for the synchronized motion (SYMOV□) is modified.

1. Select {ROBOT} under the top menu.
2. Select {MANUAL CONVEYOR}.
- The MANUAL CONVEYOR window appears.

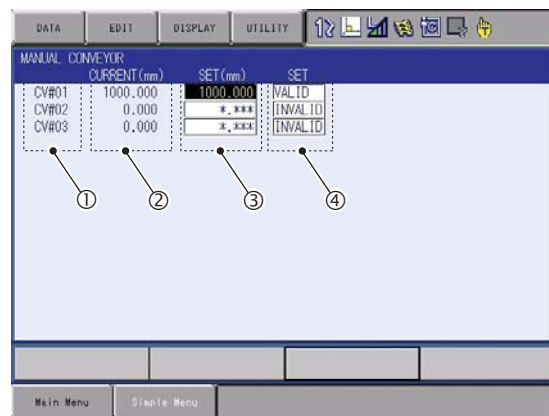

- ① Conveyor Condition File No.
Displays CV#1 to 3 when one conveyor board is mounted, and CV#1 to 6 when two conveyor boards are mounted.
- ② CURRENT (mm)
Indicates the conveyor's current position (in actual amount of pulses). When the Manual Conveyor Function is used, the position data set is displayed.
- ③ SET (mm) (0 to 21000 mm)
Sets the conveyor position. A value out of the setting range cannot be entered.
- ④ SET
Enables or disables the manual setting mode for the conveyor position.

	10	Manual Conveyor Function
DX100	10.1	Settings for Manual Conveyor Function

10.1 Settings for Manual Conveyor Function

10.1.1 Setting the Conveyor Position

1. Move the cursor to the desired value in the column of the {SET (mm)}.
2. Enter a value using the numeric keys.

10.1.2 Enabling/Disabling the Setting

1. Move the cursor to the desired value in the column of the {SET}.
2. Press [SELECT].
 - “VALID” and “INVALID” switch alternately.

10.2 Precautions

10.2.1 When the Power is Turned ON

When the power is turned ON, all the setting for the Manual Conveyor Function are disabled regardless of the play or teach mode, and the actual conveyor positions are indicated in {CURRENT (mm)}.

When the MANUAL CONVEYOR window is called up after the power is turned ON, “***” appears in the column of {SET (mm)}. The set conveyor positions are retained until the power is turned OFF.



- When the teach mode is switched to the play mode while the Manual Conveyor Function is enabled, the function is automatically disabled.
- The MANUAL CONVEYOR window can be viewed only in the teach mode.
- The Manual Conveyor Function is enabled only when the turntable synchronized function is disabled.

11 Manual Setting Function for Conveyor Home-Position Limit Switch

When the conveyor home-position limit switch cannot be turned ON, it can be pseudonymously turned ON in the following manner:

1. Open the CV TRACKING STATUS window.

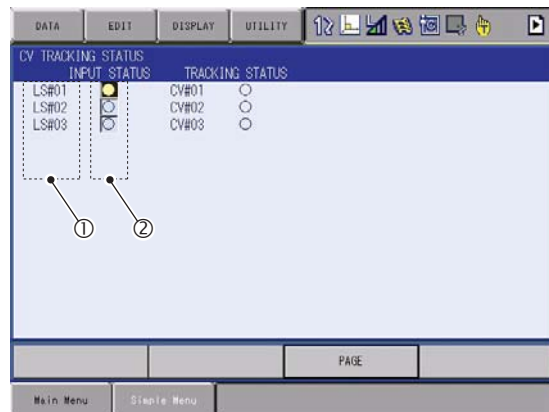

① LS#

Indicates the conveyor home-position input signal number.

② INPUT STATUS

Indicates the conveyor home-position input signal status, or inputs the conveyor home-position input signal.

2. Move the cursor to the limit switch number connected to the conveyor home-position input signal that is set in PORT NO. in the conveyor condition file.
3. By pressing [INTERLOCK] and [SELECT] at the same time, select "ON" status to pseudonymously turn the conveyor home-position input signal ON.

The manual setting function for pseudo ON of the conveyor home-position limit switch is valid only in the teach mode. This function is disabled in the play mode.

12 Instruction List

"< >" indicates numerical or alphabetical data. If one or more items are shown in one section, select one of them.

SYSTART	Function	Starts the conveyor synchronized operation.	
	Instruction items	CV# (<Conveyor condition file No.>)	1 to 6
		STP= <Synchronization start position (mm)>	
		OL= <Tolerance (mm)>	When omitted or 0 is set, the tolerance check is not performed.
Example	SYSTART CV#(1) STP=100.000		
SYMOVJ ^{*1}	Function	Moves in joint motion in synchronization with the conveyor.	
	Instruction items	CV# (<Conveyor condition file No.>)	1 to 6
		CTP= <Conveyor position at teaching (mm)>	
		VJ= <Play speed (%)>	VJ: 0.01 to 100.00
Example	SYMOVJ VJ=50.00 CV#(1) CTP=100.000		
SYMOVL	Function	Moves in linear interpolation in synchronization with the conveyor.	
	Instruction items	CV# (<Conveyor condition file No.>)	1 to 6
		CTP= <Conveyor position at teaching (mm)>	
		V= <Play speed>	V: 0.1 to 1500.0 mm/sec. 0.6 to 9000.0 cm/min.
Example	SYMOVL V=200.0 CV#(1) CTP=100.000		
SYMOVC	Function	Moves in circular interpolation in synchronization with the conveyor.	
	Instruction items	CV# (<Conveyor condition file No.>)	1 to 6 Can be omitted.
		CTP= <Conveyor position at teaching (mm)>	
		V= <Play speed>	V: 0.1 to 1500.0 mm/sec. 0.6 to 9000.0 cm/min.
Example	SYMOVC V=200.0 CV#(1) CTP=100.000		
SYEND	Function	Ends the conveyor synchronized operation.	
	Instruction items	CV# (<Conveyor condition file No.>)	1 to 6
	Example	SYEND CV#(1)	

*1 SYMOVJ can be used only when synchronizing with a base axis.

13 Alarm List

Alarm No.	Message	Causes	Corrective Actions
1003	ROM ERROR (NCP02)		Replace the YCP02 board (ROM).
1109	SYSTEM ERROR (CONVEYOR) [10], Decimal Data: 0 to 255	Internal error.	Replace the YCP02 board.
1400	CONVEYOR ENCONDER ERROR [Error occurred conveyor No: 1, 2, 3]	Conveyor encoder error at the error occurred conveyor No.	Replace the encoder cable or the encoder.
1401	CANNOT CHANGE CONVEYOR MODE	The encoder mode "ENCODER/ VIRTUAL ENCDR" has been switched by the general purpose input signal during the conveyor synchronized operation.	Switch the encoder mode by the general purpose input signal while the manipulator is not in the conveyor synchronized operation.
4021	MEMORY ERROR (CONVEYOR CONDITION FILE) [10], Decimal Data: 0 to 255	The conveyor condition file data in the memory has been destroyed.	Initialize the conveyor condition file in customer maintenance mode.
4530	CONVEYOR SYNCHRONIZATION ERROR [10], Decimal Data; 0 to 255	1: The base axis specification in the conveyor condition file is set to other than 0, 1, and 2. 2: The robot axis for tracking robot axis does not exist. 3: The base axis does not exist in the job for tracking the base axis. The error data other than 1, 2, and 3 is an internal error.	Turn the power OFF then back ON. If the alarm occurs again, contact your YASKAWA representative.
4531	UNDEFINED CONVEYOR COND FILE [10], Decimal Data: 0 to 255	The conveyor condition file specified for the job is not set for use.	Set the conveyor condition file to "USED"
4532	CONVEYOR SPEED DOWN [10], Decimal Data: 0 to 255	When the mode for conveyor speed down mode in the conveyor condition file is set to "ALARM", the conveyor speed is lowered to less than its lower limit specified in the conveyor condition file.	Increase the conveyor speed so that it becomes larger than the conveyor speed lower limit specified in the conveyor condition file.
4533	ARITHMETIC ERROR [10], Decimal Data, 0 to 255	Internal error.	Turn the power OFF then back ON. If the alarm occurs again, contact your YASKAWA representative.

Alarm No.	Message	Causes	Corrective Actions
4538	CAN NOT USE SMOVJ DURING TRACKING [10], Decimal Data, 0 to 255	SYMOVJ was executed when a robot axis was used for synchronization.	SYMOVJ can be used only when the base axis is used for synchronization.
5020	SENSOR PARAMETER ERROR [10], Decimal Data: 0 to 255	On the YCP02 board, when parameters were calculated using data in the conveyor condition file, an operation error occurred.	Check whether the data are properly set in the conveyor condition file. Confirm: -that "0" is not set for the user coordinate number. -that "0" is not set for the conveyor positional resolution.
5022	CONVEYOR POSITION LIMIT OVER [Alarm occurred conveyor condition file No: 1, 2, or 3]	The corrected conveyor position value exceeds ± 21 m	Review the synchronized section. After this alarm occurs, the conveyor position is not updated. Therefore, the synchronized operation is not performed after the alarm is reset, and the manipulator continues operation at the position where the alarm occurred.
5023	CONVEYOR COUNTER LIMIT OVER [Alarm occurred conveyor condition file No: 1, 2, or 3]	The conveyor position counter pulse overflowed.	Review the conveyor resolution or the synchronized section. After this alarm occurs, the conveyor position is not updated. Therefore, the synchronized operation is not performed after the alarm is reset, and the manipulator continues operation at the position where the alarm occurred.

14 Sensor Parameters (SxE)

Use the sensor parameters with their initial value settings.

No.	Contents	Initial Value
0	Application designation	16
1	Time to recognize the input of start signal	5
2	Reference time to recognize the occurrence of speed down	100
3	Time for averaging the speed variation amount	60
4	Time to recognize the falling edge of start signal	5

DX100 OPTIONS INSTRUCTIONS

FOR CONVEYOR SYNCHRONIZED FUNCTION

HEAD OFFICE

2-1 Kurosaki-Shiroishi, Yahatanishi-ku, Kitakyusyu-shi, 806-0004, Japan
Phone +81-93-645-7745 Fax +81-93-645-7746

MOTOMAN INC. HEADQUARTERS

805 Liberty Lane, West Carrollton, OH 45449, U.S.A.
Phone +1-937-847-6200 Fax +1-937-847-6277

MOTOMAN ROBOTICS EUROPE AB

Franska Vagen 10, Box 4004, SE-390 04 Kalmar, Sweden
Phone +46-480-417800 Fax +46-480-417999

MOTOMAN ROBOTEC GmbH

Kammerfeld strasse 1, 85391 Allershausen, Germany
Phone +49-8166-90-100 Fax +49-8166-90-103

YASKAWA ELECTRIC KOREA CORPORATION

1F, Samyang Bldg. 89-1, Shinchun-dong, Donk-Ku, Daegu, Korea
Phone +82-53-382-7844 Fax +82-53-382-7845

YASKAWA ELECTRIC (SINGAPORE) PTE. LTD.

151 Lorong Chuan, #04-01, New Tech Park, Singapore 556741
Phone +65-6282-3003 Fax +65-6289-3003

YASKAWA ELECTRIC (MALAYSIA) SDN. BHD.

Unit 47-1 and 2, Jalan PJU 5/9, Dataran Sunway, Kota Damansara, 47810, Petaling Jaya Selangor, Malaysia
Phone +60-3614-08919 Fax +60-3614-08929

YASKAWA ELECTRIC (THAILAND) CO., LTD.

252/246, 4th Floor, Muang Thai-Phatra office Tower II Rechedapisek Road, Huaykwang Bangkok 10320, Thailand
Phone +66-2-693-2200 Fax +66-2-693-4200

SHOUGANG MOTOMAN ROBOT CO., LTD.

No.7, Yongchang-North Road, Beijing Economic and Technological and Development Area, Beijing 100076, China
Phone +86-10-6788-0541 Fax +86-10-6788-0542

MOTOMAN MOTHERSON ROBOTICS LTD.

Plot Number 195-196, First Floor, Imt Manesar -Sector 4, Gurgaon (Haryana), Pin-122050, India
Phone +91-124-475-8500 Fax +91-124-475-8542



YASKAWA ELECTRIC CORPORATION

YASKAWA

Specifications are subject to change without notice
for ongoing product modifications and improvements.



© Printed in Japan MAY 2009 09-05

MANUAL NO.

HW0485517

80/80