

## PanelView Plus 6 Terminals

Catalog Numbers 2711P-K4M5A8, 2711P-K4M5D8, 2711P-K4M20A8, 2711P-K4M20D8, 2711P-K4C5A8, 2711P-B4C5A8, 2711P-K4C5D8, 2711P-B4C5D8, 2711P-K4C20A8, 2711P-B4C20A8, 2711P-K4C20D8, 2711P-B4C20D8, 2711P-K6M5A8, 2711P-T6M5A8, 2711P-B6M5A8, 2711P-K6M5D8, 2711P-T6M5D8, 2711P-B6M5D8, 2711P-K6M20A8, 2711P-T6M20A8, 2711P-B6M20A8, 2711P-K6M20D8, 2711P-T6M20D8, 2711P-B6M20D8, 2711P-K6C5A8, 2711P-T6C5A8, 2711P-B6C5A8, 2711P-K6C5D8, 2711P-T6C5D8, 2711P-B6C5D8, 2711P-K6C20A8, 2711P-T6C20A8, 2711P-B6C20A8, 2711P-K6C20D8, 2711P-T6C20D8, 2711P-B6C20D8, 2711P-K6C5A9, 2711P-T6C5A9, 2711P-B6C5A9, 2711P-K6C5D9, 2711P-T6C5D9, 2711P-B6C5D9, 2711P-K6C20A9, 2711P-T6C20A9, 2711P-B6C20A9, 2711P-K6C20D9, 2711P-T6C20D9, 2711P-B6C20D9, 2711P-K7C4D8, 2711P-T7C4D8, 2711P-B7C4D8, 2711P-K7C4D8K, 2711P-T7C4D8K, 2711P-B7C4D8K, 2711P-K7C4A8, 2711P-T7C4A8, 2711P-B7C4A8, 2711P-K10C4D8, 2711P-T10C4D8, 2711P-B10C4D8, 2711P-K10C4A8, 2711P-T10C4A8, 2711P-B10C4A8, 2711P-K12C4D8, 2711P-T12C4D8, 2711P-B12C4D8, 2711P-K12C4D8K, 2711P-T12C4D8K, 2711P-B12C4D8K, 2711P-K12C4A8, 2711P-T12C4A8, 2711P-B12C4A8, 2711P-K15C4D8, 2711P-T15C4D8, 2711P-B15C4D8, 2711P-K15C4A8, 2711P-T15C4A8, 2711P-B15C4A8, 2711P-K7C4D9, 2711P-T7C4D9, 2711P-B7C4D9, 2711P-K7C4A9, 2711P-T7C4A9, 2711P-B7C4A9, 2711P-K10C4D9, 2711P-T10C4D9, 2711P-B10C4D9, 2711P-K10C4A9, 2711P-T10C4A9, 2711P-B10C4A9, 2711P-K12C4D9, 2711P-T12C4D9, 2711P-B12C4D9, 2711P-K12C4A9, 2711P-T12C4A9, 2711P-B12C4A9, 2711P-K15C4D9, 2711P-T15C4D9, 2711P-B15C4D9, 2711P-K15C4A9, 2711P-T15C4A9, 2711P-B15C4A9



## Important User Information

Read this document and the documents listed in the additional resources section about installation, configuration, and operation of this equipment before you install, configure, operate, or maintain this product. Users are required to familiarize themselves with installation and wiring instructions in addition to requirements of all applicable codes, laws, and standards.

Activities including installation, adjustments, putting into service, use, assembly, disassembly, and maintenance are required to be carried out by suitably trained personnel in accordance with applicable code of practice.

If this equipment is used in a manner not specified by the manufacturer, the protection provided by the equipment may be impaired.

In no event will Rockwell Automation, Inc. be responsible or liable for indirect or consequential damages resulting from the use or application of this equipment.

The examples and diagrams in this manual are included solely for illustrative purposes. Because of the many variables and requirements associated with any particular installation, Rockwell Automation, Inc. cannot assume responsibility or liability for actual use based on the examples and diagrams.

No patent liability is assumed by Rockwell Automation, Inc. with respect to use of information, circuits, equipment, or software described in this manual.

Reproduction of the contents of this manual, in whole or in part, without written permission of Rockwell Automation, Inc., is prohibited.

Throughout this manual, when necessary, we use notes to make you aware of safety considerations.



**WARNING:** Identifies information about practices or circumstances that can cause an explosion in a hazardous environment, which may lead to personal injury or death, property damage, or economic loss.



**ATTENTION:** Identifies information about practices or circumstances that can lead to personal injury or death, property damage, or economic loss. Attentions help you identify a hazard, avoid a hazard, and recognize the consequence.

---

### IMPORTANT

Identifies information that is critical for successful application and understanding of the product.

---

Labels may also be on or inside the equipment to provide specific precautions.



**SHOCK HAZARD:** Labels may be on or inside the equipment, for example, a drive or motor, to alert people that dangerous voltage may be present.



**BURN HAZARD:** Labels may be on or inside the equipment, for example, a drive or motor, to alert people that surfaces may reach dangerous temperatures.



**ARC FLASH HAZARD:** Labels may be on or inside the equipment, for example, a motor control center, to alert people to potential Arc Flash. Arc Flash will cause severe injury or death. Wear proper Personal Protective Equipment (PPE). Follow ALL Regulatory requirements for safe work practices and for Personal Protective Equipment (PPE).

---

	<b>Preface</b>	
	Summary of Changes .....	7
	Package Contents .....	7
	Firmware Upgrades .....	7
	Additional Resources .....	7
	<b>Chapter 1</b>	
<b>Overview</b>	About the Terminals .....	9
	Windows CE Operating System .....	10
	Open versus Closed System .....	10
	Start-up Options .....	11
	Desktop Access .....	11
	Software Support .....	11
	400 and 600 Terminal Features .....	12
	700 to 1500 Terminal Features .....	15
	400/600 Terminal Selections .....	18
	700 to 1500 Terminal Selections .....	19
	Accessories .....	20
	<b>Chapter 2</b>	
<b>Install Terminal</b>	Mounting Clearances .....	28
	Panel Guidelines .....	28
	Panel Cutout Dimensions .....	28
	Product Dimensions .....	29
	Mount the 400/600 Terminal in a Panel .....	31
	Mount the 700 to 1500 Terminal in a Panel .....	33
	Remove and Install the Power Terminal Block .....	35
	DC Power Connections .....	36
	AC Power Connections .....	39
	Initial Startup .....	41
	Reset the Terminal .....	41
	<b>Chapter 3</b>	
<b>Configuration Mode</b>	Access Configuration Mode .....	43
	Terminal Settings .....	46
	Load and Run Application .....	48
	Start-up Options .....	49
	Desktop Access .....	52
	Communication Setup .....	56
	Ethernet Network Connections .....	58
	File Management .....	62
	Display Settings .....	65
	Input Device Settings .....	67
	Configure Print Options .....	70

Check Integrity of Application Files .....	72
Configure Diagnostics .....	73
View and Clear the System Event Log .....	74
System Information .....	74
Enable or Disable the Alarm Display .....	76
Time and Date Settings .....	77
Regional Settings .....	79
Font Linking .....	82

#### **Chapter 4**

### **Windows CE Operating System**

Windows CE 6.0 Standard Features .....	83
Windows CE 6.0 with Extended Features .....	85
Windows Explorer .....	86
Taskbar .....	86
Input Panels .....	86
Windows Control Panel .....	87
Backup and Restore .....	88
Hardware Monitor .....	91
Keypad Properties .....	93
Touch Properties .....	93
Display Properties .....	94
Logo Manager .....	96
System Information .....	97
User Accounts .....	100
Services .....	101
Network Server Configuration .....	102
Printer Support .....	111
PDF Reader .....	114
Image Viewer .....	115

#### **Chapter 5**

### **Install and Replace Components**

Required Tools .....	117
Install or Replace the Logic Module .....	118
Install or Replace a Communication Module .....	119
Replace the Display Module .....	121
Replace the Bezel .....	122
Replace the Backlight .....	124
Replace the Battery .....	128
Install the AC Power Supply Module .....	130
Remove the Product ID Label .....	132
Replace the Keypad Legend Inserts .....	132
Load an SD Card .....	134
Clean the Display .....	134

	<b>Chapter 6</b>	
<b>Terminal Connections</b>	USB Ports .....	138
	Ethernet Connections .....	140
	Serial Connections .....	142
	DH-485/DH+ Communication Module .....	145
	ControlNet Communication Module .....	148
	Controller Connections .....	151
	<b>Chapter 7</b>	
<b>Firmware Upgrades</b>	Terminal Firmware .....	153
	Download Firmware Files .....	154
	Firmware Upgrade Wizard .....	154
	Upgrade Terminal Firmware from a Storage Device .....	155
	Upgrade Terminal Firmware over the Network .....	158
	<b>Chapter 8</b>	
<b>Troubleshooting</b>	Status Indicators .....	161
	Terminal Does Not Start Properly .....	162
	Start-up Messages and Codes .....	164
	Check Terminal Components .....	166
	Ethernet Connection .....	167
	Program Launcher ActiveX Control .....	168
	Application Does Not Run .....	168
	Configuration Mode Access .....	168
	File System Errors .....	169
	Advanced Diagnostics .....	169
	Access Maintenance Operations .....	170
	Restore Factory Defaults .....	172
	<b>Appendix A</b>	
<b>Fonts Resident on Terminal</b>	True Type Fonts .....	175
	<b>Appendix B</b>	
<b>Outdoor Installations for High-bright Displays</b>	Important Considerations .....	177
	Using an Antiglare Overlay .....	177
	Using a Solar Visor .....	177
	Selecting an Enclosure .....	178
	Backlight Considerations .....	178
	Orientation of the Terminal .....	178
	<b>Index</b>	

**Notes:**

This manual describes how to install, configure, operate, and troubleshoot PanelView™ Plus 6 terminals. It does not provide procedures on how to create applications that run on the terminal.

You need to do the following:

- Use FactoryTalk® View Studio for Machine Edition software to create an HMI application to run in the terminal.
- Create ladder logic to interact with the HMI application.

## Summary of Changes

This publication contains new and updated information as indicated in the following table.

Topic	Pages
Updated the power supply catalog number.	16, 23, 37
Added catalog numbers for the new SDHC cards.	16, 16

## Package Contents

This product is shipped with the following items:

- Terminal with FactoryTalk View Machine Edition runtime software installed and activated
- Product information
- Mounting levers for installing 400 and 600 terminals
- Mounting clips for installing 700 to 1500 terminals
- Panel cutout template

## Firmware Upgrades

For the latest firmware upgrades and other downloads for PanelView Plus 6 terminals, go to <http://www.rockwellautomation.com/support> and click Firmware Updates.

## Additional Resources

These documents contain additional information concerning related products from Rockwell Automation.

Resource	Description
PanelView Plus Specifications Technical Data, publication <a href="#">2711P-TD005</a>	Provides technical specifications, environmental specifications, and certifications for the PanelView Plus 6 platform.
Industrial Automation Wiring and Grounding Guidelines, publication <a href="#">1770-4.1</a>	Provides general guidelines for installing a Rockwell Automation® industrial system.
Product Certifications website, <a href="http://rok.auto/certifications">rok.auto/certifications</a>	Provides declarations of conformity, certificates, and other certification details.

You can view or download publications at <http://www.rockwellautomation.com/global/literature-library/overview.page>.

**Notes:**



## Overview

<b>Topic</b>	<b>Page</b>
Windows CE Operating System	10
Open versus Closed System	10
Desktop Access	11
Software Support	11
400 and 600 Terminal Features	12
700 to 1500 Terminal Features	15
400/600 Terminal Selections	18
700 to 1500 Terminal Selections	19
Accessories	20

## About the Terminals

PanelView™ Plus 6 terminals are operator interface devices that run HMI machine-level applications in an industrial environment. The displays range in size from 4 to 15 inches. These devices are used to monitor, control, or display information graphically, letting operators quickly understand the status of their application.









This platform is programmed by using common development software that provides multilingual support, and integrates into systems with Rockwell Automation controllers including preferred Logix controllers.

## Windows CE Operating System

PanelView Plus 6 terminals run the Windows CE operating system (OS), providing the foundational OS elements for the majority of user needs.

For users with more complex application requirements, some of the terminals offer optional, extended features and file viewers.

**Table 1 - Operating System Features**

Features	400 Terminals	600 Terminals		700 to 1500 Terminals	
Cat. No.	2711P-xxxx8	2711P-xxxx8	2711P-xxxx9	2711P-xxxx8 2711P-RP8x	2711P-xxxx9 2711P-RP9x
<b>Standard Features</b>					
FTP server	X	X	X	X	X
VNC client/server	X	X	X	X	X
ActiveX controls <sup>(1)</sup>	X	X	X	X	X
Third-party device support	X	X	X	X	X
PDF reader 	X	X	X	X	X
<b>Optional Extended Features</b>					
Web browser - Internet Explorer 	—	—	X	—	X
Remote desktop connection 	—	—	X <sup>(2)</sup>	—	X
Media player 	—	—	X	—	X
Microsoft Office file viewers					
• PowerPoint 	—	—	X	—	X
• Excel 	—	—	X	—	X
• Word 	—	—	X	—	X
WordPad text editor 	—	—	X	—	X

(1) Refer to [Display FactoryTalk View ME Station Information on page 76](#) for a list of ActiveX controls loaded on a terminal.

(2) The remote desktop connection is not currently supported on PanelView Plus 6 - 600 terminals with extended features.

## Open versus Closed System

The terminals can be configured to run an open or closed desktop environment:

- An open system launches the Windows Explorer desktop on startup. The system is configurable via the control panel and supports Windows operations.
- A closed system launches a FactoryTalk® View Machine Edition application on startup and restricts access to the Windows Explorer desktop.

All terminals are shipped as closed systems restricting access to the desktop. The first time you start the system, the terminal launches FactoryTalk View ME Station Configuration mode. At this point, you can change the start-up option and allow desktop access.

## Start-up Options

You can configure the terminal to perform one of three actions at startup:

- Launch a FactoryTalk View Machine Edition HMI application.
- Launch the FactoryTalk View Machine Edition Configuration mode of the terminal where you load and run applications, configure start-up options and terminal settings, and enable or disable desktop access.
- Launch the Windows Explorer desktop.

The factory default state and start-up option following a firmware upgrade is to launch the terminal in Configuration mode. Refer to [Start-up Options on page 49](#) for details on how to change the start-up option.

## Desktop Access

Any of the terminals can be configured to allow or restrict desktop access. From the desktop, you can perform system and control panel operations, or run third-party applications. Terminals with optional, extended features (catalog numbers ending in 9) can additionally run viewers, media players, and launch the web browser. You can even allow access temporarily to perform specific tasks, then disable desktop access to prevent unauthorized changes.

**TIP** All terminals are initially shipped with desktop access disabled.

Refer to [Desktop Access on page 52](#) for details on how to modify desktop access.

---

**IMPORTANT** Desktop access does not change the feature set of your terminal. If you have a terminal with a catalog number ending in 8, opening the desktop does not give you access to extended features and file viewers.

---

## Software Support

The table lists software supported on the terminals.

**Table 2 - PanelView Plus 6 Software Support**

Software	Description	Version
FactoryTalk View Machine Edition Station	Runtime environment for FactoryTalk View Machine Edition .mer applications. Machine Edition Station is preloaded on each terminal and does not require FactoryTalk View activation.	<ul style="list-style-type: none"> <li>• 6.10 or later (400 and 600 terminals)</li> <li>• 6.0 or later (700 to 1500 terminals)</li> </ul>
FactoryTalk View Studio for Machine Edition	Configuration software for developing HMI applications that run on PanelView Plus 6 terminals. RSLinx <sup>®</sup> Enterprise software is included with FactoryTalk View Studio software and loaded during installation.	
FactoryTalk ViewPoint (700 to 1500 terminals only)	Add-on capability provided with FactoryTalk View Studio software: <ul style="list-style-type: none"> <li>• This web-based, thin-client solution lets manufacturers or casual users monitor or download changes to a running Machine Edition application from remote locations via an Internet browser.</li> <li>• A single license is embedded with each terminal supporting a single client connection to terminal. No additional software is required.</li> </ul>	1.2 or later
Windows CE 6.0 OS	Operating system that runs on all terminals.	6.0

## 400 and 600 Terminal Features

Both the 400 and 600 terminals provide these communication options:

- RS-232 serial port only or
- Ethernet port and RS-232 serial port

**Figure 1 - 400 Keypad or Keypad/Touch Terminals**

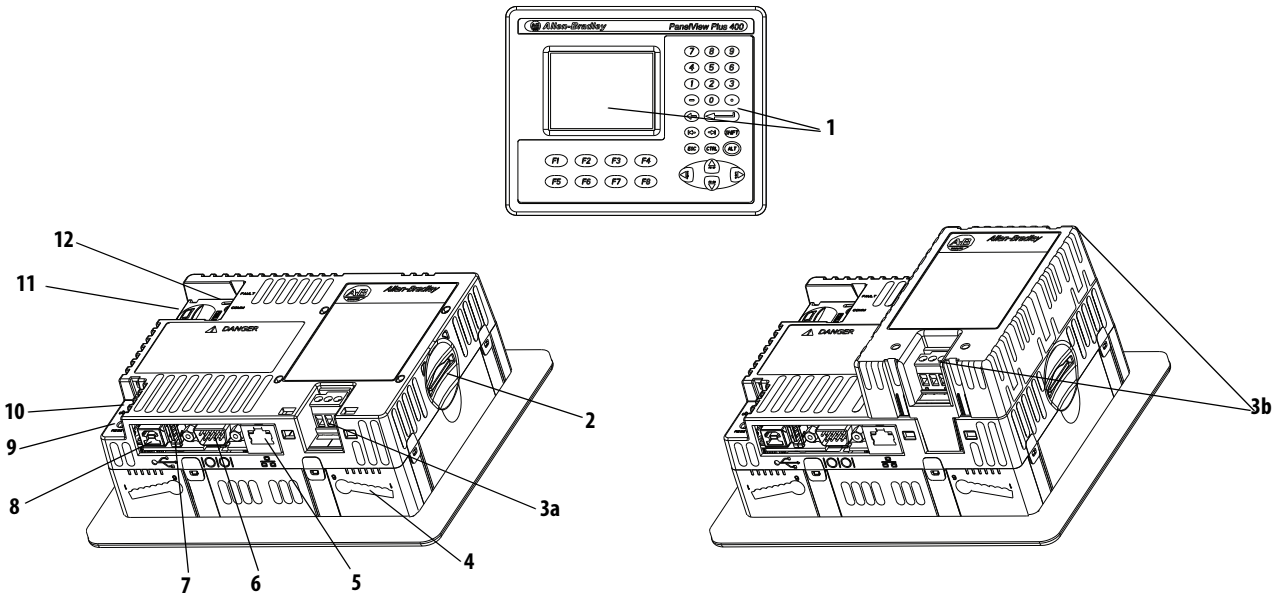

**Table 3 - PanelView Plus 6 - 400 Terminal Components**

Item	Component
1	3.5-in. grayscale or color display with one of these operator input options: <ul style="list-style-type: none"> <li>• Keypad</li> <li>• Combination keypad and touch screen</li> </ul>
2	Secure Digital (SD) card slot supporting cat. no. 1784-SDx cards
3a	DC power input, nonisolated <sup>(1)</sup> 24V DC nom (18...30V DC)
3b	AC power supply module with AC power input <sup>(1)</sup> 100...240V AC (50...60 Hz)
4	Mounting slots (four)
5	Ethernet port for controller communication, 10/100Base-T, Auto MDI/MDI-X <sup>(2)</sup>
6	RS-232 serial port for controller communication, printing, or file transfers
7	One USB 2.0 high-speed (type A) host port for attaching USB peripherals including mouse, keyboard, printer, and USB drives that are hot-swappable in nonhazardous locations
8	One USB 2.0 high-speed (type B) device port for connecting a host computer
9	Reset switch to reset the terminal without having to power off and on
10	Default switch to access maintenance operations such as restoring factory defaults
11	Battery compartment
12	Indicators provide communication and fault status

(1) Presence of a DC power input or AC power supply module is catalog number dependent. Removing the AC power supply module voids the terminal warranty.

(2) Presence of Ethernet port is catalog number dependent.

Figure 2 - 600 Touch Terminals

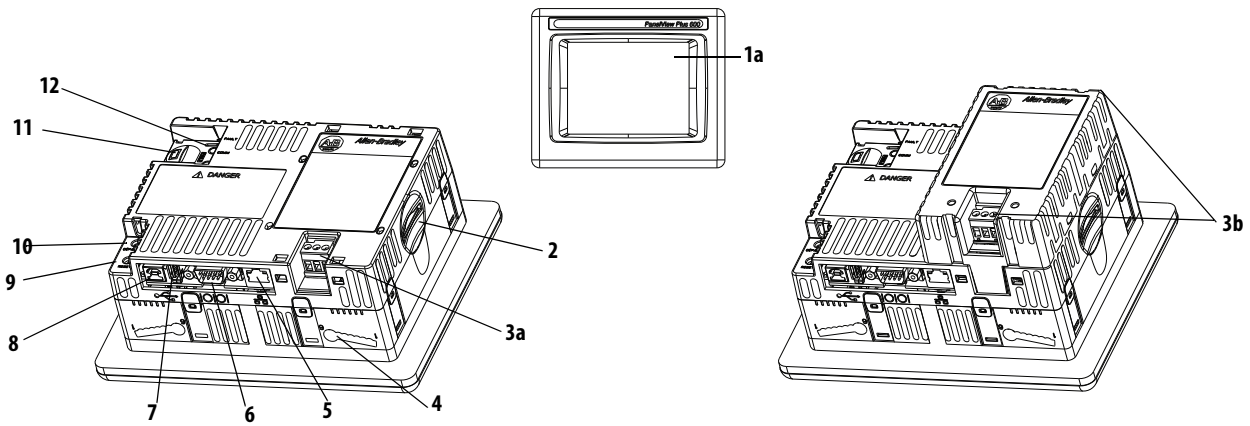

Figure 3 - 600 Keypad or Keypad/Touch Terminals

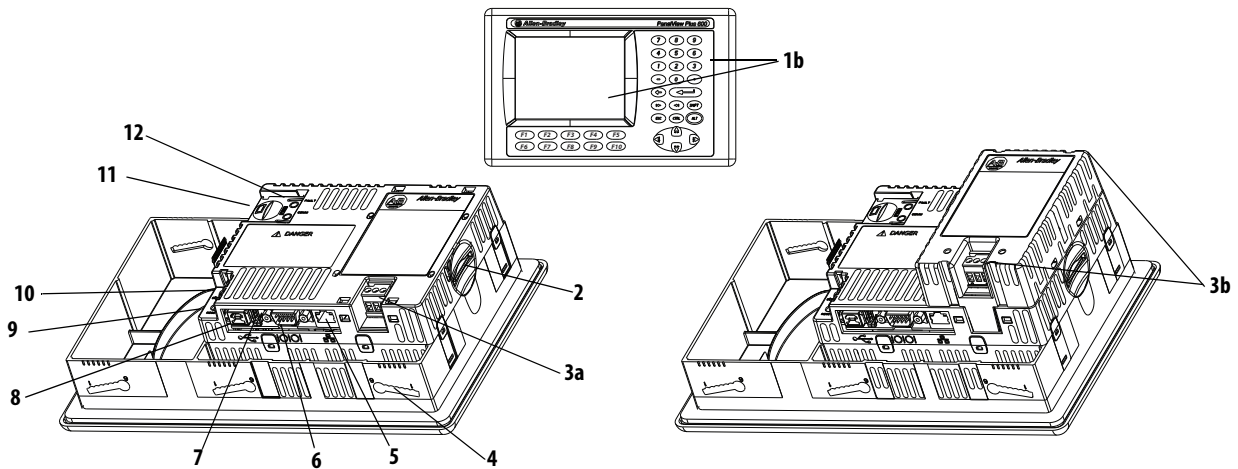

Table 4 - PanelView Plus 6 - 600 Terminal Components

Item	Component	Item	Component
1a	5.7-in. color or grayscale display with a touch screen	6	RS-232 serial port for controller communication, printing, or file transfers
1b	5.7-in. color or grayscale display with either a: <ul style="list-style-type: none"> <li>• Keypad</li> <li>• Combination keypad and touch screen</li> </ul>	7	One USB 2.0 high-speed (type A) host port for attaching USB peripherals including mouse, keyboard, printer, and USB drives that are hot-swappable in nonhazardous locations
2	Secure Digital (SD) card slot supporting cat. no. 1784-SDx cards	8	One USB 2.0 high-speed (type B) device port for connecting a host computer
3a	DC power input, nonisolated <sup>(1)</sup> 24V DC nom (18...30V DC)	9	Reset switch to reset the terminal without having to power off and on
3b	AC power supply module with AC power input <sup>(1)</sup> 100...240V AC (50...60 Hz)	10	Default switch to access maintenance operations such as restoring factory defaults
4	Mounting slots (four on touch terminals; six on keypad terminals)	11	Battery compartment
5	Ethernet port for controller communication, 10/100Base-T, Auto MDI/MDI-X <sup>(2)</sup>	12	Indicators provide communication and fault status

(1) Presence of a DC power input or the AC power supply module is catalog number dependent. Removing the AC power supply module voids the terminal warranty.

(2) Presence of Ethernet port is catalog number dependent.

The terminals feature grayscale or color LCD displays with these input options.

**Table 5 - Operator Input Options**

Terminal	Display Type	Keypad	Touch	Key and Touch
400	Grayscale	•		
	Color	•		•
600	Grayscale	•	•	•
	Color	•	•	•

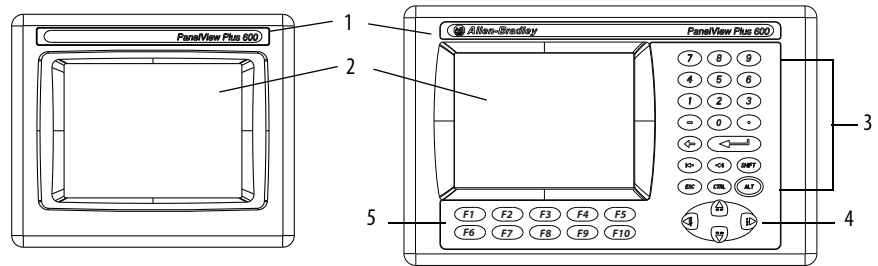

**Table 6 - Display and Operator Input Features**

Item	Feature	Description
1	Product label	Product identification label can be replaced with custom label.
2	Display/touch screen	Color or grayscale display with or without a resistive, 4-wire, touch screen (catalog number dependent)
3	Numeric keypad	0 . . 9, Backspace, Enter, Left and Right Tab, Esc, Shift, Ctrl, Alt keys
4	Navigation keys	Use arrow keys for navigation. Use Alt+arrow to initiate these functions: <ul style="list-style-type: none"> <li>• Alt+left arrow (Home), Alt+right arrow (End)</li> <li>• Alt+up arrow (Page Up), Alt+down arrow (Page Down)</li> </ul>
5	Function keys	Keys that can be configured in the application to perform operations. For example, F1 can be configured to navigate to another screen. <ul style="list-style-type: none"> <li>• F1 . . . F8</li> <li>• F1 . . . F10</li> </ul>



**ATTENTION:** Use a finger or gloved finger to operate the keypad. To operate the touch screen, use a finger, gloved-finger or plastic stylus with a minimum tip radius of 1.3 mm (0.051 in.). Using any other object or tool can damage the keypad or touch screen.



**ATTENTION:** Do not carry out multiple operations simultaneously. Doing so can result in unintended operation:

- Touch only one operating element on the screen with one finger at one time.
- Press only one key on the terminal at one time.

## 700 to 1500 Terminal Features

The larger 700 to 1500 terminals consist of modular components ordered separately or as configured terminals. The modular components consist of the following:

- Display module
- Logic module
- Optional communication module

These components provide for flexible configuration, installation, and upgrades. You can order a factory-assembled unit with a single catalog number or separate components for field installation.

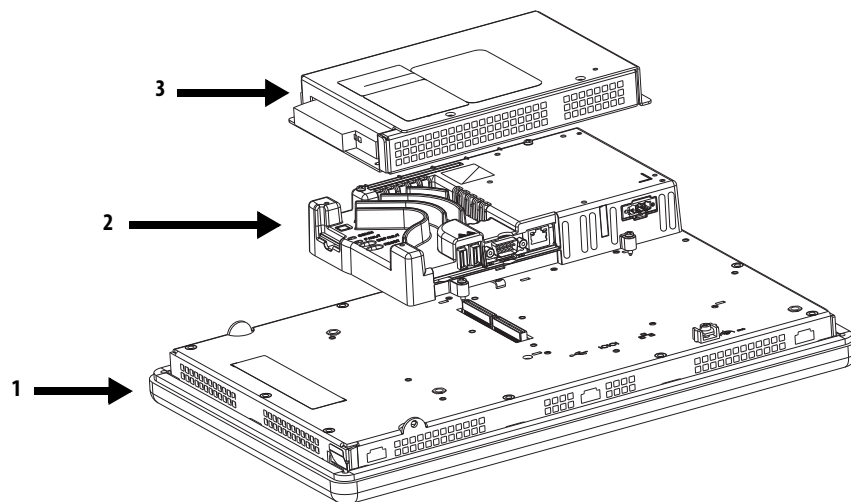

**Table 7 - Modular Components**

Item	Terminal Component	Description	Options for Environmental Conditions
1	Display module	Flat panel, color graphic display in four sizes with keypad, touch-screen, or combination keypad/touch-screen input: <ul style="list-style-type: none"> <li>• 700 (6.5-in.)</li> <li>• 1000 (10.4-in.)</li> <li>• 1250 (12.1-in.)</li> <li>• 1500 (15-in.)</li> </ul>	Display modules are also available with these characteristics: <ul style="list-style-type: none"> <li>• Marine-certified</li> <li>• Conformal-coated</li> <li>• High-bright display for outdoor use</li> <li>• Built-in antiglare overlay</li> </ul>
2	Logic module	The logic module has these hardware features: <ul style="list-style-type: none"> <li>• Power input, AC or DC</li> <li>• RS-232 serial port</li> <li>• Ethernet port</li> <li>• 2 USB 2.0 host ports</li> <li>• Network interface for optional communication module</li> <li>• 512 MB RAM memory and 512 MB nonvolatile memory (approx. 79 MB free user memory)</li> <li>• Secure Digital (SD) card slot</li> <li>• Battery-backed real-time clock</li> <li>• Status indicators</li> <li>• Reset switches</li> <li>• Single PCI slot</li> </ul>	Logic modules are also available with these characteristics: <ul style="list-style-type: none"> <li>• Marine-certified</li> <li>• Conformal-coated</li> </ul>
3	Communication module	Optional module for communication with these networks: <ul style="list-style-type: none"> <li>• DH+™/DH-485</li> <li>• ControlNet scheduled and unscheduled</li> <li>• Ethernet</li> </ul>	Communication modules are also available with these characteristics: <ul style="list-style-type: none"> <li>• Marine-certified</li> <li>• Conformal-coated</li> </ul>

## Configured Terminals

A configured terminal, ordered as a single-catalog number, has a display module and logic module.

An optional DH+/DH-485, ControlNet, or Ethernet communication module can be added later for additional network capabilities.

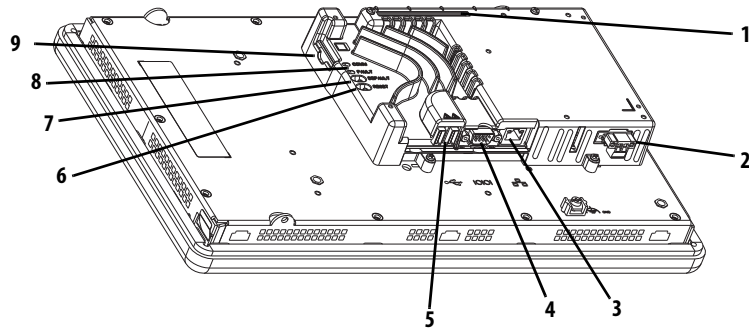

**Table 8 - Logic Module Features**

Item	Feature
1	Network interface connector for optional communication module
2	AC or DC power input <sup>(1)</sup> <ul style="list-style-type: none"> <li>• Isolated 18...32V DC</li> <li>• 100...240V AC</li> </ul>
3	Ethernet port for controller communication, 10/100 BaseT, Auto MDI/MDI-X
4	RS-232 serial port for file transfers, printing, and controller communication
5	Two USB 2.0 high-speed (type A) host ports for attaching USB devices including mouse, keyboard, printer, and USB drives that are hot-swappable in nonhazardous locations
6	Reset switch to reset the terminal without having to power on and off
7	Default switch to access maintenance operations such as restoring factory defaults
8	Indicators provide communication and fault status
9	Secure Digital (SD) card slot supporting cat. no. 1784-SDx and 1784-SDHCx cards

(1) For DC applications using AC power, an external, remote AC-to-DC power supply, cat. no. 1606-XLE120E, is available for DIN-rail mounting.



## Operator Input

All 700 to 1500 display modules have TFT color, graphic displays with either keypad, touch screen, or combination keypad/touch-screen input. Common features and firmware provide for easy migration to a larger display:

- Eight-wire resistive touch screens are extremely accurate for operator interfaces. When a point on the touch screen is pressed, the layers connect and change the electrical current, which is then registered and processed.
- All keypad or combination keypad/touch-screen displays are similar except for the number of functions keys.

To meet the requirements of specific environmental conditions, high-bright displays, marine-certified displays, and conformal-coated displays are also available. Plus, you can order field replaceable bezels.

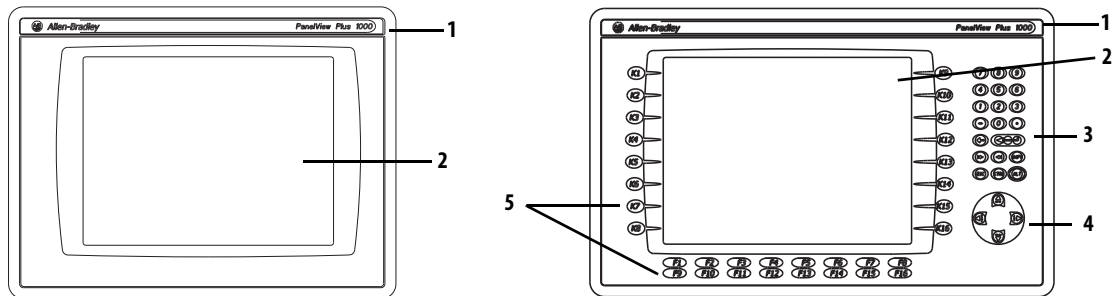

**ATTENTION:** Keypad Operation - Use only a finger or gloved finger to operate. Touch screen Operation - Use only a finger, gloved finger, or plastic stylus with a minimum tip radius of 1.3mm (0.051 in.) to operate. Using any other object or tool not described above may cause damage to the device and is not warranted by Rockwell Automation.



**ATTENTION:** Do not carry out multiple operations simultaneously. Doing so can result in unintended operation:

- Touch only one operating element on the screen with one finger at one time.
- Press only one key on the terminal at one time.

**Table 9 - Display Features**

Item	Feature	Description
1	Replaceable ID Label	Product identification label can be replaced with custom label.
2	Display	Analog resistive touch screen applies to touch-screen or combination keypad/touch-screen terminals.
3	Numeric keypad	0 . . 9, -, Backspace, Enter, Left and Right tab, Shift, Esc, Ctrl, Alt keys.
4	Navigation keys	Use arrow keys for navigation. Use Alt+arrow to initiate these functions: <ul style="list-style-type: none"> <li>• Alt+left arrow (Home), Alt+right arrow (End)</li> <li>• Alt+up arrow (Page Up), Alt+down arrow (Page Down)</li> </ul>
5	Function keys 700 F1 ... F10, K1 ... K12 1000 F1 ... F16, K1 ... K16 1250 F1 ... F20, K1 ... K20 1500 F1 ... F20, K1 ... K20	Keys that can be configured in the application to perform operations. For example, F1 can be configured to navigate to another screen. Replaceable legends are available to customize the function key labels.

## 400/600 Terminal Selections

The table shows the catalog number breakdown for the 400 and 600 terminals.

Bulletin	Input Type	Display Size	Display Type	Communication	Power	Operating System
2711P-	K = Keypad	4= 3.5 in.	C = Color	5 = RS-232, USB	A = AC	8 = Windows CE 6.0
	B = Keypad and Touch	6 = 5.7 in.	M = Grayscale	20 = Ethernet, RS-232, USB	D = DC	9 = Windows CE 6.0 with extended features
	T = Touch					

**Table 10 - PanelView Plus 6 - 400 Terminals without Extended Features**

Cat. Nos.		Display		Communication Ports		USB Ports		Input Power	Memory (MB) <sup>(1)</sup>	
Keypad	Keypad and Touch	Size	Type	RS-232	Ethernet	Host	Device		RAM	Nonvolatile
2711P-K4M5A8	—	3.5-in.	Grayscale	•		•	•	AC	256	512 (approx. 73 MB free user memory)
2711P-K4M5D8	—			•		•	•	DC		
2711P-K4M20A8	—			•	•	•	•	AC		
2711P-K4M20D8	—			•	•	•	•	DC		
2711P-K4C5A8	2711P-B4C5A8	3.5-in.	Color	•		•	•	AC		
2711P-K4C5D8	2711P-B4C5D8			•		•	•	DC		
2711P-K4C20A8	2711P-B4C20A8			•	•	•	•	AC		
2711P-K4C20D8	2711P-B4C20D8			•	•	•	•	DC		

(1) The terminals support FactoryTalk View Machine Edition software, version 6.10 or later, and the Windows CE 6.0 operating system.

**Table 11 - PanelView Plus 6 - 600 Terminals without Extended Features**

Cat. Nos.			Display		Communication Ports		USB Ports		Input Power	Memory (MB) <sup>(1)</sup>	
Keypad	Touch	Keypad and Touch	Size	Type	RS-232	Ethernet	Host	Device		RAM	Nonvolatile
2711P-K6M5A8	2711P-T6M5A8	2711P-B6M5A8	5.7-in.	Grayscale	•		•	•	AC	256	512 (approx. 73 MB free user memory)
2711P-K6M5D8	2711P-T6M5D8	2711P-B6M5D8			•		•	•	DC		
2711P-K6M20A8	2711P-T6M20A8	2711P-B6M20A8			•	•	•	•	AC		
2711P-K6M20D8	2711P-T6M20D8	2711P-B6M20D8			•	•	•	•	DC		
2711P-K6C5A8	2711P-T6C5A8	2711P-B6C5A8	5.7-in.	Color	•		•	•	AC		
2711P-K6C5D8	2711P-T6C5D8	2711P-B6C5D8			•		•	•	DC		
2711P-K6C20A8	2711P-T6C20A8	2711P-B6C20A8			•	•	•	•	AC		
2711P-K6C20D8	2711P-T6C20D8	2711P-B6C20D8			•	•	•	•	DC		

(1) The terminals support FactoryTalk View Machine Edition software, version 6.10 or later, and the Windows CE 6.0 operating system.

**Table 12 - PanelView Plus 6 - 600 Terminals with Extended Features**

Cat. Nos.			Display		Communication		USB Ports		Input Power	Memory (MB) <sup>(1)</sup>	
Keypad	Touch	Keypad and Touch	Size	Type	RS-232	Ethernet	Host	Device		RAM	Nonvolatile
2711P-K6C5A9	2711P-T6C5A9	2711P-B6C5A9	5.7-in.	Color	•		•	•	AC	256	512 (approx. 73 MB free user memory)
2711P-K6C5D9	2711P-T6C5D9	2711P-B6C5D9			•		•	•	DC		
2711P-K6C20A9	2711P-T6C20A9	2711P-B6C20A9			•	•	•	•	AC		
2711P-K6C20D9	2711P-T6C20D9	2711P-B6C20D9			•	•	•	•	DC		

(1) The terminals support FactoryTalk View Machine Edition software, version 6.10 or later, and the Windows CE 6.0 operating system with extended features and file viewers.

## 700 to 1500 Terminal Selections

The table shows the catalog number breakdown for the 700 to 1500 terminals.

Bulletin	Input Type	Display Size	Display Type	Communication <sup>(1)</sup>	Power	Operating System	Special Option
2711P-	K = Keypad	7 = 6.5 in.	C = Color	4 = Ethernet, RS-232 & (2) USB	A = AC	8 = Windows CE 6.0	K = Conformal-Coated
	T = Touch	10 = 10.4 in.			D = DC	9 = Windows CE 6.0 with extended features	
	B = Keypad/Touch	12 = 12.1 in.					
		15 = 15 in.					

(1) Optional communication modules are available as separate catalog numbers.

**Table 13 - PanelView Plus 6 - 700 to 1500 Terminals without Extended Features**

Cat. No.			Display		Communication		Input Power	Memory (MB) <sup>(1)</sup>	
Keypad	Touch	Keypad/Touch	Size	Type	RS-232	Ethernet		RAM	Nonvolatile
<b>700 Model</b>									
2711P-K7C4D8	2711P-T7C4D8	2711P-B7C4D8	6.5-in.	Color	•	•	DC	512	512 (approx. 79 MB free user memory)
–	2711P-T7C4D8K	–			•	•	DC		
2711P-K7C4A8	2711P-T7C4A8	2711P-B7C4A8			•	•	AC		
<b>1000 Model</b>									
2711P-K10C4D8	2711P-T10C4D8	2711P-B10C4D8	10.4-in.	Color	•	•	DC	512	512 (approx. 79 MB free user memory)
2711P-K10C4A8	2711P-T10C4A8	2711P-B10C4A8			•	•	AC		
<b>1250 Model</b>									
2711P-K12C4D8	2711P-T12C4D8	2711P-B12C4D8	12.1-in.	Color	•	•	DC	512	512 (approx. 79 MB free user memory)
–	2711P-T12C4D8K	–			•	•	DC		
2711P-K12C4A8	2711P-T12C4A8	2711P-B12C4A8			•	•	AC		
<b>1500 Model</b>									
2711P-K15C4D8	2711P-T15C4D8	2711P-B15C4D8	15-in.	Color	•	•	DC	512	512 (approx. 79 MB free user memory)
2711P-K15C4A8	2711P-T15C4A8	2711P-B15C4A8			•	•	AC		

(1) The logic module supports FactoryTalk View Machine Edition software, version 6.0 or later, FactoryTalk ViewPoint software version 1.2 or later, and the Windows CE 6.0 operating system.

**Table 14 - PanelView Plus 6 - 700 to 1500 Terminals with Extended Features**

Cat. No.			Display		Communication		Input Power	Memory (MB) <sup>(1)</sup>	
Keypad	Touch	Keypad/Touch	Size	Type	RS-232	Ethernet		RAM	Nonvolatile
<b>700 Model</b>									
2711P-K7C4D9	2711P-T7C4D9	2711P-B7C4D9	6.5-in.	Color	•	•	DC	512	512 (approx. 79 MB free user memory)
2711P-K7C4A9	2711P-T7C4A9	2711P-B7C4A9			•	•	AC		
<b>1000 Model</b>									
2711P-K10C4D9	2711P-T10C4D9	2711P-B10C4D9	10.4-in	Color	•	•	DC	512	512 (approx. 79 MB free user memory)
2711P-K10C4A9	2711P-T10C4A9	2711P-B10C4A9			•	•	AC		
<b>1250 Model</b>									
2711P-K12C4D9	2711P-T12C4D9	2711P-B12C4D9	12.1-in	Color	•	•	DC	512	512 (approx. 79 MB free user memory)
2711P-K12C4A9	2711P-T12C4A9	2711P-B12C4A9			•	•	AC		
<b>1500 Model</b>									
2711P-K15C4D9	2711P-T15C4D9	2711P-B15C4D9	15-in.	Color	•	•	DC	512	512 (approx. 79 MB free user memory)
2711P-K15C4A9	2711P-T15C4A9	2711P-B15C4A9			•	•	AC		

(1) The logic module supports FactoryTalk View Machine Edition software, version 6.0 or later, FactoryTalk ViewPoint software version 1.2 or later, and the Windows CE 6.0 operating system with extended features and file viewers.

## Accessories

Tables 15...28 list accessories for the PanelView Plus 6 terminals.

**Table 15 - Display Modules - 700 to 1500 Terminals**

Cat. No.	Input Type	Display	Marine Certified	Conformal Coated	Built-in Antiglare Overlay
<b>700 Model</b>					
2711P-RDK7C	Keypad	7-in. color			
2711P-RDK7CK	Keypad		•		
2711P-RDT7C	Touch				
2711P-RDT7CK	Touch		•		
2711P-RDT7CM	Touch		•		
2711P-RDB7C	Keypad/Touch				
2711P-RDB7CK	Keypad/Touch		•		
2711P-RDB7CM	Keypad/Touch		•		
<b>1000 Model</b>					
2711P-RDK10C	Keypad	10-4 in. color			
2711P-RDT10C	Touch				
2711P-RDT10CM	Touch		•		
2711P-RDB10C	Keypad/Touch				
2711P-RDB10CM	Keypad/Touch		•		

Table 15 - Display Modules - 700 to 1500 Terminals

Cat. No.	Input Type	Display	Marine Certified	Conformal Coated	Built-in Antiglare Overlay
<b>1250 Model</b>					
2711P-RDK12C	Keypad	12.1-in. color			
2711P-RDK12CK	Keypad			•	
2711P-RDT12C	Touch				
2711P-RDT12CK	Touch			•	
2711P-RDT12H <sup>(1)</sup>	Keypad/Touch				
2711P-RDT12AG	Touch				•
2711P-RDB12C	Keypad/Touch				
2711P-RDB12CK	Keypad/Touch			•	
<b>1500 Model</b>					
2711P-RDK15C	Keypad	15-in. color			
2711P-RDT15C	Touch				
2711P-RDT15AG	Touch				•
2711P-RDB15C	Keypad/Touch				

(1) H at end of cat. no. refers to 1250 High-bright display module.

Table 16 - Logic Modules - 700 to 1500 Terminals

Cat. No.	Power Input	Memory RAM/Nonvolatile	Communication	Marine Certified	Conformal Coated	Included Software
<b>Without Standard Features</b>						
2711P-RP8A	AC	512 MB/512 MB (approximately 79 MB free user memory)	<ul style="list-style-type: none"> <li>Ethernet</li> <li>RS-232</li> <li>Network interface for communication module</li> </ul>	•		<ul style="list-style-type: none"> <li>Windows CE 6.0 operating system</li> <li>FactoryTalk View Machine Edition runtime, version 6.0 or later</li> <li>FactoryTalk ViewPoint software, version 1.2 or later</li> </ul>
2711P-RP8D	DC			•		
2711P-RP8DK	DC			•	•	
<b>With Extended Features</b>						
2711P-RP9A	AC	512 MB/512 MB (approximately 79 MB free user memory)	<ul style="list-style-type: none"> <li>Ethernet</li> <li>RS-232</li> <li>Network interface communication module</li> </ul>	•		<ul style="list-style-type: none"> <li>Windows CE 6.0 operating system with extended features and file viewers</li> <li>FactoryTalk View Machine Edition runtime, version 6.0 or later</li> <li>FactoryTalk ViewPoint software, version 1.2 or later</li> </ul>
2711P-RP9D	DC			•		
2711P-RP9DK	DC			•	•	

Table 17 - Communication Modules - 700 to 1500 Terminals

Cat. No.	Communication				Conformal Coated	Marine Certified
	Ethernet	DH+	DH-485	ControlNet <sup>(2)</sup>		
2711P-RN6		•	•			
2711P-RN6K		•	•		•	
2711P-RN15S				•		•
2711P-RN15SK				•	•	
2711P-RN20 <sup>(1)</sup>	•					

(1) All terminals have an Ethernet port. The cat. no. 2711P-RN20 module provides an additional Ethernet port.

(2) Scheduled and unscheduled communication.

**Table 18 - Secure Digital (SD) Cards<sup>(1)</sup>**

Cat. No.	Terminal Model	Description
1784-SD1	All terminals	1 GB Secure Digital (SD) card
1784-SD2		2 GB Secure Digital (SD) card
1784-SDHC8		8 GB High Capacity Secure Digital (SD) card
1784-SDHC32		32 GB High Capacity Secure Digital (SD) card
2711C-RCSD		USB to SD adapter for secure digital (SD) card

(1) To help reduce the chance of corruption when you use SD Cards or USB drives with the terminal, Rockwell Automation recommends that you use only the above SD card catalog numbers.

**Table 19 - CCFL Backlight Replacements<sup>(1)</sup>**

Cat. No.	Terminal Model	Series	Number of CCFL Backlights
2711P-RL7C	700	A and B	1
2711P-RL7C2		C and D	1
2711P-RL10C	1000	A	1
2711P-RL10C2		B and C	1
2711P-RL12C	1250	A and B	2
2711P-RL12C2		C	1
2711P-RL15C	1500	B	2

(1) These CCFL-backlight replacement catalog numbers do not apply to LED displays.

**Table 20 - Antiglare Overlays**

Cat. No. <sup>(1)</sup>	Terminal Model	Operator Input		
		Keypad	Touch	Key/Touch
2711P-RGB4	400 grayscale or color	•		•
2711P-RGK6	600 grayscale or color	•		•
2711P-RGT6			•	
2711P-RGK7	700 color	•		•
2711P-RGT7			•	
2711P-RGK10	1000 color	•		•
2711P-RGT10			•	
2711P-RGK12	1250 color	•		•
2711P-RGT12			•	
2711P-RGK15	1500 color	•		•
2711P-RGT15			•	

(1) Three overlays are shipped with each catalog number.

**Table 21 - Solar Visor**

Cat. No.	Terminal Model	Description
2711P-RVT12	1250	Solar visor for 1250 high-bright display module, cat. no. 2711P-RDT12H

**Table 22 - Function Key Legend Kits**

Cat. No.	Terminal Model <sup>(1)</sup>	Description
2711P-RFK6	600 keypad	Blank legend inserts and software
2711P-RFK7	700 keypad	
2711P-RFK10	1000 keypad	
2711P-RFK12	1250 keypad	
2711P-RFK15	1500 keypad	

(1) Applies to keypad and keypad/touch-screen terminals.

**Table 23 - Mounting Hardware**

Cat. No.	Terminal Model	Description	Quantity
2711P-RTFC	400 or 600	Replacement mounting levers	8
2711P-RTMC	700 to 1500	Replacement Mounting clips	8

**Table 24 - Replacement Battery**

Cat. No.	Terminal Model	Description
2711P-RY2032	All terminals	Replacement CR2032 coin-cell equivalent battery

**Table 25 - Cables**

Cat. No.	Terminal Model	Description	Length
2711C-CBL-UU02 <sup>(1)</sup>	700 to 1500	Programming cable that connects the USB device port of the terminal to a USB host port of a computer	2 m (6.5 ft)
6189V-USBCBL2	400 and 600	Programming cable that connects the USB device port of the terminal to a USB host port of a computer	1.8 m (6 ft)

(1) Only for Series A terminals with a mini-USB port, type B.

**Table 26 - Power Supply and Power Terminal Blocks**

Cat. No.	Terminal Model	Description	Quantity
1606-XLE120E	All terminals	DIN-rail power supply, AC-to-DC, 100...240V AC, 50...60 Hz	1
2711P-RVAC	400 and 600	AC power terminal block	10
2711P-6RSA		AC module converts a DC-powered terminal to AC power	1
2711P-TBDC		DC power terminal block	10
2711P-RTBAC3	700 to 1500	AC power terminal block	10
2711P-RTBDC2		DC power terminal block	10

**Table 27 - Bezel Replacements**

Cat. No.	Terminal Model	Operator Input		
		Keypad	Touch	Key/Touch
2711P-RBK7	700	.		
2711P-RBT7			.	
2711P-RBB7				.
2711P-RBK10	1000	.		
2711P-RBT10			.	
2711P-RBB10				.
2711P-RBK12	1250	.		
2711P-RBT12			.	
2711P-RBT12H <sup>(1)</sup>			.	
2711P-RBB12				.
2711P-RBK15	1500	.		
2711P-RBT15			.	
2711P-RBB15				.

(1) Applies to the cat. no. 2711P-RDT12H 1250 high-bright display module.

**Table 28 - Adapter Plates**

Cat. No.	Adapts This PanelView Plus 6 Terminal	To This Terminal Cutout
2711P-RAK4	400 keypad or keypad/touch 600 touch	PanelView Standard 550 keypad
2711P-RAK6	600 keypad or keypad/touch	PanelView Standard 600 keypad
2711P-RAK7	700 keypad or keypad/touch	PanelView Standard 900 keypad
2711P-RAT7	700 touch	PanelView Standard 900 touch
2711P-RAK10	1000 keypad or keypad/touch	PanelView 1000/1000e keypad
2711P-RAT10	1000 touch	PanelView 1000/1000e touch
2711P-RAK15	1500 keypad or keypad/touch	PanelView 1200e/1400e keypad
2711P-RAT15	1500 touch	PanelView 1200e/1400e touch
2711P-RAK12E	1250 keypad <sup>(1)</sup>	PanelView 1200/1400e keypad
2711P-RAT12E2	1250 touch <sup>(2)</sup>	PanelView 1200 touch
2711P-RAT12E	1250 touch <sup>(2)</sup>	PanelView 1200e/1400e touch
2711P-RAK12S	1250 keypad <sup>(1)</sup> or keypad/touch	PanelView Standard 1400 keypad
2711P-RAT12S	1250 touch <sup>(2)</sup>	PanelView Standard 1400 touch

(1) Applies also to PanelView 1000/1000e keypad or keypad/touch terminals.

(2) Applies also to PanelView 1000/1000e touch terminals.



## Install Terminal

Topic	Page
Required Circuit Parameters for USB Peripheral Devices	27
Mounting Clearances	28
Panel Guidelines	28
Panel Cutout Dimensions	28
Remove and Install the Power Terminal Block	35
Mount the 400/600 Terminal in a Panel	31
Mount the 700 to 1500 Terminal in a Panel	33
Remove and Install the Power Terminal Block	35
DC Power Connections	36
AC Power Connections	39
Initial Startup	41
Reset the Terminal	41



### ATTENTION: Environment and Enclosure

This equipment is intended for use in a Pollution Degree 2 industrial environment, in overvoltage Category II applications (as defined in IEC 60664-1), at altitudes up to 2000 m (6561 ft) without derating.

The terminals are intended for use with programmable logic controllers. Terminals that are AC powered must be connected to the secondary of an isolating transformer.

This equipment is considered Group 1, Class A industrial equipment according to IEC CISPR 11. Without appropriate precautions, there may be difficulties with electromagnetic compatibility in residential and other environments due to conducted or radiated disturbances.



Korean Radio Wave Suitability Registration - When so marked this equipment is registered for Electromagnetic Conformity Registration as business equipment (A), not home equipment. Sellers or users are required to take caution in this regard.

This equipment is supplied as open-type equipment. It must be mounted within an enclosure that is suitably designed for those specific environmental conditions that will be present and appropriately designed to prevent personal injury resulting from accessibility to live parts. The interior of the enclosure must be accessible only by the use of a tool. The terminals meet specified NEMA, UL type, and IEC ratings only when mounted in a panel or enclosure with the equivalent rating. Subsequent sections of this publication may contain additional information regarding specific enclosure type ratings that are required to comply with certain product safety certifications.

In addition to this publication, see the following:

- Industrial Automation Wiring and Grounding Guidelines, publication [1770-4.1](#), for additional installation requirements
- NEMA Standards 250 and IEC 60529, as applicable, for explanations of the degrees of protection provided by different types of enclosure

**North American Hazardous Location Approval**

The following information applies when operating this equipment in hazardous locations.	Informations sur l'utilisation de cet équipement en environnements dangereux.
<p>When marked, these products are suitable for use in "Class I, Division 2, Groups A, B, C, D"; Class I, Zone 2, Group IIC, Class II, Division II, Groups F, G; Class III hazardous locations and nonhazardous locations only. Each product is supplied with markings on the rating nameplate indicating the hazardous location temperature code. When combining products within a system, the most adverse temperature code (lowest "T" number) may be used to help determine the overall temperature code of the system. Combinations of equipment in your system are subject to investigation by the local Authority Having Jurisdiction at the time of installation.</p>	<p>Lorsqu'ils sont marqués, ces produits ne conviennent qu'à une utilisation en environnements Classe I, Division 2, Groupes A, B, C et D ; Classe I, Zone 2, Groupe IIC, Classe II, Division II, Groupes F et G ; Classe III, dangereux ou non dangereux. Chaque produit est livré avec des marquages sur sa plaque d'identification qui indiquent le code de température pour les environnements dangereux. Lorsque plusieurs produits sont combinés dans un système, le code de température le plus défavorable (code " T " le plus faible) peut être utilisé pour déterminer le code de température global du système. Les combinaisons d'équipements dans le système sont sujettes à inspection par les autorités locales qualifiées au moment de l'installation.</p>
<div style="display: flex; align-items: center;">  <div> <p><b>WARNING: EXPLOSION HAZARD</b></p> <ul style="list-style-type: none"> <li>• Do not disconnect equipment unless power has been removed or the area is known to be nonhazardous.</li> <li>• Do not disconnect connections to this equipment unless power has been removed or the area is known to be nonhazardous.</li> <li>• Substitution of components may impair suitability for Class I, Division 2.</li> <li>• Peripheral equipment must be suitable for the location in which it is used.</li> <li>• The battery or real-time clock module in this product must only be changed in an area known to be nonhazardous.</li> <li>• All wiring must be in accordance with Class I, Division 2, Class II, Division 2, or Class III, Division 2 wiring methods of Articles 501, 502 or 503, as appropriate, of the National Electrical Code and/or in accordance with Section 18-1J2 of the Canadian Electrical Code, and in accordance with the authority having jurisdiction.</li> </ul> </div> </div>	<div style="display: flex; align-items: center;">  <div> <p><b>AVERTISSEMENT : RISQUE D'EXPLOSION</b></p> <ul style="list-style-type: none"> <li>• Couper le courant ou s'assurer que l'environnement est classé non dangereux avant de débrancher l'équipement.</li> <li>• Couper le courant ou s'assurer que l'environnement est classé non dangereux avant de débrancher les connecteurs.</li> <li>• La substitution de composants peut rendre cet équipement inadapté à une utilisation en environnement de Classe I, Division 2</li> <li>• Les équipements périphériques doivent s'adapter à l'environnement dans lequel ils sont utilisés.</li> <li>• La batterie ou le module de l'horloge en temps réel de ce produit doit être changé(e) uniquement dans un environnement classé sans risque.</li> <li>• Tous les systèmes de câblage doivent être de Classe I, Division 2, Classe II, Division 2, ou Classe III, Division 2, conformément aux méthodes de câblage indiquées dans les Articles 501, 502 ou 503 du National Electrical Code (Code Electrique National) et/ou conformément à la Section 18-1J2 du Canadian Electrical Code (Code Electrique Canadien), et en fonction de l'autorité de juridiction.</li> </ul> </div> </div>

**Table 29 - Temperature Codes - PanelView Plus 6 Terminals**

Terminal Model	Input Power	Temperature Code	Description
400 and 600 terminals	DC	T4	Do not install terminals rated T4 in environments where atmospheric gases have ignition temperatures less than 135 °C (275 °F).
	AC	T4	
700 to 1500 terminals	DC	T4	Do not install terminals rated T3 in environments where atmospheric gases have ignition temperatures less than 200 °C (392 °F).
	AC	T3	

## Required Circuit Parameters for USB Peripheral Devices

The terminals contain one or two USB host ports that comply with hazardous location environments. Field-wiring compliance requirements are provided in compliance with the National Electrical Code, Article 500.

**Figure 4 - PanelView Plus 6 Terminals Control Drawing**

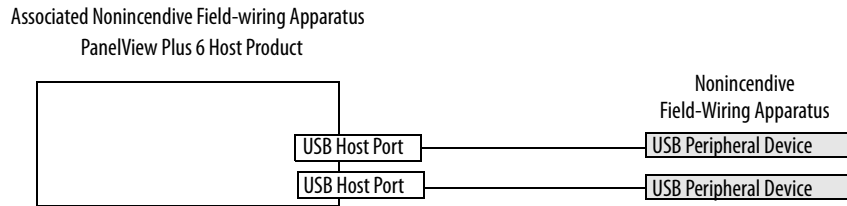

PanelView™ Plus 6 terminals provide one or two separately-powered USB host ports. [Table 30](#) defines the circuit parameters of the USB host ports.

**Table 30 - Circuit Parameters for USB Host Ports**

Parameter	Value	Parameter Definition	
$V_{oc(USB)}$	5.25V DC	Open circuit voltage of the host USB port. The maximum applied voltage rating, $V_{max(Peripheral)}$ , of the USB peripheral device must be greater than or equal to $V_{oc(USB)}$ .	$V_{max(Peripheral)} \geq V_{oc(USB)}$ , as appropriate
$I_{sc(USB)}$	1.68 A	Maximum output current of the host USB port. The maximum current, $I_{max(Peripheral)}$ , to which each USB peripheral device can be subjected must be greater than or equal to $I_{sc(USB)}$ .	$I_{max(Peripheral)} \geq I_{sc(USB)}$
$C_{a(USB)}$	10 $\mu$ F	This value is the maximum total capacitance that can be connected to the USB host port. The total capacitance of the USB peripheral device and its associated cable must not exceed the indicated value. The maximum total capacitance, $C_{i(Peripheral)}$ , and cable capacitance of the separate USB peripheral device must be less than or equal to $C_{a(USB)}$ .	$C_{i(Peripheral)} + C_{cable(USB)} \leq C_{a(USB)}$
$L_{a(USB)}$	15 $\mu$ H	This value is the maximum total inductance that can be connected to the USB host port. The total inductance of the USB peripheral device and its associated cable must not exceed the indicated value. The maximum total inductance, $L_{i(Peripheral)}$ , and cable inductance of the separate USB peripheral device must be less than or equal to $L_{a(USB)}$ .	$L_{i(Peripheral)} + L_{cable} \leq L_{a(USB)}$

### Application Information

Per the National Electrical Code, the circuit parameters of associated field-wiring apparatus for use in hazardous locations must be coordinated with the host product such that their combination remains nonincendive. PanelView Plus 6 terminals and the USB peripheral devices must be treated in this manner.

The USB peripheral devices and their associated cabling must have circuit parameters with the limits given in [Table 30](#) for them to remain nonincendive when used with the PanelView Plus 6 USB host port.

If cable capacitance and inductance are not known, use the following values from ANSI/ISA-RP 12.06.01-2003:

$$C_{cable} = 197 \text{ pF/m (60 pF/ft)}$$

$$L_{cable} = 0.7 \text{ } \mu\text{H/m (0.20 } \mu\text{H/ft)}$$

Nonincendive field-wiring must be wired and separated in accordance with 501.10(B)(3) of the National Electrical Code (NEC) ANSI/NFPA 70 or other local codes as applicable. This associated nonincendive field-wiring apparatus has not been evaluated for use in combination with another associated nonincendive field-wiring apparatus.

## Mounting Clearances

Plan for adequate space around the terminal, inside the enclosure, for ventilation and connections. Consider heat produced by other devices in the enclosure. The ambient temperature around the terminal must be 0...55 °C (32...131 °F).

**Table 31 - Minimum Required Clearances**

Product Area	Minimum Clearance
Top	51 mm (2 in.)
Bottom	102 mm (4 in.)
Side	25 mm (1 in.)
Back	0 mm (0 in.)

A clearance of 102 mm (4 in.) is sufficient on the side of the terminal to insert and remove an SD card, and on the bottom of terminal for connections.

## Panel Guidelines

The terminals are panel-mounted devices intended to mount in the door or wall of a NEMA rated, UL Type rated, or IP rated enclosure:

- Supporting panels must have a mounting thickness of 1.5...4.8 mm (0.060...0.188 in.).
- The material strength and stiffness of the panel must be sufficient to hold the terminal and maintain an appropriate seal against water and dust.
- The panel surface must be flat and free of imperfections to maintain an adequate seal and NEMA and UL Type ratings.

## Panel Cutout Dimensions

Use the full size template shipped with your terminal to mark the panel cutout dimensions.

**Table 32 - Panel Cutout Dimensions**

Terminal	Input Type	Height, mm (in.)	Width, mm (in.)
400	Keypad or keypad/touch	123 (4.86)	156 (6.15)
600	Keypad or keypad/touch	142 (5.61)	241 (9.50)
	Touch	123 (4.86)	156 (6.15)
700	Keypad or keypad/touch	167 (6.57)	264 (10.39)
	Touch	154 (6.08)	220 (8.67)
1000	Keypad or keypad/touch	224 (8.8)	375 (14.75)
	Touch	224 (8.8)	305 (12.00)
1250	Keypad or keypad/touch	257 (10.11)	390 (15.35)
	Touch <sup>(1)</sup>	257 (10.11)	338 (13.29)
1500	Keypad or keypad/touch	305 (12.00)	419 (16.50)
	Touch	305 (12.00)	391 (15.40)

(1) Also applies to high-bright display module, cat. no. 2711P-RDT12H.

## Product Dimensions

Table 33 and Table 34 provide product dimensions for all PanelView Plus 6 terminals.

Figure 5 - PanelView Plus 6 - 400 Keypad or Keypad/Touch

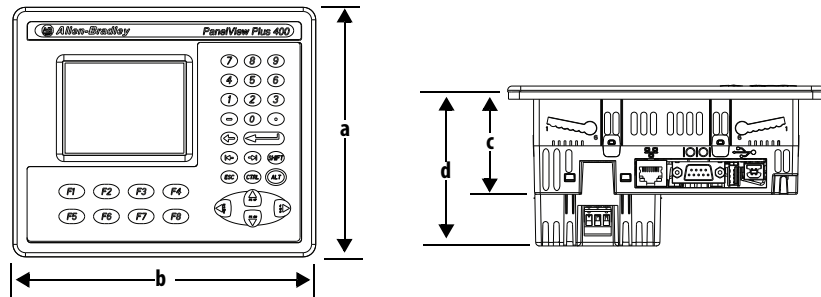

Figure 6 - PanelView Plus 6 - 600 Touch

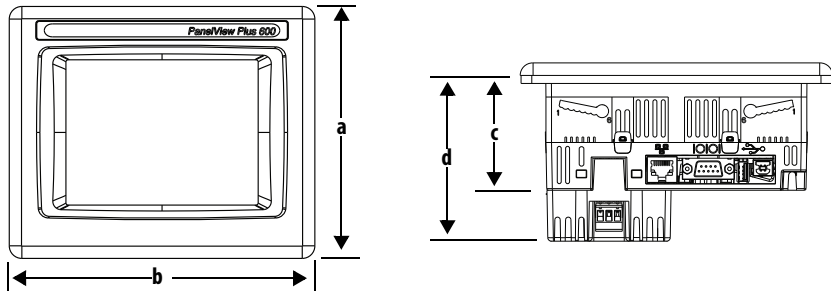

Figure 7 - PanelView Plus 6 - 600 Keypad or Keypad/Touch

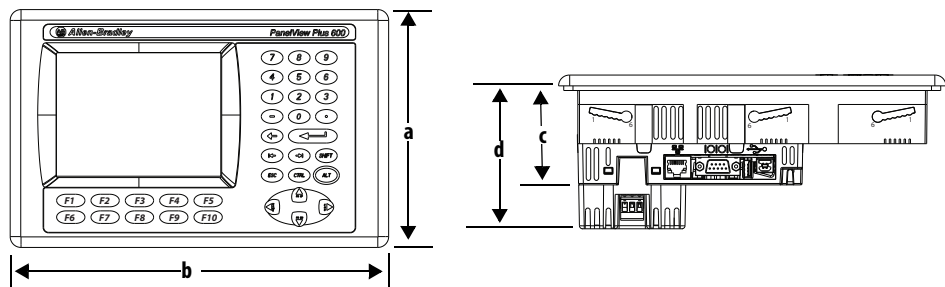

Table 33 - PanelView Plus 6 - 400 and 600 Product Dimensions

Terminal	Input Type	Height (a) mm (in.)	Width (b) mm (in.)	Depth (c) mm (in.)	Depth (d) with AC module mm (in.)
400	Keypad or keypad/touch	152 (6.0)	185 (7.28)	60 (2.35)	90 (3.54)
600	Keypad or keypad/touch	167 (6.58)	266 (10.47)	68 (2.68)	98 (3.86)
	Touch	152 (6.0)	185 (7.28)	68 (2.68)	98 (3.86)

The 700 to 1500 terminals look similar. The 1000 keypad and keypad/touch terminals are shown for illustrative purposes.

Figure 8 - PanelView Plus 6 - 1000 Keypad, Keypad/Touch, Touch

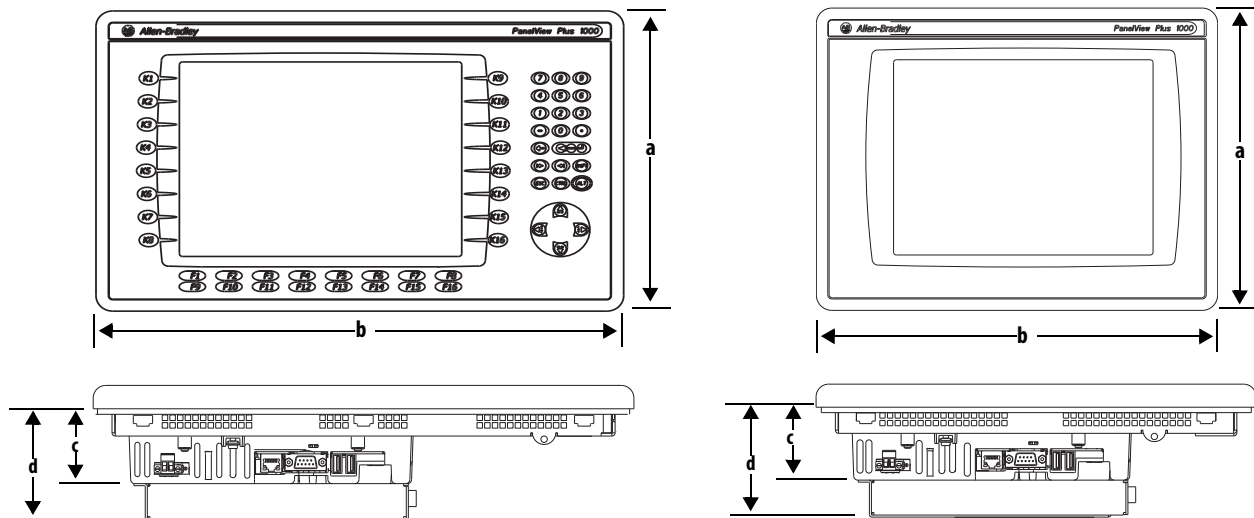

Table 34 - PanelView Plus 6 - 700 to 1500 Terminal Dimensions

Terminal	Input Type	Height (a) mm (in.)	Width (b) mm (in.)	Depth (c) Display to Logic Module mm (in.)	Depth (d) Display to Comm Module mm (in.)
700	Keypad or keypad/touch	193 (7.58)	290 (11.40)	55 (2.18)	83 (3.27)
	Touch	179 (7.04)	246 (9.68)	55 (2.18)	83 (3.27)
1000	Keypad or keypad/touch	248 (9.77)	399 (15.72)	55 (2.18)	83 (3.27)
	Touch	248 (9.77)	329 (12.97)	55 (2.18)	83 (3.27)
1250	Keypad or keypad/touch	282 (11.12)	416 (16.36)	55 (2.18)	83 (3.27)
	Touch	282 (11.12)	363 (14.30)	55 (2.18)	83 (3.27)
	Touch (high-bright module)	282 (11.12)	363 (14.30)	74 (2.9)	101 (3.99)
1500	Keypad or keypad/touch	330 (12.97)	469 (18.46)	65 (2.55)	93 (3.65)
	Touch	330 (12.97)	416 (16.37)	65 (2.55)	93 (3.65)

## Mount the 400/600 Terminal in a Panel

The terminals were designed for single-person installation. No tools are required except for those needed to make the panel cutout

Mounting levers secure the terminal to the panel. Four or six levers are required depending on the terminal model. The levers insert into the mounting slots on the top and bottom of the terminal.

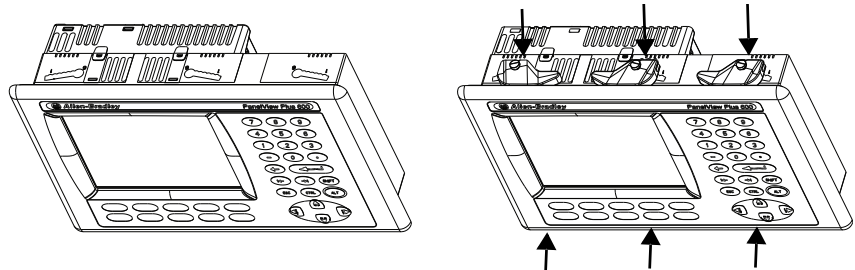

Each mounting slot has six notches with alignment marks that are locking positions for a lever. The thickness of the panel in which you mount the terminal determines the locking position required to maintain the NEMA/UL Type seal.

**Table 35 - Lever Locking Positions**

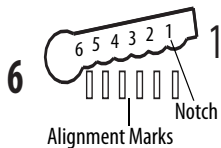
Mounting Slot	Lever Lock Position	Panel Thickness Range	Typical Gauge
Orientation of Slot Varies  	1	1.50...2.01 mm (0.060...0.079 in.)	16
	2	2.03...2.64 mm (0.080...0.104 in.)	14
	3	2.67...3.15 mm (0.105...0.124 in.)	12
	4	3.17...3.66 mm (0.125...0.144 in.)	10
	5	3.68...4.16 mm (0.145...0.164 in.)	8/9
	6	4.19...4.80 mm (0.165...0.188 in.)	7

Follows these steps to mount the terminal in a panel.



**ATTENTION:**

Disconnect all electrical power from the panel before making the panel cutout. Make sure the area around the panel cutout is clear and that the panel is clean of any debris, oil, or other chemicals. Make sure metal cuttings do not enter any components already installed in the panel and that the edges of the cutout have no burrs or sharp edges. Failure to follow these warnings can result in personal injury or damage to panel components.

1. Cut an opening in the panel by using the cutout template shipped with the terminal or the cutout dimensions on [page 28](#).
2. Verify the sealing gasket is present on the terminal.

This gasket forms a compression type seal. Do not use sealing compounds.

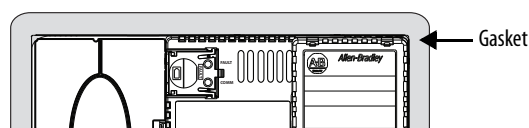

- Place the terminal in the panel cutout.

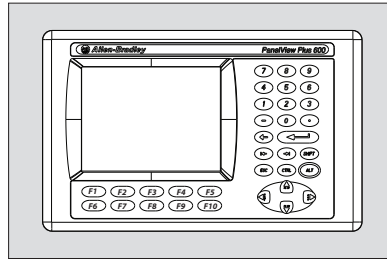

- Insert all mounting levers into the mounting slots on the terminal.  
Slide each lever until the flat side of the lever touches the panel surface.

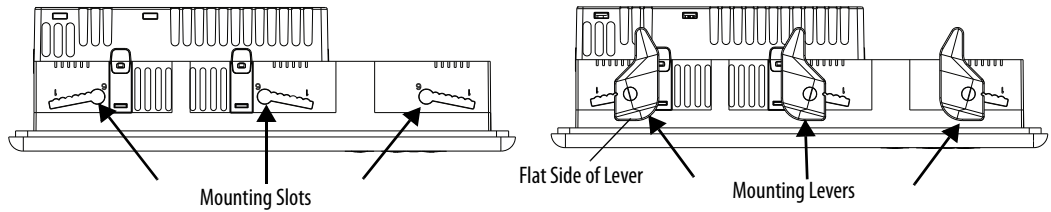

- When all levers are in place, slide each lever an additional notch or two until you hear a click.  
Refer to [Table 35 on page 31](#) as a guide to determine the locking positions for your panel thickness.
- Rotate each lever in direction indicated until it is in the final position.

**TIP** Levers rotate in same direction on top and bottom of terminal.

Follow the appropriate locking sequence for the optimal terminal fit.

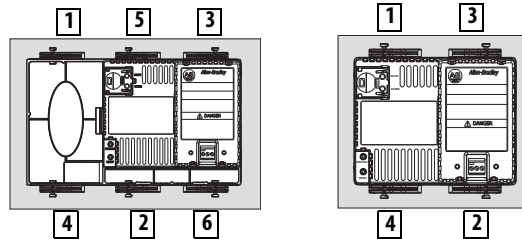
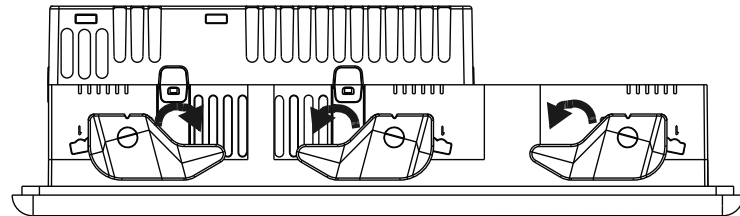
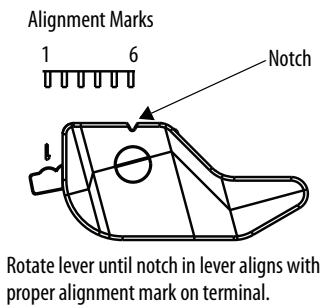

- Inspect all levers to verify they are in the correct and same locked position.



**ATTENTION:** All levers must be locked to provide an adequate gasket seal between the terminal and the panel. Rockwell Automation assumes no responsibility for water or chemical damage to the terminal or other equipment within the enclosure because of improper installation.



## Mount the 700 to 1500 Terminal in a Panel

Mounting clips secure the 700 to 1500 terminals in a panel. The number of clips varies by terminal size. Tools required for installation include panel cutout tools, a small, slotted screwdriver, and a torque wrench for tightening the mounting clips.

**ATTENTION:**

Disconnect all electrical power from the panel before making the panel cutout. Make sure the area around the panel cutout is clear and that the panel is clean of any debris, oil, or other chemicals. Make sure metal cuttings do not enter any components already installed in the panel and that the edges of the cutout have no burrs or sharp edges. Failure to follow these warnings can result in personal injury or damage to panel components.

---

**IMPORTANT** For outdoor installations using a high-bright display module, catalog number 2711P-RDT12H, refer to Appendix B on [page 177](#) for important installation considerations.

---

Follow these steps to mount the terminal in a panel.

1. Cut an opening in the panel by using the panel cutout template shipped with the terminal or the cutout dimensions on [page 28](#).
2. Verify the terminal sealing gasket is properly positioned on the terminal. This gasket forms a compression type seal. Do not use sealing compounds.

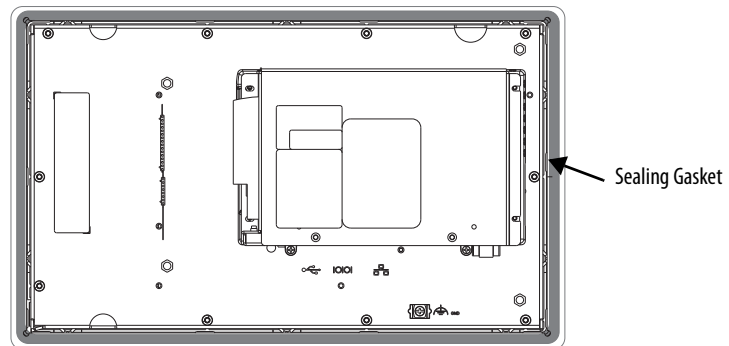

Be careful not to pinch the legend strip during installation.

- Place the terminal in the panel cutout.

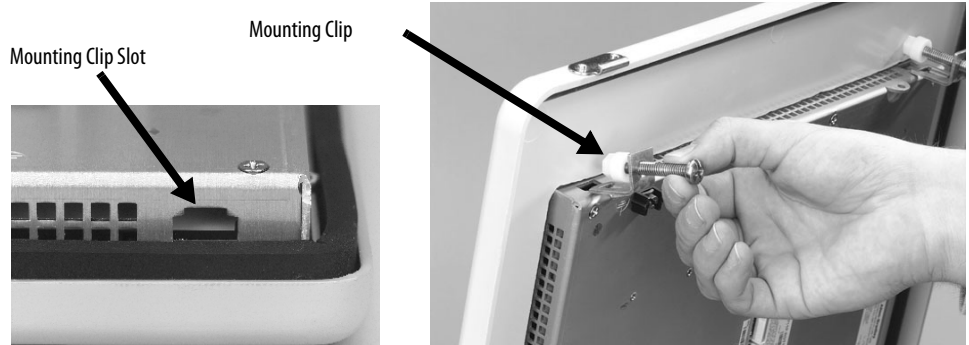

- Slide the ends of the mounting clips into the slots on the terminal.
- Tighten the mounting clip screws by hand until the gasket seal contacts the mounting surface uniformly.



- Tighten the mounting clips screws to a torque of 0.90...1.1 N•m (8...10 lb•in) by using the specified sequence, making sure not to overtighten.

1	4
Torque Sequence 4 Clips	
3	2

1	5	3
Torque Sequence 6 Clips		
4	2	6

1	6
Torque Sequence 8 Clips	
3	8
7	4
5	2



**ATTENTION:** Tighten the mounting clips to the specified torque to provide a proper seal and to prevent damage to the product. Allen-Bradley assumes no responsibility for water or chemical damage to the product or other equipment within the enclosure because of improper installation. Any contamination of the product caused by improper installation is not warranted.

## Remove and Install the Power Terminal Block

The terminals are shipped with a power terminal block installed. You can remove the terminal block for ease of installation, wiring, and maintenance.



### **WARNING:** Explosion Hazard

If you connect or disconnect wiring while the power is on, an electrical arc can occur. This could cause an explosion in hazardous location installations. Be sure that power is removed and the area is nonhazardous before proceeding.

Failure to remove power can result in electrical shock or damage to the terminal.

The terminal blocks have different colors and markings for AC and DC power connections. Always match the terminal block color to its mating connector. The power terminal blocks are not intended for daisy chaining power.

Use a 0.6 x 3.5 mm flat blade screwdriver for terminal block wiring.

**Table 36 - Wire Specifications for Power Input Terminal Block**

Terminal	Wire Type	Dual-wire Size <sup>(1)</sup>	Single-wire Size	Strip Length	Screw Torque
400, 600	Stranded or solid Cu 90 °C (194 °F)	0.3...1.3 mm <sup>2</sup> 22...16 AWG	0.3...2.1 mm <sup>2</sup> (22...14 AWG)	7 mm (0.28 in.)	0.45...0.56 N•m (4...5 lb•in)
700 to 1500					0.56...0.90 N•m (5...8 lb•in)

(1) Two-wire max per terminal.

### 400 and 600 Terminals

Follow these steps to remove the terminal block from a 400 or 600 terminal.

1. Insert the tip of a small, flat-blade screwdriver into the terminal block access slot.
2. Gently pry the terminal block to rotate it away from the terminal; this releases the locking mechanism.

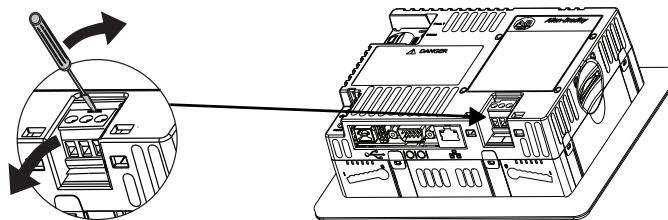

Follow these steps to replace the terminal block.

1. Press terminal block base in first with block leaning outward.

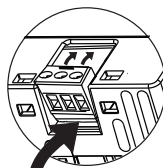

2. Gently push the top of the terminal block to rotate it into place; it snaps when seated.

## 700 to 1500 Terminals

Follow these steps to remove the terminal block from a 700 to 1500 terminal.

1. Loosen the two screws that secure the terminal block.
2. Gently pull the terminal block away from the connector.

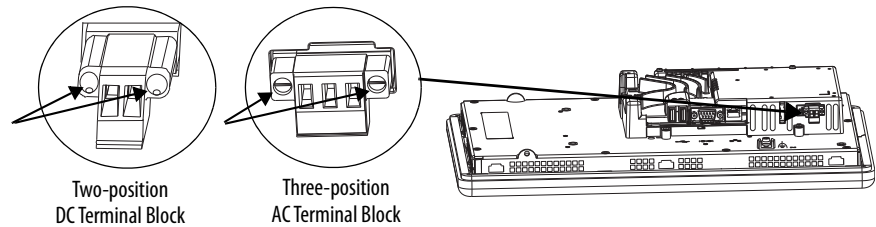

Follow these steps to install the terminal block.

1. Reattach the terminal block to the connector until seated.
2. Tighten the two screws that secure the terminal block to a torque of 0.40...0.51 N•m (3.5...4.5 lb•in).

## DC Power Connections

Terminals with an integrated 24V DC power supply have these power ratings.

**Table 37 - DC Power Ratings**

Terminal	Power Supply	Input Voltage	Power Consumption
400, 600	Nonisolated	24V DC nom (18...30V DC)	15 W max (0.6 A at 24V DC)
700 to 1500	Isolated	24V DC nom (18...32V DC)	70 W max (2.9 A at 24V DC)

The power supply is internally protected against reverse polarity. Connecting DC+ or DC- to the earth/ground terminal can damage the device.



**ATTENTION:** Applying an AC power source to a terminal with a DC power input can damage the device.



**ATTENTION:** Proper Input Voltage must be applied at all times. Voltage Spikes or power quality issues that cause the voltage to go outside of the proper input range may cause damage to the device; this condition is not warranted by Rockwell Automation.

## External Power Supply

The 400 and 600 terminals require a dedicated 24V DC Class 2 power supply or a safety extra-low voltage (SELV) or protective extra-low voltage (PELV) power supply to power each PanelView Plus 6 400 and 600 device.

For the 700 - 1500 terminals, it is recommended that a dedicated 24V DC safety extra-low voltage (SELV) or protective extra-low voltage (PELV) power supply is used to power each PanelView Plus 6 700 - 1500 device.



**ATTENTION:** Use a SELV or PELV power supply as required by local wiring codes for your installation. These power supplies provide protection so that under normal and single fault conditions, the voltage between conductors and earth ground does not exceed a safe value.

**TIP** Terminals with an isolated DC power supply can be powered by the same power source as other equipment, such as a DC power bus.

PanelView Plus 6 devices were tested to operate with the catalog number 1606-XLE120E power supply. To use another power supply, review the criteria in the table.

**Table 38 - Power Supply Criteria**

If the PanelView Plus 6 Device	Use a	Description
Connects to equipment with isolated communication ports	SELV or PELV power supply	Other equipment can share this power supply with the PanelView Plus 6 device provided that no ground loops are created. A PELV source internally connects the negative power terminal to chassis ground.
Does not connect to other equipment		
Connects to equipment with non-isolated communication ports	Dedicated, isolated, and ungrounded SELV source to power each terminal	This prevents ground loops from damaging the device.

**IMPORTANT** All of the communication ports on the terminals and supported communication modules are isolated, with the exception of the USB ports.

## Earth/Ground Connection



PanelView Plus 6 devices with a DC power input have an earth/ground terminal that you must connect to a low-impedance earth/ground.

- On 400 and 600 terminals, the earth/ground connection is on the power terminal block.
- On 700 to 1500 terminals, the earth/ground connection is on the rear of the display module.

**IMPORTANT** The earth/ground connection to ground is mandatory. This connection is required for the following:

- Noise immunity, reliability, and Electromagnetic Compliance (EMC) with the European Union (EU) EMC directive for CE-mark conformance
- Safety by Underwriters Laboratory

**Table 39 - Earth Wire Specifications for DC Power**

Terminal	Symbol	Wire Type	Wire Gauge	Terminal Screw Torque
400, 600	 GND	Stranded or solid Cu 90 °C (194 °F)	2.1...3.3 mm <sup>2</sup> (14...12 AWG)	0.45...0.56 N·m (4...5 lb·in)
700 to 1500	 GND	Stranded or solid Cu 90 °C (194 °F)	2.1...5.3 mm <sup>2</sup> (14...10 AWG)	1.13...1.36 N·m (10...12 lb·in)



**ATTENTION:** Damage or malfunction can occur when a voltage potential exists between two separate ground points. Make sure the terminal does not serve as a conductive path between ground points at different potentials.

### Connect DC Power



**WARNING:** Explosion Hazard  
Do not disconnect equipment unless power has been switched off and area is known to be nonhazardous.  
Disconnect all power before installing or replacing components. Failure to disconnect power can result in electrical shock or damage to the terminal.

Follow these steps to connect the terminal to DC power.

1. Verify that the terminal is not connected to a power source.
2. Strip 7 mm (0.28 in.) of insulation from the ends of the wires.

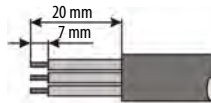

3. Secure the DC power wires to the marked terminals (+ and -) on the power terminal block.
4. Secure the earth/ground wire.
  - On 400 and 600 terminals, secure the earth/ground wire to the functional earth/ground terminal on the power terminal block.
  - On 700 to 1500 terminals, secure the earth/ground wire to the functional earth screw on the back of the display.

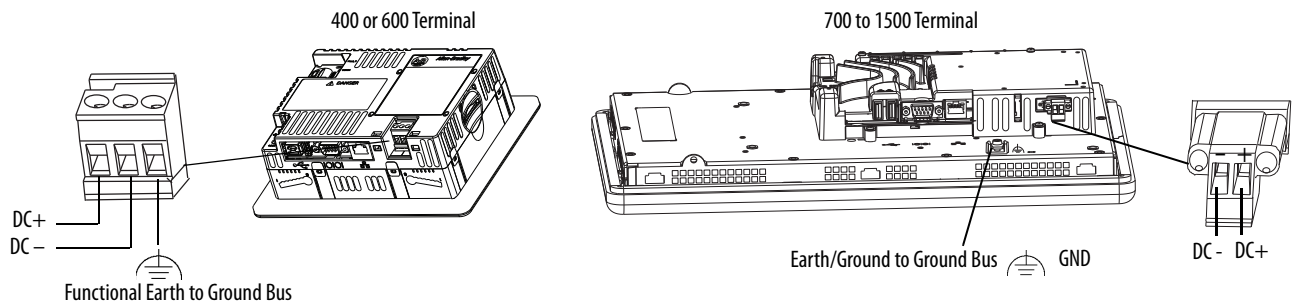

5. Apply power to the terminal.

## AC Power Connections

Terminals with an integrated AC power supply have these power ratings.

**Table 40 - AC Power Ratings**

Terminal	Input Voltage	Power Consumption
400, 600	100...240V AC (50...60 Hz)	35VA max
700, 1000, 1250, 1500	100...240V AC (50...60 Hz)	160VA max

## Protective Earth and Functional Earth Connections

PanelView Plus 6 devices with an AC power input have a protective earth terminal you must connect to a low-impedance earth ground. The protective earth terminal is on the power input terminal block.

**IMPORTANT** In addition to the protective earth connection, the 700 and 1500 terminals also have a functional earth terminal that you must connect to a low-impedance earth ground. The functional earth connection is on the back of the display.



**ATTENTION:** The protective earth and functional earth connections to ground are mandatory.

- The functional earth is required for Electromagnetic compliance (EMC) with the European Union (EU) EMC directive for CE-mark conformance.
- The protective earth is required for both safety and regulatory compliance.

**Table 41 - Protective Earth/Functional Earth Wire Specifications for AC Power**

Earth Connections		Wire Type		Wire Gauge	Terminal Screw Torque
Protective earth 400, 600		Stranded or solid	Cu 90 °C (194 °F)	2.1...3.3 mm <sup>2</sup> (14...12 AWG)	0.45...0.56 N·m (4...5 lb·in)
Protective earth 700 to 1500		Stranded or solid	Cu 90 °C (194 °F)	2.1...3.3 mm <sup>2</sup> (14...12 AWG)	0.56...0.90 N·m (5...8 lb·in)
Functional earth 700 to 1500 only	GND	Stranded or solid	Cu 90 °C (194 °F)	2.1...5.3 mm <sup>2</sup> (14...10 AWG)	1.13...1.36 N·m (10...12 lb·in)

## Connect AC Power



**WARNING:** Explosion Hazard

Do not disconnect equipment unless power has been switched off and area is known to be nonhazardous.

Disconnect all power before installing or replacing components. Failure to disconnect power can result in electrical shock or damage to the terminal.



**ATTENTION:** Improper wiring of the power terminals can result in voltage at the communication connector shells.

Do not apply power to the terminal until all wiring is connected. Failure to do so can result in electrical shock.

Follow these steps to connect the terminal to AC power.

1. Verify that the terminal is not connected to a power source.
2. Strip 7 mm (0.28 in.) of insulation from the ends of the wires.

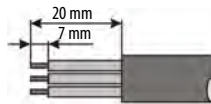

3. Secure the AC power wires to the marked terminals (L1 and L2N) on the power terminal block.
4. Secure the protective earth/ground wire to the marked position on the power terminal block.
5. On 700 to 1500 terminals, also secure the functional earth/ground wire to the functional earth screw on the back of display to ground bus.

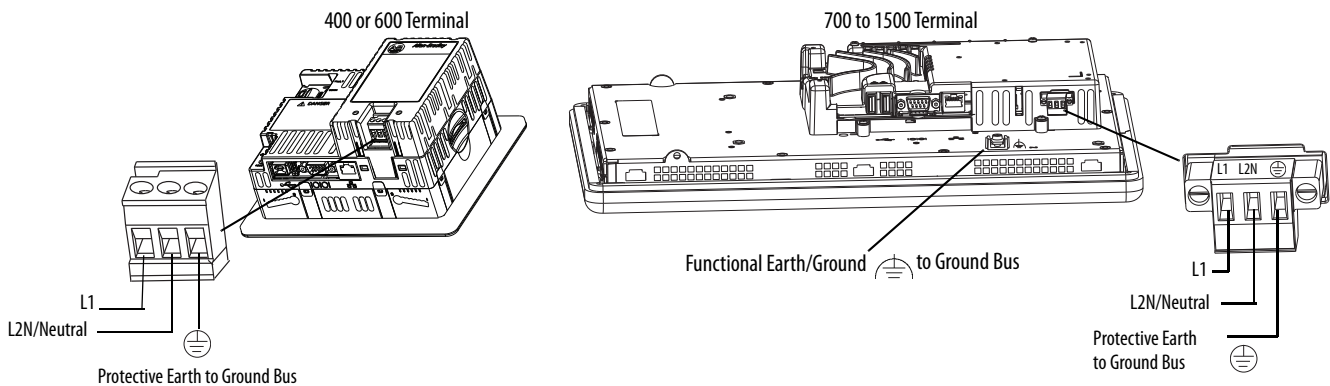

6. Apply power to the terminal.



## Initial Startup

The first time you start the system, the terminal goes through its power-up sequence and launches FactoryTalk® View ME Station Configuration mode.

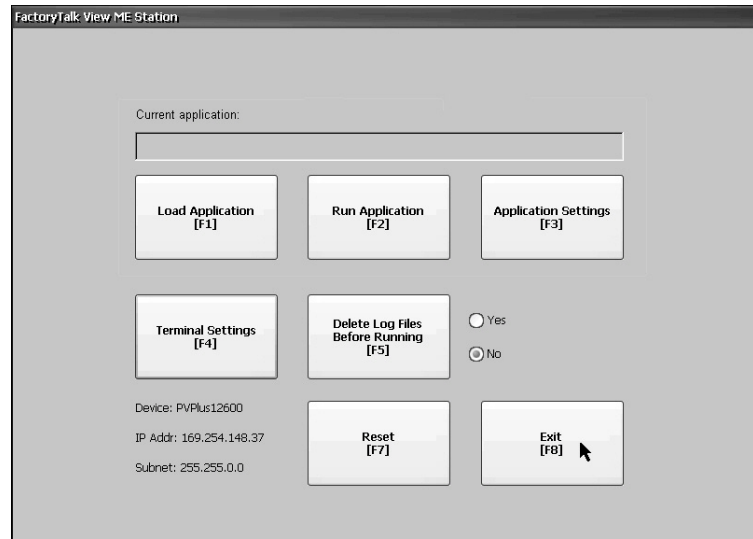

You can change the action the terminal takes on startup by pressing Terminal Settings then choosing Startup Options. You can configure one of these options:

- Launch a FactoryTalk Machine Edition HMI application that is configured to run at startup.
- Launch FactoryTalk View Machine Station Configuration mode and run the configuration options for the terminal (default).
- Launch the Windows Explorer desktop.

You can also configure a terminal to allow desktop access. Terminals are initially shipped with desktop access disabled. To allow or restrict desktop access, press Terminal Settings then choose Desktop Access.

For more information on changing the start-up option and restricting or allowing desktop access, refer to [Chapter 3 - Configuration Mode](#).

## Reset the Terminal

You have several options for restarting the terminal without having to disconnect and reapply power:

- Use the Reset switch on the back of the terminal.
- From the terminal desktop Start menu, choose Restart System.
- On the FactoryTalk View ME Station configuration dialog box, press Reset.

After a restart, the terminal performs a series of start-up tests then takes one of these actions:

- Launches an HMI application that is configured to run at startup.
- Launches FactoryTalk Machine Edition Configuration mode.
- Launches the Windows Explorer desktop.

The action that occurs depends on the start-up options configured for your terminal. Refer to [Start-up Options on page 49](#) for details.

Refer to [Start-up Messages and Codes on page 164](#) for a list of start-up information and error messages.

Follow these steps to restart the system by using the Reset switch.

1. Insert a thin, nonconductive probe into the Reset area.
2. Press the switch.



**ATTENTION:** Use a nonconductive object to press the reset switch. Don't use a conducting object such as a paper clip or the tip of a pencil. Either of these can damage the terminal.

**Figure 9 - Reset Switch**

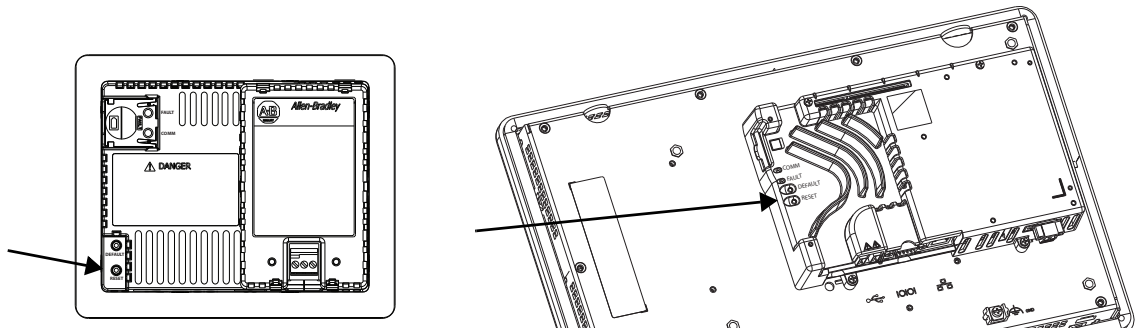

Follow these steps to restart the system from the Windows desktop.

1. From the Start menu, choose Programs>Restart System.  
You are asked to confirm the restart.
2. Click Yes to restart the terminal or No to cancel.

Follow these steps to restart the system from FactoryTalk View ME Station software.

1. Access Configuration Mode.  
Refer to [Access Configuration Mode on page 43](#) for ways to launch FactoryTalk View ME Station Configuration mode.
2. Press Reset [F7].

## Configuration Mode

Topic	Page	Topic	Page
Access Configuration Mode	43	Configure Print Options	70
Terminal Settings	46	Check Integrity of Application Files	72
Load and Run Application	48	Configure Diagnostics	73
Start-up Options	49	View and Clear the System Event Log	74
Desktop Access	52	System Information	74
Communication Setup	56	Enable or Disable the Alarm Display	76
Ethernet Network Connections	58	Time and Date Settings	77
File Management	62	Regional Settings	79
Display Settings	65	Font Linking	82
Input Device Settings	67		

### Access Configuration Mode

The terminal uses built-in software, FactoryTalk® View ME Station, to configure start-up options, load and run applications, access the Windows desktop, and perform other terminal operations. When you reset the terminal, one of these actions occurs, depending on the configured start-up option:

- FactoryTalk View ME Station Configuration mode is launched (closed system). This is the initial default.
- FactoryTalk View Machine Edition HMI .mer application is set to run (closed system).
- Windows Explorer desktop is launched (open system).



You can access the Configuration mode of the terminal from the Windows Explorer desktop by double-clicking the FactoryTalk View ME Station icon.

#### IMPORTANT

- To access Configuration mode from a running application, press Goto Configuration Mode. This button is added to application screens in FactoryTalk View Studio software during application development. The application stops running but is still loaded.
- Refer to [Configuration Mode Access on page 168](#) for details on how to access Configuration mode if the application does not contain a Goto Configuration Mode button.

**Figure 10 - FactoryTalk View ME Station Configuration Mode Dialog Box**

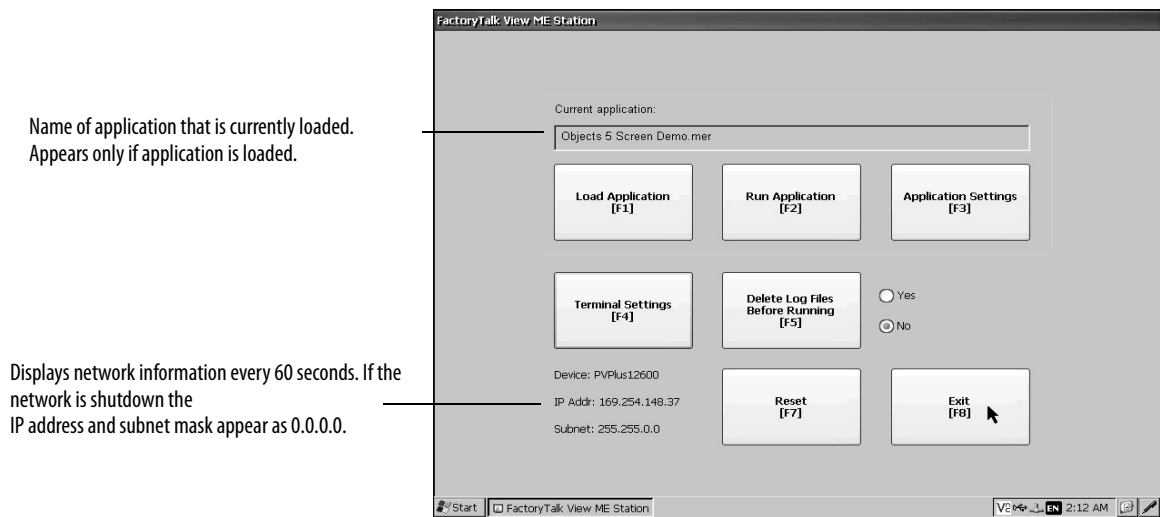

Name of application that is currently loaded. Appears only if application is loaded.

Displays network information every 60 seconds. If the network is shutdown the IP address and subnet mask appear as 0.0.0.0.

**Table 42 - Configuration Mode Operations**







Terminal Operation	Description
Load Application (F1)	Opens a dialog box where you select an application to load. The loaded application name appears under Current application.
Run Application (F2)	Runs the loaded .mer application displayed under Current application. You must load an application before running it.
Application Settings (F3)	Opens a menu of application-specific configuration settings, such as device shortcuts defined for the loaded .mer application. Device shortcuts are read-only and cannot be edited. For example, your .MER application can have CLX defined as a device shortcut name for a ControlLogix® controller.
Terminal Settings (F4)	Opens a menu of options to configure non-application, terminal settings for the PanelView™ Plus 6 device.
Delete Log Files Before Running (F5)	Toggles between Yes and No. If you select Yes, all data log files, alarm history and alarm status file are deleted before the application is run. If you select No, log files are not deleted first. Deleting log files is a way to reclaim memory in the terminal.
Reset (F7)	Resets the terminal, then launches the HMI application, configuration mode, or the desktop depending on the configured start-up option.
Exit (F8)	Exits Configuration mode. If desktop access is allowed, you can access the desktop.

*Navigation Buttons*

Many FactoryTalk View ME Station dialog boxes have data entry and navigation buttons:

- On touch-screen terminals, press the button with your finger or stylus.
- On keypad terminals, press the function key listed on the button.
- If a mouse is attached, click a button.

**Table 43 - Navigation Buttons**

Button	Description	Button	Description
	Returns to the previous dialog box. Pressing this button from the Configuration mode dialog box accesses the desktop, if allowed.	 	Moves highlight up or down a list.
 	Accepts changes and returns to previous dialog box or cancels the operation without saving changes.		Selects a highlighted function or item from a list.

## Input Panel

When you activate a data entry field, the input panel opens. If the field is restricted to a numeric value or IP address, then only the 0...9 and decimal point keys are enabled.

**Figure 11 - Input Panel**

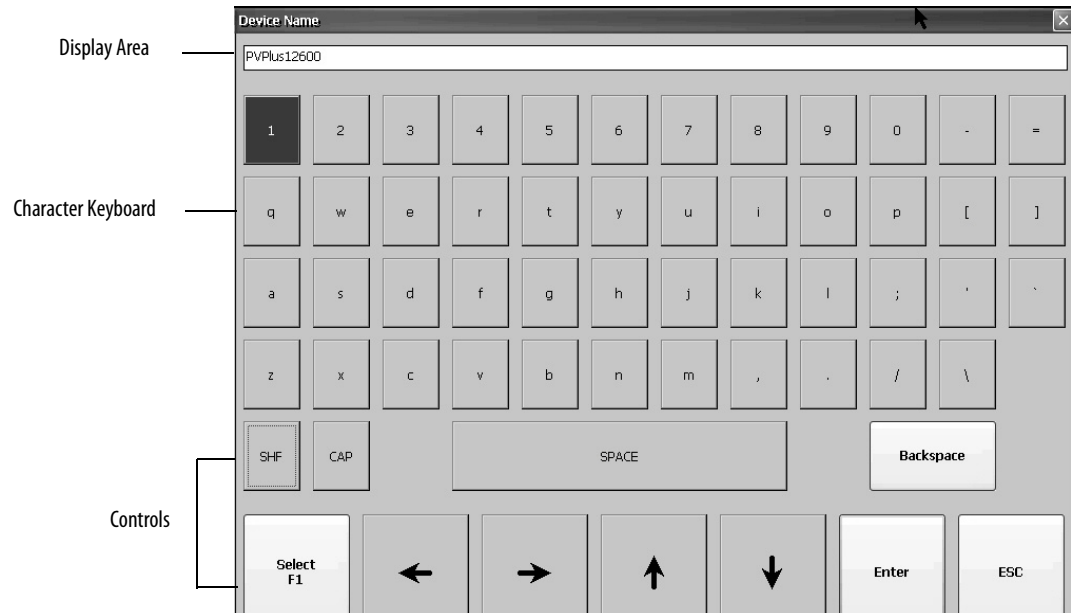

**Table 44 - Input Panel Controls**

Input Panel Controls	Function
SHF	Switches keys between their shifted and unshifted state. The initial default is unshifted.
CAP	Switches keys between lowercase and uppercase characters. The initial default is lowercase.
SPACE	Enters a space between characters in the Display Area.
Backspace	Deletes the previous character (to the left of the cursor) in the Display Area.
Select	Selects a character and enters it in the Display Area.
Left, Right, Up, Down Arrow Keys	Selects the character to the left, right, above, or below the currently selected character.
Enter	Accepts the entered characters and returns to the previous dialog box.
ESC	Cancels the current operation and returns to the previous dialog box.

Follow these steps to enter characters in the display area.

1. Select a character on the character keyboard:
  - On a touch-screen terminal, press a key.
  - On a keypad terminal, press the arrow keys on the keypad to navigate to a key.
  - If a mouse is attached, click a key.
2. Press Select to copy the character to the display area.
3. Press Enter when done to exit the input panel.

## Terminal Settings

You can modify settings on the terminal that are not specific to the application.

1. Press Terminal Settings from the FactoryTalk View ME Station Configuration mode dialog box.

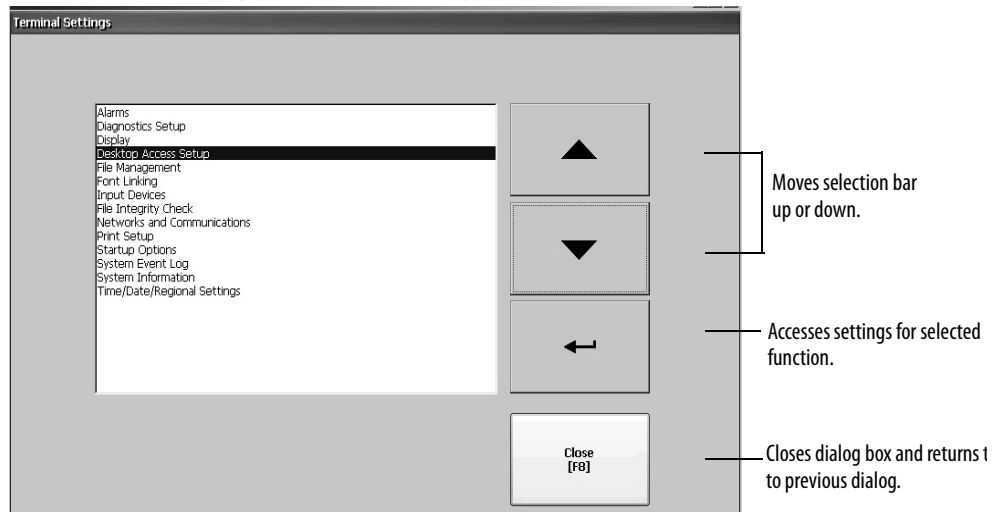

2. Select a function by using the up and down cursor buttons:
  - On touch-screen terminals, press the button.
  - On keypad terminals, press the key on the keypad or the corresponding terminal function key.
3. Press the Enter key to access selected function.

**Table 45 - Terminal Settings**

Terminal Settings	Description
Alarms	Specifies whether to close the alarm display on the terminal when the newest alarm is acknowledged by an operator. By default, the alarm display is closed.
Diagnostics Setup	Forwards diagnostic messages from a remote log destination to a computer running diagnostics.
Display	Sets the intensity of the backlight, shows the temperature of the 700 to 1500 displays, configures the screen saver, and enables the touch-screen cursor.
Desktop Access Setup	Specifies whether the desktop can be accessed with or without a password, and lets you set/reset the password.
File Management	Copies application files and font files to the terminal, an SD card or a USB flash drive. You can also delete application files from the terminal, an SD card or USB drive. Log files generated by the application can be deleted from the terminal.
Font Linking	Links a font file to a base font loaded on the terminal.
Input Devices	Configures settings for the keypad, touch screen, or attached keyboard and mouse, including touch-screen calibration. Also lets you choose between a pop-up character input or pop-up keyboard for string input.
File Integrity Check	Checks the integrity of the .mer application file and runtime files by logging details to a file integrity check log. You can view and clear this log at any time.
Networks and Communications	Configures Ethernet or other communication settings for applications.
Print Setup	Configures settings for printing displays, alarm messages, and diagnostics messages generated by the application.
Startup Options	Specifies whether the terminal launches the desktop, Configuration mode, or runs an application on startup.
System Event Log	Displays system events logged by the terminal and lets you clear events from the log.
System Information	Displays power, temperature, battery and memory details for the terminal. Also shows the firmware number for FactoryTalk View ME software and technical support information.
Time/Date/Regional Settings	Sets the date, time, language, and numeric format used by the terminal and applications.

**Figure 12 - Terminal Settings Menu Structure**

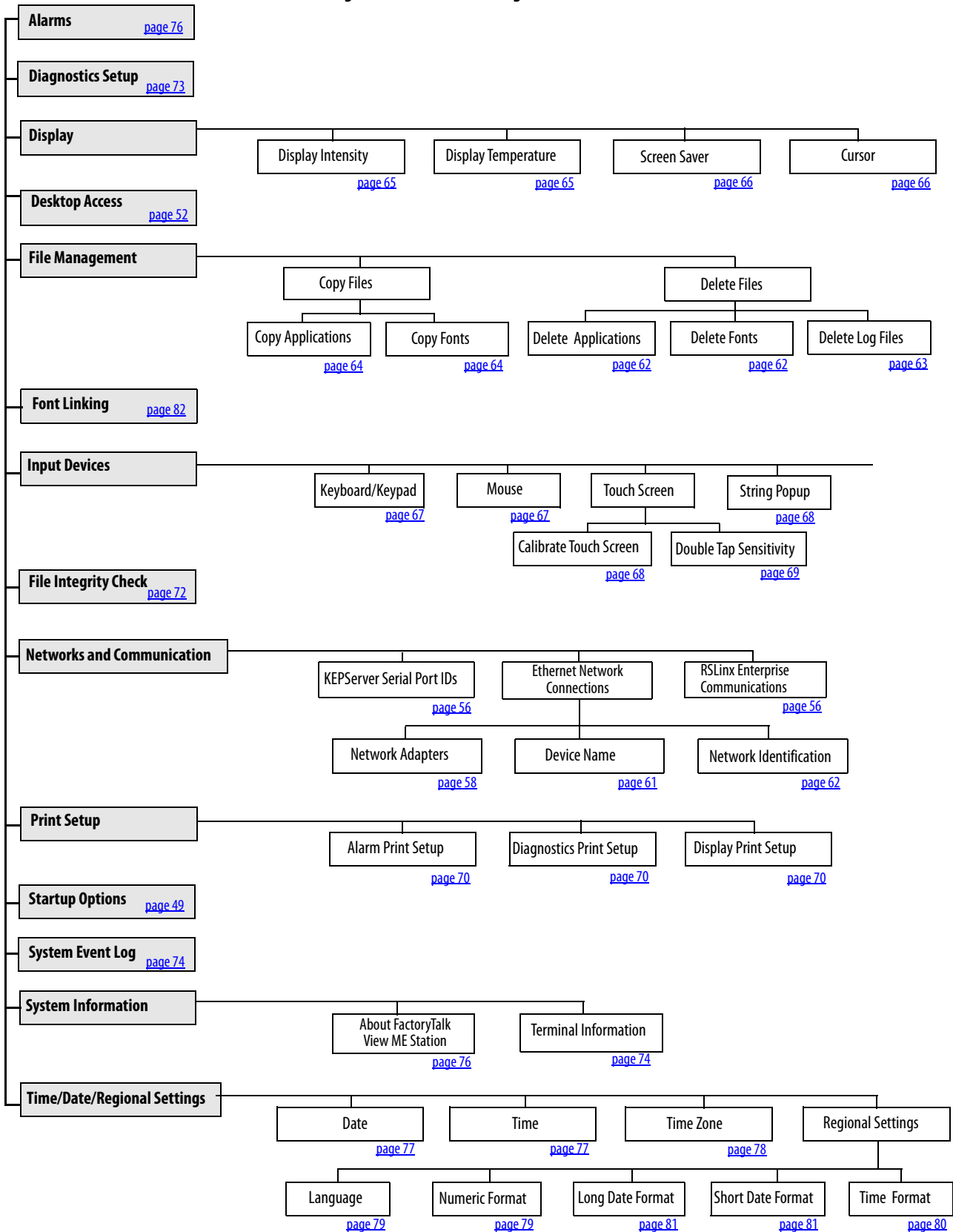

## Load and Run Application

Before running a FactoryTalk View Machine Edition .mer application, you must first load the application. You can load an .mer application from internal storage or nonvolatile memory in the terminal, an SD card, or a USB flash drive.

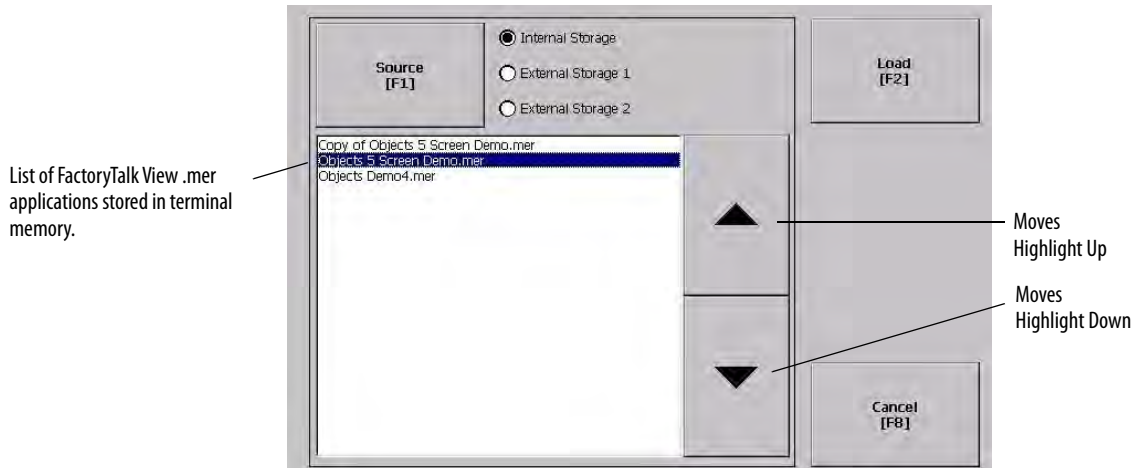

Follow these steps to load and run an application.

1. Press Load Application from the Configuration mode dialog box.
2. Press Source to select the location of the file you want to load:
  - Internal Storage - nonvolatile memory of the terminal.
  - External Storage 1 - SD card loaded in the card slot of the terminal.
  - External Storage 2 - USB flash drive connected to a USB host port.

**TIP** The recognized path for Machine Edition files on the terminal, USB flash drive, or SD card is \Application Data\Rockwell Software\RSViewME\Runtime\. On the terminal, the path is in My Device on the desktop.

3. Select an .mer file from the list by using the up and down cursor keys.
4. Press Load to load the selected application.

You are asked if you want to replace the terminal's communication configuration with the configuration in the application.

5. Select Yes or No.

If you select Yes, any changes to the device addresses or driver properties in the RSLinx® Communications dialog box are lost.

The name of the currently loaded application appears at the top of the main Configuration mode dialog box.

6. Press Run on the Configuration mode dialog box to run the loaded application.

**TIP** Applications generate log files. To delete log files before running an application, select Delete Log Files Before Running on the Configuration Mode dialog box. Deleting log files reclaims terminal memory.

**TIP** [Refer to Start-up Options on page 49](#) to set the application to automatically run on startup or a terminal reset.



## Start-up Options

You can specify what action the terminal takes on startup or a reset.

This Start-up Option	Performs This Action	Typical System
Do not start FactoryTalk View ME Station	Launches the Windows Explorer desktop on startup.	Open
Go to Configuration Mode	Launches FactoryTalk View ME Station Configuration mode on startup. This is the initial, factory default setting.	Closed
Run Current Application	Runs the FactoryTalk View ME application loaded in the terminal on startup.	Closed

**IMPORTANT** When desktop access is restricted, the start-up option must be set to Run Current Application or Go to Configuration Mode (default). Refer to [page 52](#) for details on how to enable or disable desktop access.

## Disable FactoryTalk View ME Station Software on Startup

Terminals with extended features and file viewers are typically configured to launch the Windows desktop on startup. This means you must disable FactoryTalk View ME Station from launching on startup.

**TIP** The desktop can also be launched from FactoryTalk View ME Station Configuration mode by pressing Exit.

Follow these steps to disable FactoryTalk View ME Station on startup so that the desktop can launch.

1. Press Terminal Settings>Startup Options.

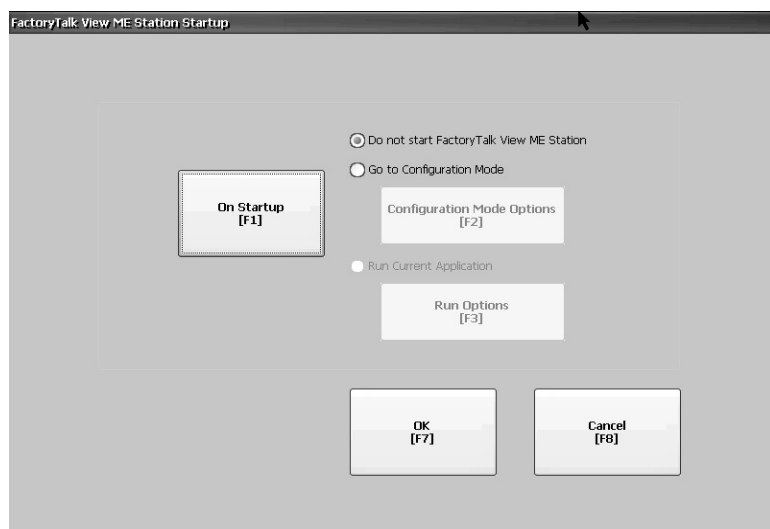

2. Press On Startup until 'Do not start FactoryTalk View ME Station' is selected.

**TIP** When disabling FactoryTalk View ME Station, desktop access must be set to allow or you get a warning. Refer to [Enable Desktop Access on page 52](#).

3. Press OK.

## Enter Configuration Mode on Startup

Follow these steps to automatically launch the FactoryTalk View ME Station Configuration mode dialog box on startup.

1. Press Terminal Settings>Startup Options.
2. Press On Startup to select Go to Configuration Mode.

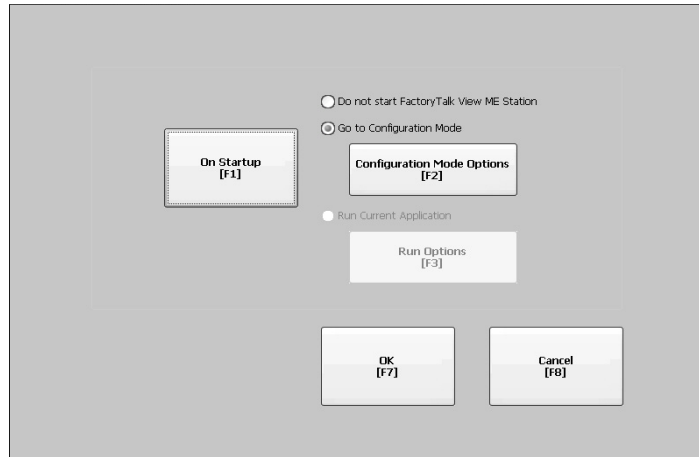

3. Press Configuration Mode Options.

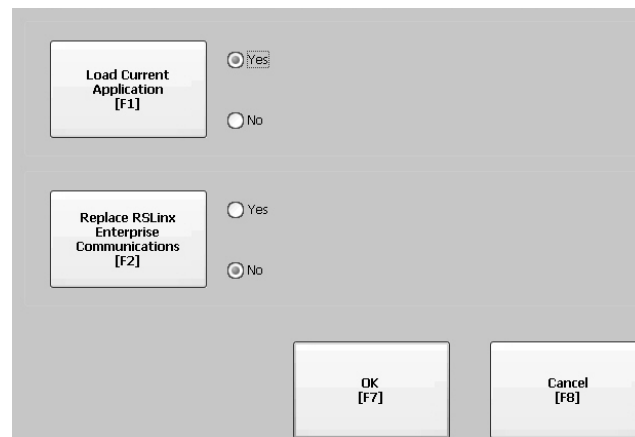

4. Press Load Current Application to specify whether you want to load the current application on startup.
5. Press Replace RSLinx Enterprise Communications to specify whether to use the communication configuration of the current application or that of the terminal on startup:
  - Select No to use the RSLinx configuration of the terminal.
  - Select Yes to use the configuration of the application. The terminal configuration is replaced with the application settings. Any changes to device addresses or driver properties in RSLinx communication are lost.
6. Press OK to return to the previous dialog box.
7. Press OK to return to Terminal Settings.

## Run the Loaded Application on Startup

Follow these steps to run the FactoryTalk View .mer application currently loaded in the terminal on startup. This is typical when running a closed system.

1. Press Terminal Settings>Startup Options.

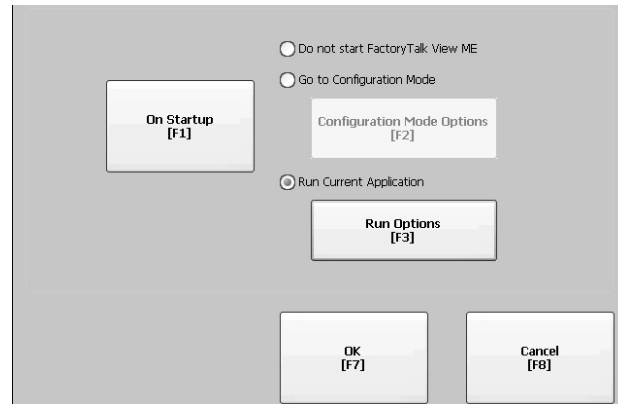

2. Press On Startup to select Run Current Application.

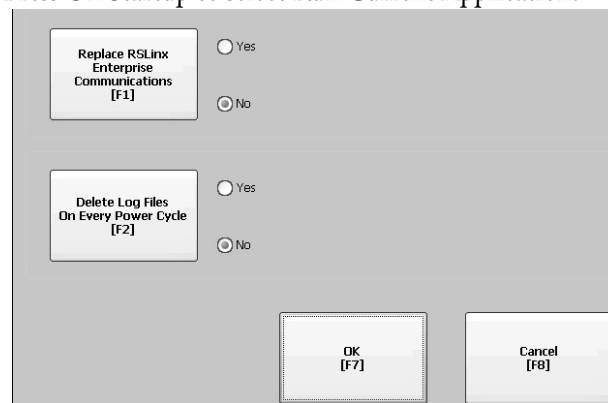

If an application is not loaded, the options are disabled.

3. Press Replace RSLinx Enterprise Communications to specify what configuration settings to use when running the application:
  - Select No to use the RSLinx configuration of the terminal.
  - Select Yes to use the configuration of the application. The terminal configuration is replaced with the application settings. Any changes to device addresses or driver properties in RSLinx communication are lost.
4. Press Delete Log Files On Every Power Cycle to specify what action to take with the log files on startup:
  - Select Yes to delete all log files (data, alarm history, alarm status) generated by the terminal before running application. The files are deleted from the system default location.
  - Select No to retain all log files.
5. Press OK twice to return to Terminal Settings.

## Desktop Access

You can allow or restrict access to the Windows desktop on all terminals. From the desktop, you can perform system and control panel operations, or run third-party applications. Terminals with extended features can additionally run viewers, media players, and launch the web browser. You can allow access temporarily to perform specific tasks, then disable desktop access to prevent unauthorized changes.

Typically, a terminal does not allow desktop access unless it has extended features.

**TIP** All terminals are shipped from factory with desktop access disabled.

With restricted access, the only way to access the desktop is to first enter a password. The terminals are shipped from the factory with a default password and challenge question that we recommend you change:

- Default password = password (case sensitive)
- Default challenge question = What is the opposite of lock?
- Default challenge answer = unlock (case sensitive)

When desktop access is set to allow, you can access the desktop by pressing Exit from FactoryTalk View ME Station Configuration mode.

### Enable Desktop Access

Follow these steps to enable desktop access.

1. Press Terminal Settings>Desktop Access Setup.
2. Press Desktop Access to select Allow.

The Enter Password dialog box appears.

**TIP** Each time you change access from disallow to allow, you are required to enter a password. The initial default password is 'password'.

3. Press Password to enter the password and press Enter.
4. Press Enter again to return to Desktop Access Management.

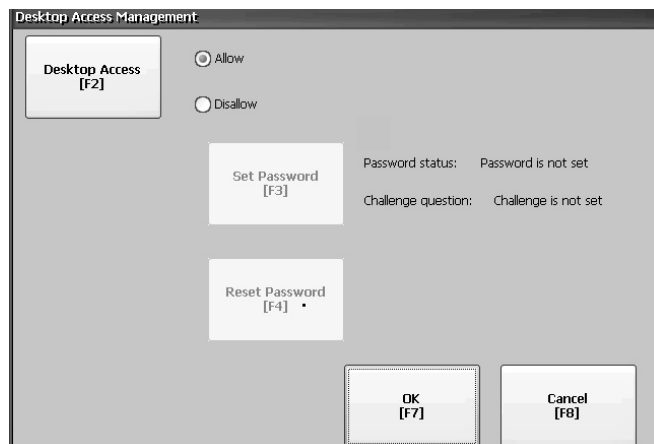

Notice that the password has been cleared.

5. Press OK to exit Desktop Access Management, then Close to exit Terminal Settings.
6. Press Exit from FactoryTalk View ME Station Configuration mode to access the desktop.

With desktop access set to allow, you are not required to enter a password.

## Disable Desktop Access

To restrict desktop access, the FactoryTalk View ME Station start-up option must be set to one of these options:

- Go to Configuration Mode (this is the default)
- Run Current Application

See [page 49](#) for details on how to change the start-up option.

You also are required to enter a password and challenge question:

- The password is required to access the desktop from FactoryTalk View ME Station Configuration mode when pressing Exit.
- The challenge question and response are required to change the password with the Reset Password function.

Follow these steps to disable desktop access.

1. Press Terminal Settings>Desktop Access Setup.
2. Press Desktop Access to select Disallow.

The Set Password button is enabled.

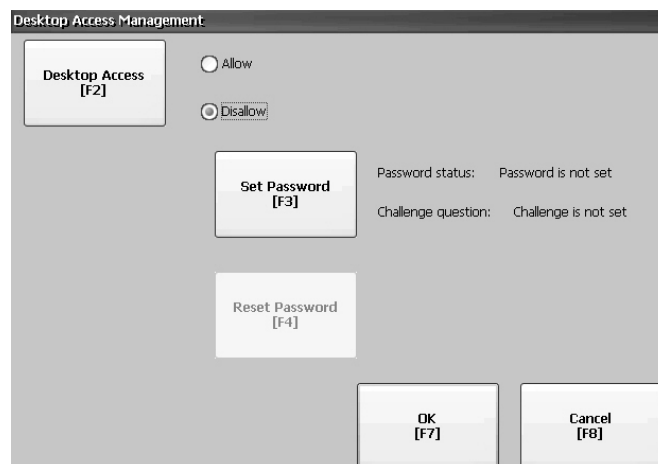

**TIP** If the start-up option was not set to Run Current Application or Go to Configuration mode, you get an error.

3. Refer to [Set a Desktop Password on page 54](#) to set a password and challenge question.

You must set a password and challenge question when disabling desktop access or you get an error message.

## Set a Desktop Password

---

**IMPORTANT** If you disallow or restrict access to the desktop, you are required to set a password along with a challenge question.

---

Follow these steps to set a new password.

1. Press Set Password from Desktop Access Management.

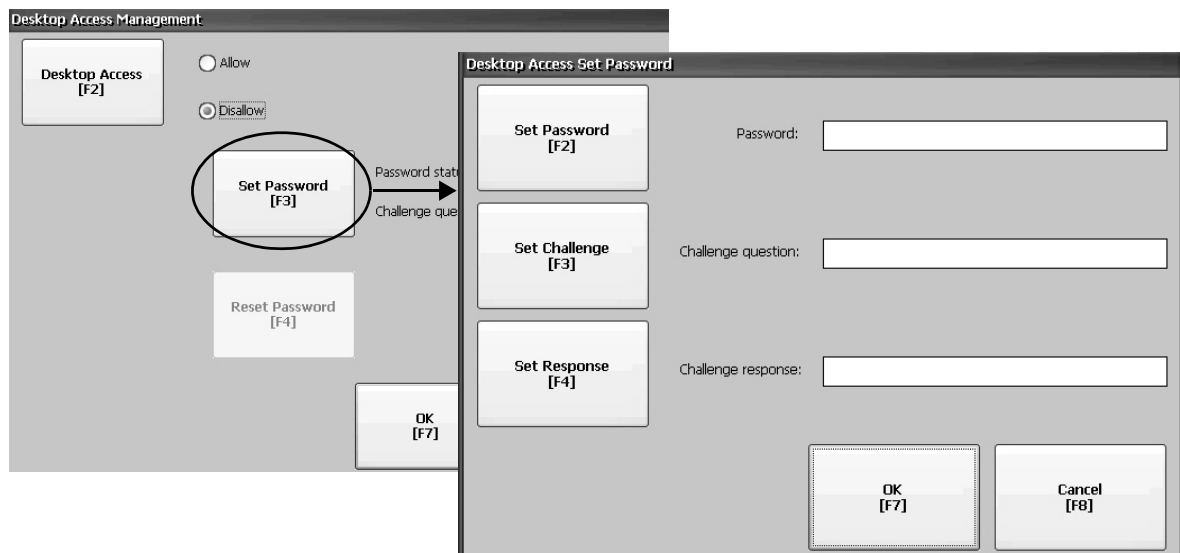

2. Press Set Password and enter an 8...20 character password, then press Enter.

**TIP** You must correctly enter this password before accessing the desktop.

3. Press Set Challenge and enter a question that you must correctly respond to before changing the password with the Reset Password button.
4. Press Set Response to enter the response to the challenge question, then press Enter.
5. Press OK.

The Desktop Access Management dialog box shows that a password and challenge question are set.

6. Press OK to return to Terminal Settings.

---

**IMPORTANT** Secure your password and challenge question for future use. To clear and reset the password, you must correctly respond to the challenge question. If you forget the response, the only way to clear the password is to restore the factory default settings on the terminal. Refer to [Access Maintenance Operations on page 170](#) for details on how to restore factory defaults.

---

## Reset the Desktop Password

To clear the current password and reset a new password, you must first correctly respond to the current challenge question. If you cannot remember the response, you have to restore the terminal to its factory default settings. Refer to [Access Maintenance Operations on page 170](#).

---

**IMPORTANT** You can clear and reset the password and challenge question if access to the desktop is restricted or set to disallow.

---

Follow these steps to reset a desktop access password.

1. Press Reset Password from Desktop Access Management.

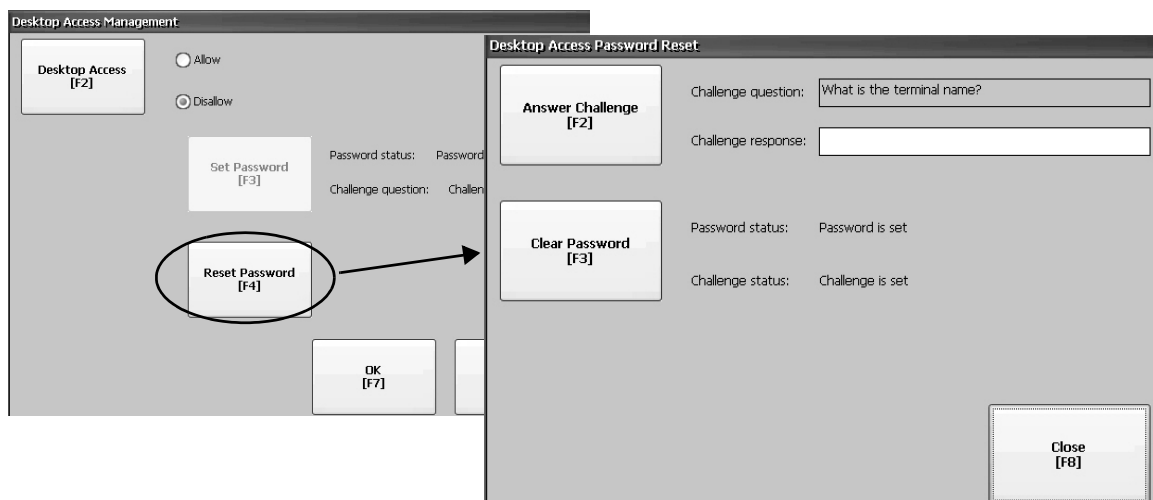

2. Press Answer Challenge and enter the correct response to the current challenge question.
  3. Press Clear Password to clear the current password and challenge question.
- The status of the password and challenge information is updated.

Password status: Password is not set  
 Challenge status: Challenge is not set

4. Press Close.
5. Follow the [Set a Desktop Password](#) procedure on [page 54](#) to set a new password and challenge question.

After the password is cleared, you must set a new desktop password or change the desktop access to allow.

## Communication Setup

You configure communication for your application and controller by using RSLinx Enterprise software:

- Access KEPServer Serial Port IDs.
- Edit the driver settings for the protocol used by your .mer application.
- Edit the device address of the controller on the network.

### Configure KEPServer Serial Port IDs

To access KEPServer serial communication, you must have KEPServer Enterprise installed on your terminal. If you plan on using KEPServer Enterprise and serial communication, you must specify the COM port to use.

To access the KEPServer Serial Port ID dialog box, press Terminal Settings>Networks then Communications>KEPServer Serial Port IDs. If KEPServer Enterprise is not installed, you get an error message.

### Configure RSLinx Communication Properties

Follow these steps to configure driver settings for the communication protocol used by your application.

1. Press Terminal Settings>Networks then Communications>RSLinx Enterprise Communications.

You see a tree view of installed cards and network configurations.

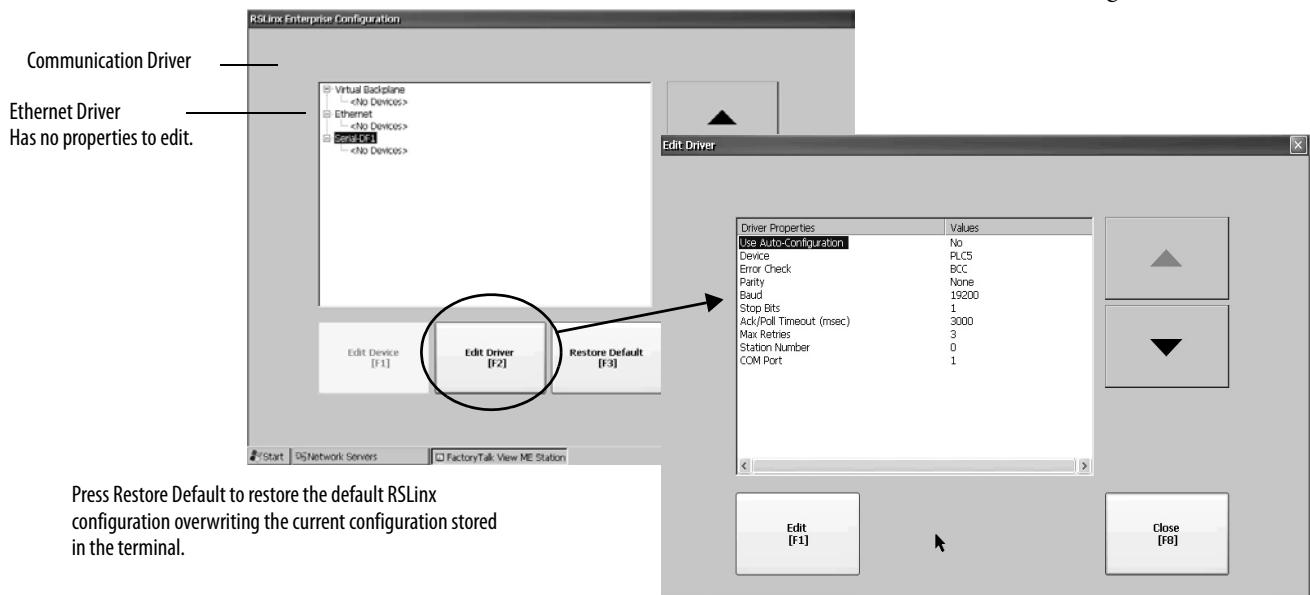

2. Select a communication card installed on your terminal.
3. Press Edit Driver to view the current driver properties.
4. Select a property to modify, then press Edit.
5. Modify the setting, then press Enter.

You return to the previous dialog box with the newly entered data.



**Table 46 - Communication Driver Properties**

Field	Description	Valid Values
<b>Serial Properties</b>		
Use Auto Config	Automatically or manually configures the baud rate, parity, and error checking parameters.	Yes (auto configure) No (manual configure)
Device	The serial device terminal is connected to.	PLC-5 <sup>®</sup> , SLCT <sup>™</sup> , MicroLogix <sup>™</sup> , Logix Platform
Error Check	Type of error checking used. Error checking is automatically configured if Use Auto Config is set to Yes.	BCC, CRC
Parity	Type of parity used. Parity is automatically configured if Use Auto Config is set to Yes.	None, Odd, Even
Baud Rate	Data rate at which serial driver communicates. The baud rate is automatically configured if Use Auto Config is set to Yes.	110, 300, 600, 1200, 4800, 9600, 19200, 38400, 57600, 115200
Stop Bits	Number of stop bits used.	1 or 2
Ack/Poll Timeout	Ack/Poll timeout value in ms.	20...60,000 ms
Max Retries	Number of retries before serial driver fails.	0...10
Station Number	Station number based on a specific device.	0...254
COM Port	Communication port used on the terminal.	1...4
<b>DHPlus Properties</b>		
Jumper ID	Identifies the communication card if multiple cards are installed on terminal.	0...3
Station Number	The unique address of terminal on the DHPlus network.	0...77 (octal)
Baud Rate	The communication rate of the DHPlus network.	57,600 (default) 115,200 230,400
<b>DH-485 Properties</b>		
Jumper ID	Identifies the communication card if multiple cards are installed on terminal.	0...3
Station Number	The unique station number of the terminal on the DH-485 network.	0...31 (decimal)
Baud Rate	The communication rate of the DH-485 network.	9600 19200
MaxStationNumber	The maximum station number on the DH-485 network. The value must be greater than or equal to the Station Number.	0...31 (decimal)
<b>ControlNet Properties</b>		
Device ID	Unique address of the PanelView Plus 6 terminal on the ControlNet network.	1...99

## Configure a Device Address

Follow these steps to edit the address of a device such as a logic controller.

1. From the RSLinx Configuration dialog box, select a device node.
2. Press Edit Device to view the device name and current address.

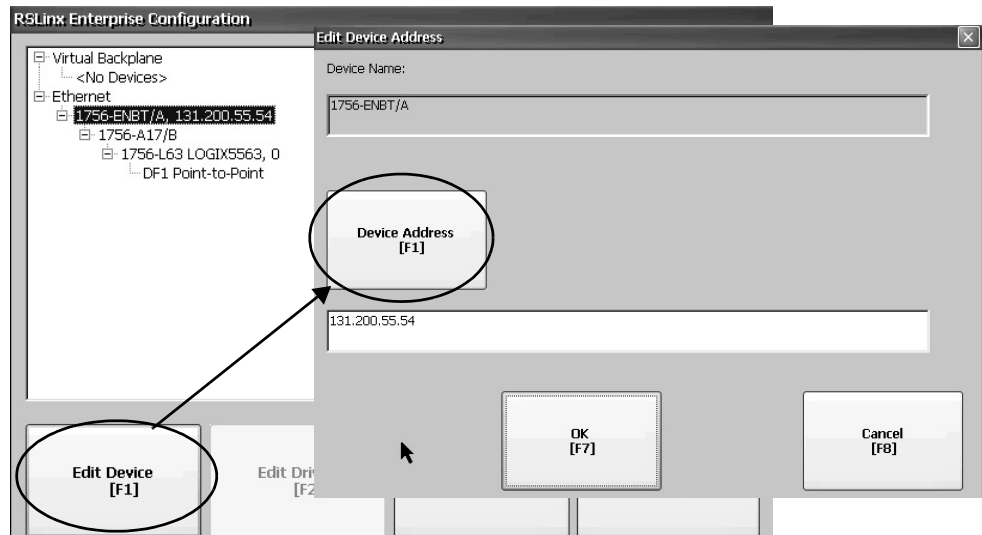

3. Press Device Address to modify the address.  
The input panel opens with the current address.
4. Use the Input Panel to modify the address and then press Enter.  
You return to the previous dialog box with the new address.
5. Press OK.  
Modified settings do not take effect until the terminal is restarted.

## Ethernet Network Connections

The terminal has a built-in Ethernet driver. You can configure this Ethernet information for your terminal:

- IP address of terminal on network including link speed
- Device name to identify terminal on network
- Username and password to access network resources

---

**IMPORTANT** FactoryTalk View ME Station does not recognize an installed 2711P-RN20 Ethernet module. View and manually configure the module's IP address from the control panel by using Network and Dial-up Connections.

---

## Set the Ethernet IP Address for the Terminal

Some networks automatically assign IP addresses to Ethernet devices if DHCP is enabled. If DHCP is not enabled, you can manually enter an IP address.

Follow these steps to view or enter the IP address of your terminal.

1. Press Terminal Settings>Networks then Communications>Network Connections>Network Adapters.

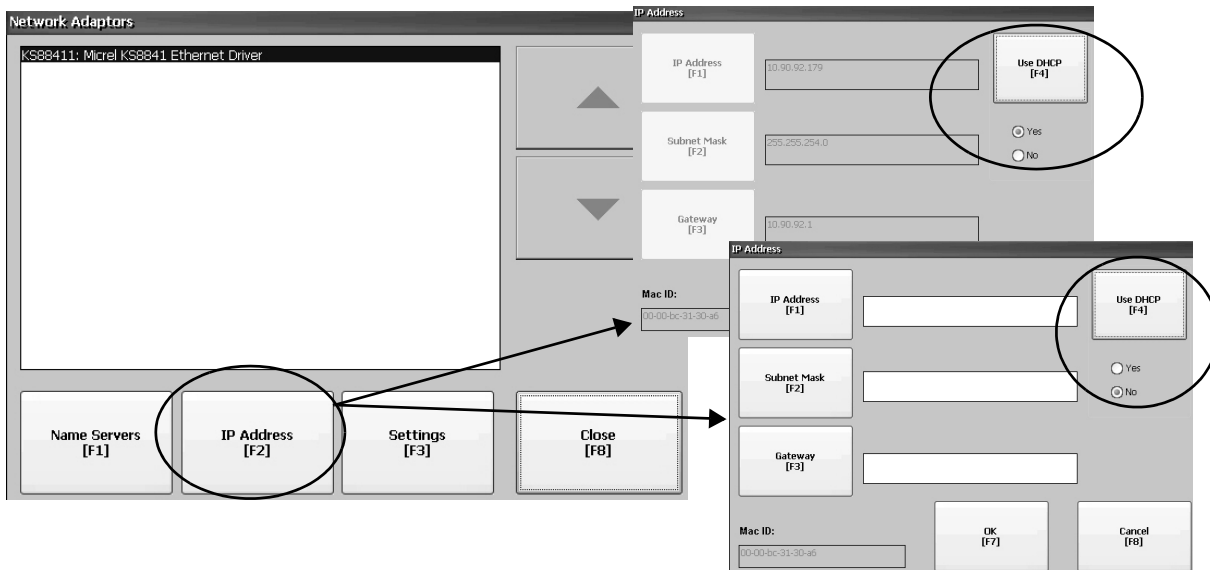

2. Press IP Address to view or modify the IP address.
3. Press Use DHCP to enable or disable DHCP assignment of addresses:
  - If DHCP is enabled or set to Yes, IP address are automatically assigned.
  - If DHCP is disabled, you can manually enter IP address. Press IP address, Subnet Mask, and Gateway to enter IP formatted addresses.
4. Press OK when done.

If prompted, reset the device from the FactoryTalk View ME Station Configuration mode dialog box.

5. Press Close.

Field	Description	Valid Values
Use DHCP	Enables or disables Dynamic Host Configuration Protocol (DHCP) settings. DHCP automatically allocates network devices and configurations to newly attached devices on the network: <ul style="list-style-type: none"> <li>• If DHCP is set to Yes, the terminal is automatically assigned an IP address, Subnet Mask, and Gateway. The fields are disabled.</li> <li>• If DHCP is set to No, you can enter the IP address, Subnet Mask, and Gateway address.</li> </ul>	Yes (default) No
IP Address	A unique address identifying the terminal on the Ethernet network.	xxx.xxx.xxx.xxx 000.000.000.000 (default) <ul style="list-style-type: none"> <li>• Range of values for the first set of decimal numbers is 1...255 unless all fields are set to 000.</li> <li>• The range of values for the last three sets of decimal numbers is 0...255.</li> </ul>
Subnet Mask	Address must be identical to the server subnet mask.	xxx.xxx.xxx.xxx
Gateway	Optional Gateway address.	xxx.xxx.xxx.xxx
Mac ID	Read-only field.	

## Set the Ethernet Link Speed

You can set the speed and duplex setting of the Ethernet link.

**TIP** Link settings for the 2711P-RN20 Ethernet module cannot be set in FactoryTalk View Machine Edition Station. The module is set to automatically sense the settings on the network.

1. Press Terminal Settings>Networks then Communications>Network Connections>Network Adapters.

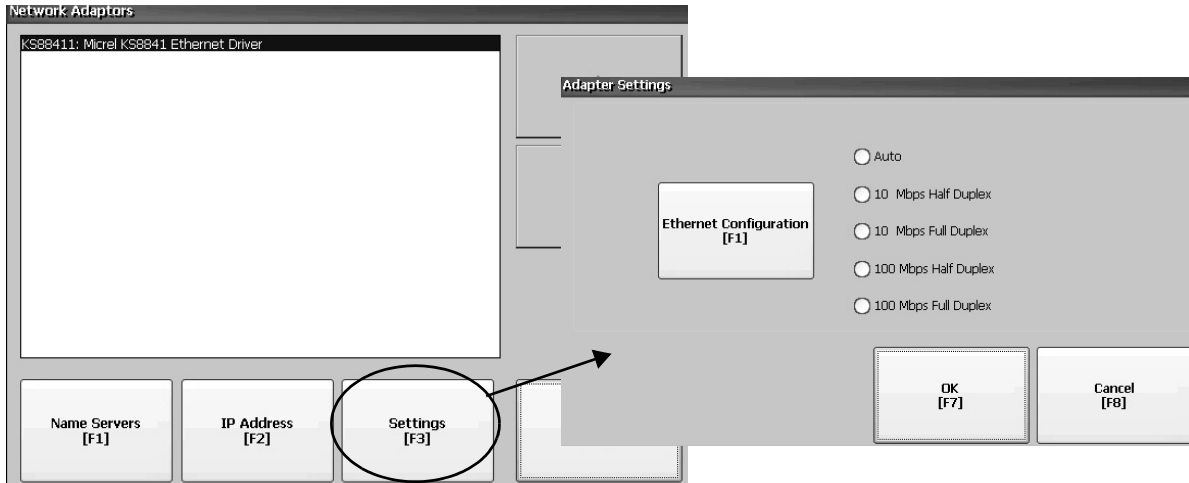

2. Press Settings to view or modify the Ethernet link settings.
3. Press Ethernet Configuration to select an Ethernet link option for your Ethernet connection.

The Auto option automatically senses the link option and speed based on the terminal connection to a network.

## Define Name Server Addresses

You can define name server addresses for the EtherNet/IP network adapter. These addresses are automatically assigned if DHCP is enabled for the adapter.

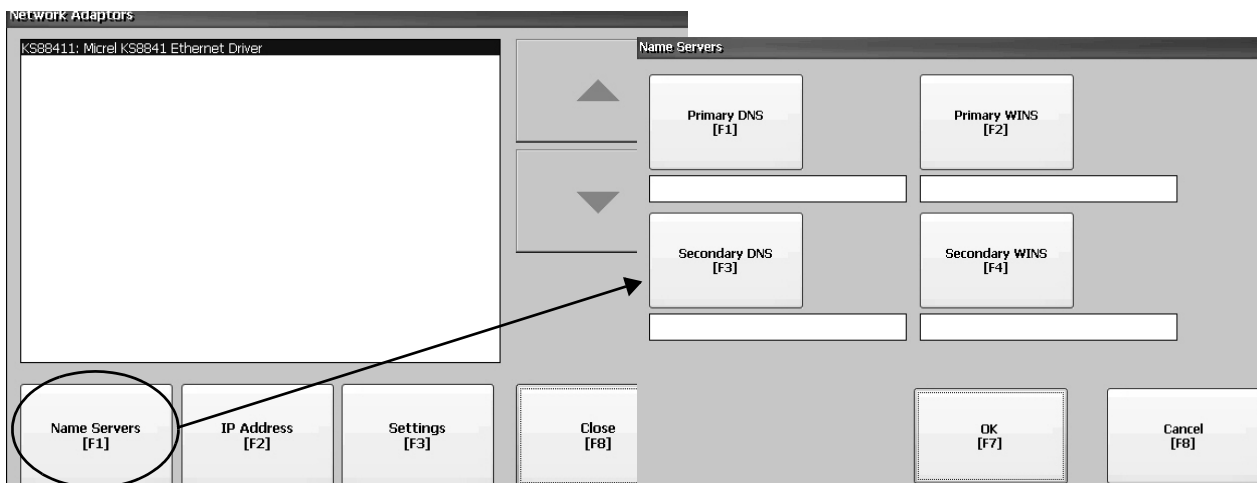

Follow these steps to define a name server address.

1. Press Terminal Settings>Networks then Communications>Network Connections>Network Adapters.
2. Press Name Servers.
3. Press the following fields to enter a name server address.

Field	Description	Valid Values
Primary DNS	The address of the primary DNS resolver.	xxx.xxx.xxx.xxx
Secondary DNS	The address of the secondary DNS resolver.	xxx.xxx.xxx.xxx
Primary WINS	The address of the primary WINS resolver.	xxx.xxx.xxx.xxx
Secondary WINS	The address of the secondary WINS resolver.	xxx.xxx.xxx.xxx

4. Press OK when done.

### View or Change Terminal Device Name

Each terminal has a default device name and description that is used to identify the terminal on the network. You can view or modify this information.

1. Press Terminal Settings>Networks then Communications>Network Connections>Device Name.

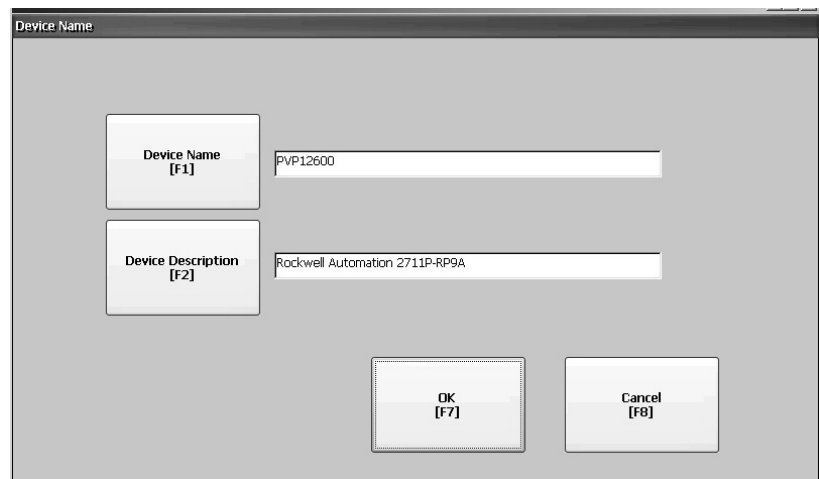

2. Press Device Name to enter or edit the device name.
3. Press Device Description to enter a description for the device.

Field	Description	Valid Values
Device Name <sup>(1)</sup>	Unique name that identifies the terminal to other computers on the network.	1...15 characters <ul style="list-style-type: none"> <li>• A leading character in the range of a through z or A through Z.</li> <li>• Remaining characters in the range of a through z, A through Z, 0...9, or - (hyphen)</li> </ul>
Device Description	Provides a description of the terminal. The default is device catalog number.	50 characters max

(1) Check with your network administrator to determine a valid device name.

4. Press OK.

## Authorize Terminal to Access Network Resources

The terminal can access network resources with proper identification. A user name, password, and domain must be provided by your network administrator.

1. Press Terminal Settings>Network then Communications>Network Connections>Network Identification.

2. Press user name, password, and domain to enter the information provided by your network administrator.

Field	Description	Valid Values
User Name	Identifies the user to the network.	70 characters max
Password	Characters that gain access to network along with the user name.	No character limitation
Domain Name	Provided by network administrator.	15 characters max

3. Press OK when done.

## File Management

The terminal supports operations for managing files that are stored on the terminal:

- Deleting application .mer files, font files, or generated log files
- Copying application files or font files between storage locations

### Delete Application File or Font File

You can delete FactoryTalk View ME Station .mer files or font files that reside in nonvolatile memory of the terminal, a loaded USB flash drive, or a loaded SD card. The procedure for deleting an application file or a font file is the same.

1. Press Terminal Settings>File Management>Delete Files>Delete Applications or Delete Fonts.

2. Press Source to select the storage location of the application or font file you want to delete:
  - Internal Storage - nonvolatile memory of the terminal
  - External Storage 1 - SD card loaded in the card slot of the terminal
  - External Storage 2 - USB flash drive connected to a USB host port

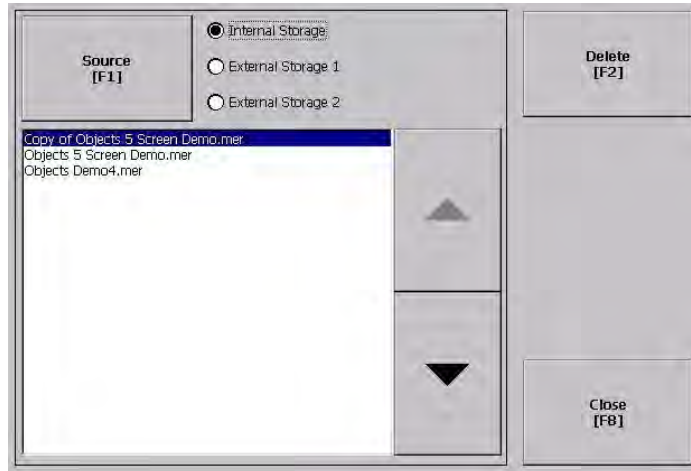

3. Select a file from the list.
4. Press Delete.
5. Select Yes or No when asked if you want to delete the selected application or font file from the storage location.

## Delete Log Files

You can delete generated log files, alarm history files, and alarm status files from the System Default location on the terminal.

1. Press Terminal Settings>File Management>Delete Files>Delete Log Files.  
You are asked to confirm the deletion of the files.

Do you want to delete all of the FactoryTalk View ME Station Log Files?

2. Select Yes or No.

Log files not in the System Default location are not be deleted.

## Copy Application File or Font File

You can copy FactoryTalk View ME Station application .mer files or font files from one storage location to another in the terminal. The procedure for copying an application file or a font file between storage locations is the same.

1. Press Terminal Settings>File Management>Copy Files>Copy Applications or Copy Fonts.

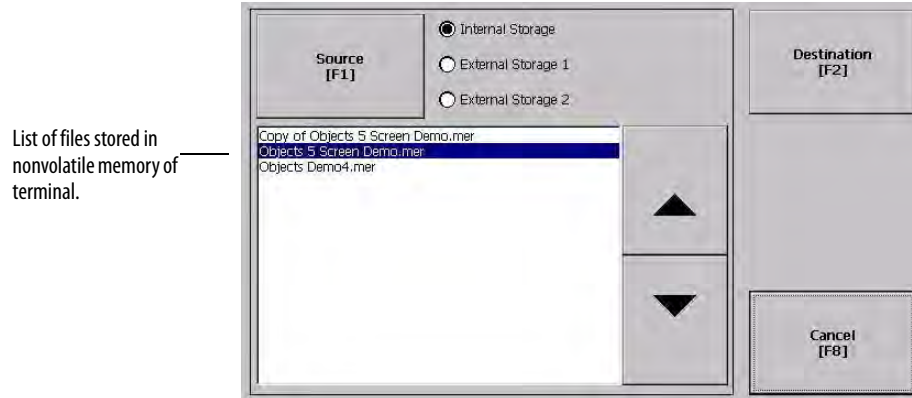

2. Press Source to select the location of the file you want to copy:
  - Internal Storage - nonvolatile memory of the terminal
  - External Storage 1 - SD card loaded in the card slot of the terminal
  - External Storage 2 - USB flash drive connected to a USB host port
3. Select a file from the storage location.
4. Press Destination on the same dialog box.

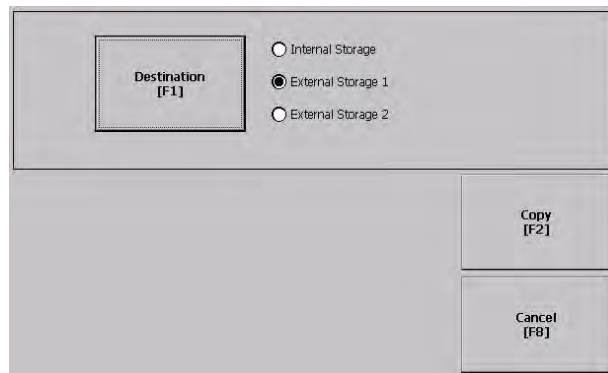

5. Press Destination to select the location to copy the file. The destination must be different than the source location.
6. Press Copy to copy the selected file to the destination. If the file exists, you are asked if you want to overwrite the file.
7. Select Yes or No.

**TIP** FactoryTalk View ME Station software looks for .mer files in the My Device\Application Data\Rockwell Software\RSViewME\Runtime\ folder and font files in the \Rockwell Software\RSViewME\Fonts\ folder.



## Display Settings

For the terminal display, you can adjust its intensity, view its temperature, configure the screen saver, or enable/disable the screen cursor.

### Adjust the Display Intensity

You can modify the intensity of the terminal backlight. You can use the default intensity of 100% or you can change the intensity for runtime operations.

1. Press Terminal Settings>Display>Display Intensity.

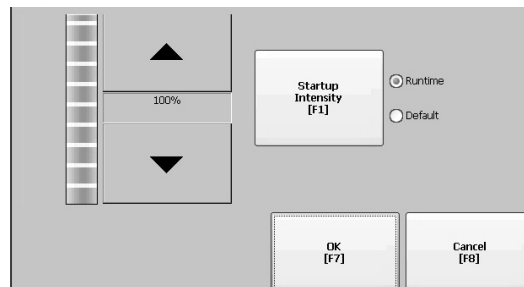

2. Press Startup Intensity to switch between the Default intensity and the Runtime intensity.
  - If you select Runtime, the start-up screens use the runtime intensity.
  - If you select Default, the start-up screens use the default setting, 100%
3. Increase or decrease the intensity for runtime operations, by pressing the up or down arrow keys.
4. Press OK when done to save the intensity changes.

### View the Display Temperature

To view the current temperature of the 700 to 1500 CCFL-displays only, press Terminal Settings>Display>Display Temperature.



700 to 1500 terminals with a cold-cathode fluorescent lamp (CCFL) backlight require temperature control when the internal temperature of the product is below 10 °C (50 °F) or above 60 °C (140 °F). If the internal temperature is:

- Below 10 °C (50 °F), the backlight is set to overdrive or the full-rated current setting for at least five minutes. This increases heat generation from the backlight.
- Above 60 °C (140 °F), the backlight is set to underdrive; 40% or less of full brightness. This reduces heat generation from the backlight.

Temperature monitoring begins when the backlight turns on at startup or when the screen saver is deactivated. The temperature control affects display intensity only; it does not restrict the use or operation of the terminal.

When a low or high temperature condition is detected, an error is sent to the system event log. If the temperature control is not functioning, a noncritical error is sent to the system event log but the terminal continues to operate normally.

**TIP** Temperature control takes precedence over the application backlight settings.

## Configure the Screen Saver

The screen saver on the terminal activates after an idle period at a specific intensity. The default idle timeout is 10 minutes. You can adjust the idle timeout and intensity level for the screen saver, disable the screen saver, and enable or disable the screen saver bitmap.

1. Press Terminal Settings>Display>Screen Saver.

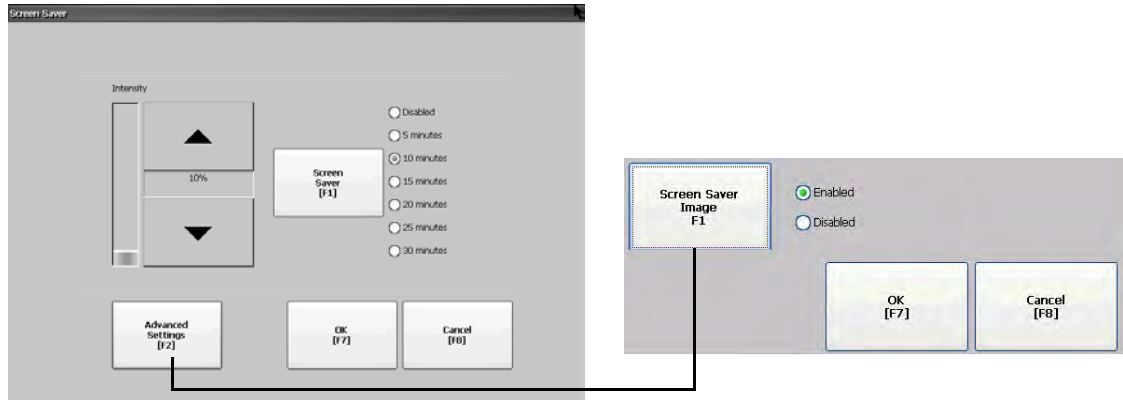

2. Press Screen Saver to select an idle timeout for activating the screen saver. To disable the screen saver, select the Disabled option.
3. Increase or decrease the brightness intensity of the screen saver by pressing the up and down cursor buttons.
4. Press Advanced Settings to access the bitmap option.
  - a. Press Screen Saver Image to enable or disable the screen saver bitmap. Refer to [Screen Saver on page 95](#) for details on how to set the bitmap.
  - b. Press OK to return to the previous.
5. Press OK to exit and return to the terminal settings.

## Enable or Disable the Screen Cursor

The terminal has a screen cursor that you can enable or disable.

1. Press Terminal Settings>Display>Cursor.

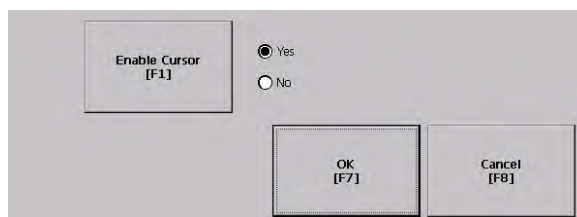

2. Press Enable Cursor to enable or disable the cursor.
3. Press OK to exit and return to Terminal Settings.

## Input Device Settings

You can adjust the settings for input devices used by the terminal including the keypad, attached keyboard, mouse, touch screen, and string entry popup.

### Configure Keyboard or Keypad Settings

You can adjust settings for keys on an attached keyboard or the terminal keypad.

1. Press Terminal Settings>Input Devices>Keyboard/Keypad.

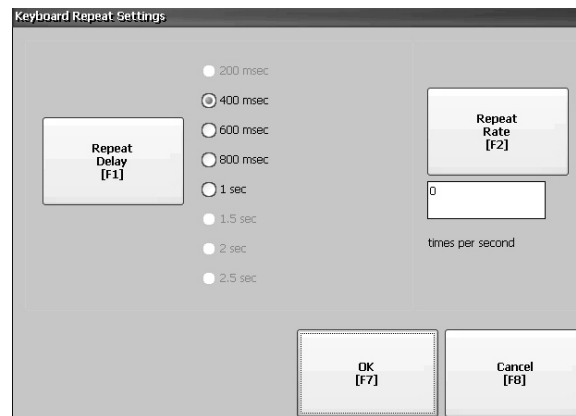

2. Press Repeat Rate to specify the number of times a key is repeated per second when you hold a key down.  
Valid values for the keypad are 0 and 2...30. The keyboard is device dependent but typical values are the same.
3. Press Repeat Delay to select the amount of time that elapses per second before a key is repeated.  
Values are device dependent. Unsupported values are dimmed.
4. Press OK when done.

### Set the Sensitivity of the Mouse

You can set and test the sensitivity for both the speed and physical distance between mouse clicks. The process is identical to setting the double-tap sensitivity for the touch screen. See [page 69](#).

To set the mouse sensitivity, press Terminal Settings>Input Devices>Mouse.

## Change the Popup for String Entry

You can specify whether to use the standard input panel for data entry or a string popup. The popup keyboard is the default.

1. Press Terminal Settings>Input Devices>String Popup.

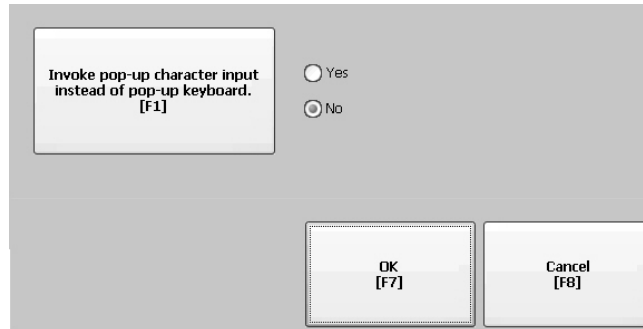

2. Press Invoke pop-up character input instead of popup keyboard to select the preferred input method for string entry.
3. Press OK.

## Calibrate a Touch Screen

Follow these steps to calibrate the touch screen.

---

**IMPORTANT** Use a plastic stylus device with a minimum tip radius of 1.3 mm (0.051 in.) to prevent damage to the touch screen.

---

1. Press Terminal Settings>Input Devices>Touch Screen>Calibration.

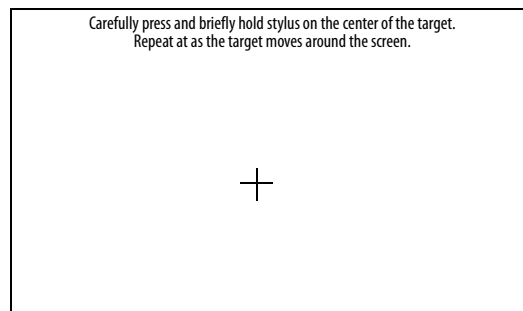

2. Follow the instructions on the screen.

When the calibration is complete, you see a message that indicates new calibration settings have been measured.

On terminals with a touch screen only	<ul style="list-style-type: none"> <li>• Press the screen to register saved data.</li> <li>• Wait for 30 seconds to cancel saved data and keep the current settings.</li> </ul>
On terminals with a keypad and touch screen	<ul style="list-style-type: none"> <li>• Press the Enter key to accept new settings</li> <li>• Press the Esc key to keep old settings.</li> </ul>

## Set Double-tap Sensitivity for a Touch Screen

You can set and test the sensitivity for both the speed and physical distance between touch-screen presses. The process is identical to setting the double-click sensitivity for the mouse.

1. Press Terminal Settings>Input Devices>Touch Screen>Double Tap Sensitivity.

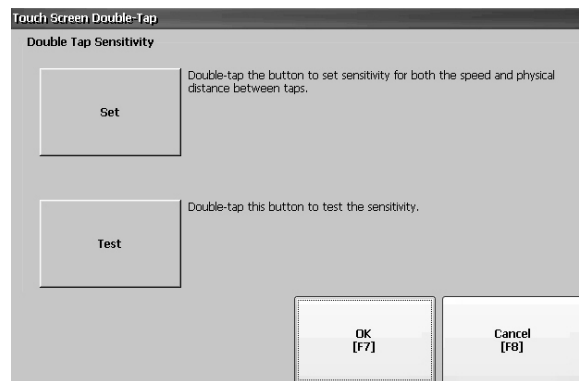

2. Double-tap Set to set the sensitivity of touch-screen presses.
3. Double-tap Test to test the sensitivity of touch-screen presses. The Test button reverses its foreground and background colors.
4. Press OK when done.

## Configure Print Options

You can configure settings for printing displays, alarm messages, or diagnostic messages from FactoryTalk View ME Station applications. The setup for printing displays and messages is the same; advanced settings are different.

PanelView Plus 6 terminals are shipped with support for a large selection of Canon, Epson, Hewlett-Packard, and Brother Printers. Printer installation attempts to use USB Plug-and-Play capabilities to the extent that known printers are mapped automatically to the appropriate driver. The printing solution lets applications and users to select, manage, and share printers without knowing the underlying details of the printer. Printers that do not configure automatically to the appropriate driver can be installed manually.

Follow these steps to access the print setup.

1. Press a Terminal Settings>Print Setup> option:
  - Alarm Print Setup
  - Diagnostic Setup
  - Display Print Setup

Print Setup displays installed printers that are available to the FactoryTalk View Machine Edition application.

The terminals are not shipped with pre-configured printers so initially the dialog box appears empty. The appearance of the dialog box depends on what printers you install.

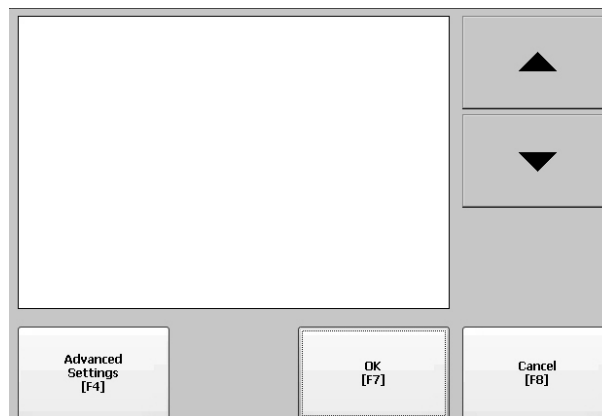

2. Select an installed printer.

**TIP**

The printer you select must be listed in Control Panel Printers applet. For a list of supported printers, go to: <http://www.rockwellautomation.com/knowledgebase> and search the Knowledgebase for ID 111636.

A failed attempt to automatically install a printer is reported in the system event log.

A printer that does not install automatically can be installed manually by using the control panel in Windows Explorer.

3. Press Advanced to access additional settings:
  - Advanced settings for printing displays include these:
    - Print orientation (portrait or landscape)
    - Draft mode (enable or disable)
    - Color (yes or no)
  - Advanced settings for printing diagnostic and alarm messages determines when to print messages sent to the network or USB port.

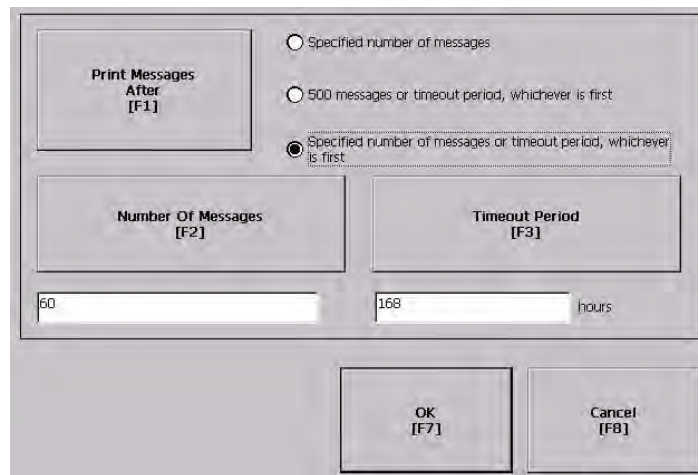

Print Messages After	Default Value	Example
Specified number of messages	60 messages	When the queue has 60 messages, the messages are printed regardless of how long they have been in the queue. You can change the number of messages.
500 messages or timeout period, whichever is first	168 hours (7 days)	If the queue has 350 messages after 168 hours, the 350 messages are printed. You can change the timeout period.
Specified number of messages or timeout period, whichever is first.	60 messages 168 hours (7 days)	If the queue has 60 messages after 24 hours, then the 60 messages are printed. You can change the number of messages and the timeout period.  For example, the number of messages is set to 75 and the timeout period is set to 48 hours. <ul style="list-style-type: none"> <li>• If the queue has 75 messages after 24 hours, then the 75 messages are printed before the set timeout of 48 hours.</li> <li>• If the queue has 15 messages after 48 hours, the 15 messages are printed after the set timeout period.</li> </ul>

4. Press OK when done.
5. Press OK to return to Terminal Settings.

## Check Integrity of Application Files

Periodically check the integrity of the FactoryTalk View ME Station application that is loaded in the terminal and the runtime files. All errors, warnings, and information messages generated by these files are logged to a file. You can periodically view the log and clear all items from the log.

1. Press Terminal Settings>File Integrity Check.

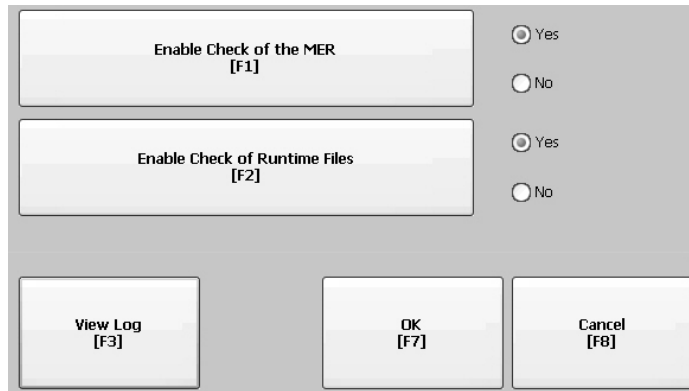

2. Press either of the Enable options to enable or disable file integrity checks:
  - Enable Check of the MER
  - Enable Check of the Runtime Files

By default, integrity checks are automatically performed on the application .mer file and runtime files. If you disable either of these functions, the files are not checked and the log file is not updated.

3. Press OK to save changes.

Follow these steps to view the file integrity check log.

1. Press View Log from the File Integrity Check dialog box.

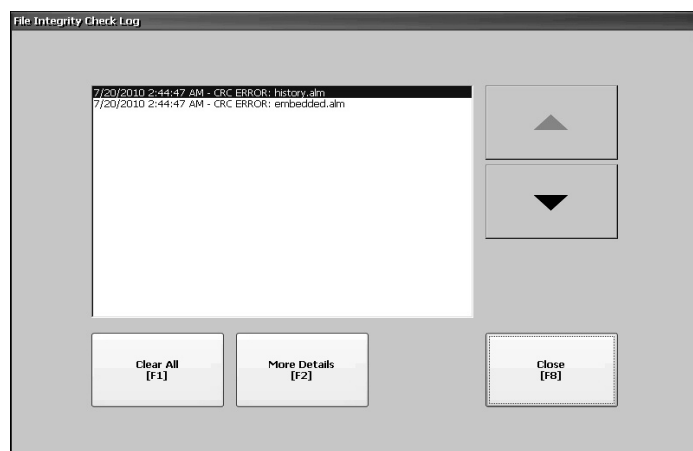

2. Select an event and press More Details to display details for a specific file check event.
3. Press Clear All to clear all details from the log.
4. Press Close to return to previous dialog box.



## Configure Diagnostics

You can configure diagnostics for a target computer. To access diagnostics, press Terminal Settings>Diagnostic Setup from the Configuration Mode dialog box. You see a tree view of diagnostic nodes.

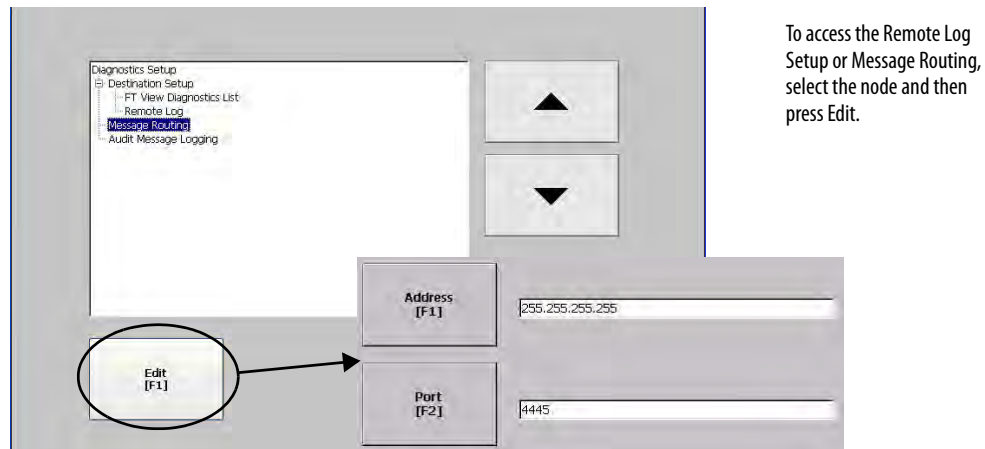

The Remote Log Destination forwards received messages to a Windows computer running diagnostics. The location is determined by the IP address and port number.

Field	Description	Valid Values
Address	Address of the remote Windows computer.	xxx.xxx.xxx.xxx
Port	The port used to communicate with the remote Windows computer.	4445 (default)

The Message Routing dialog box lets you access these dialog boxes:

- Remote Log
- FactoryTalk View Diagnostics List

Each dialog box shows a list of messages that can be sent to that destination. The list shows the status of each message type. Press On/Off to turn a message type on or off. A message type is enabled if it has a checked box.



The Audit Message Logging dialog box lets you log messages as Audit or Information when Edit is pressed.

## View and Clear the System Event Log

The System Event Log dialog box displays warnings, errors, and events logged by the terminal. The log provides a time stamp of when each event occurred and text describing the event. If the event log is full when a new event occurs, the oldest entry is removed to accommodate the new event.

1. Press Terminal Settings>System Event Log.

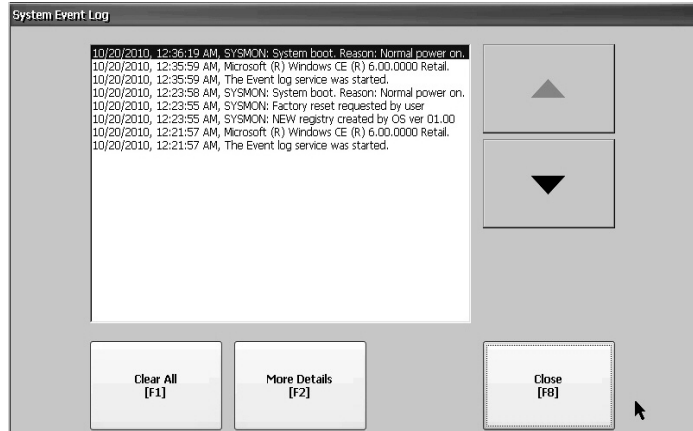

2. Select an event and press More Details to display log details for that event.
3. Press Clear All to clear all system event logs.
4. Press Close.

## System Information

You can view terminal and firmware revision information for software installed on a terminal. This information can be useful during troubleshooting.

### View Terminal Information

This read-only information is provided for the terminal:

- Total power on time in minutes
- Processor temperature (700 to 1500 terminals only)
- Battery voltage and state
- Memory allocated and used on terminal
- RAM memory used during runtime

Follow these steps to display terminal information.

1. Press Terminal Settings>System Information>Terminal Information.

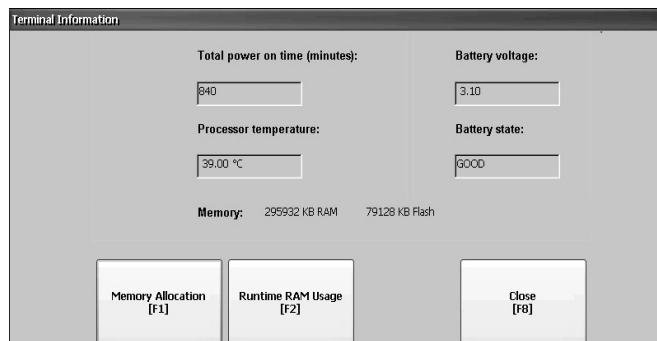

- The CPU temperature must be less than 95 °C (203 °F).
- The battery voltage must be at least 2.75V DC.

Battery State	Description
Good	Good battery condition.
Failing	Low battery. Replace the battery.
Bad	Battery is missing or bad. Replace the battery.

2. Press Memory Allocation to view the following:
  - Amount of allocated storage or program memory
  - Amount of storage or program memory in use
  - Amount of available nonvolatile memory

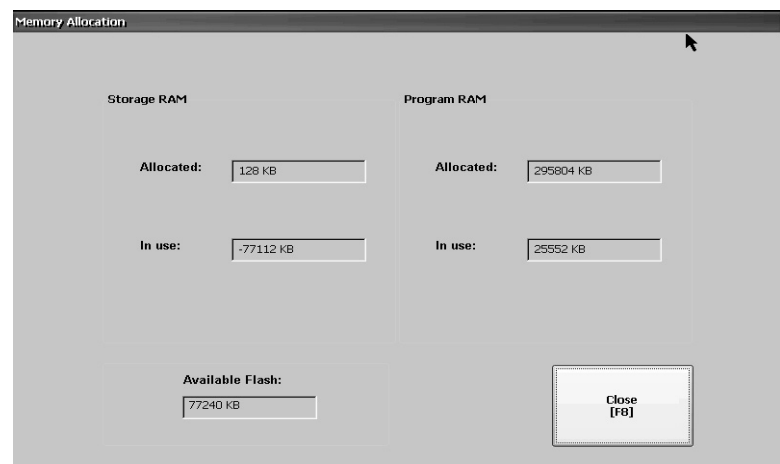

3. Press Close to return to previous dialog box.
4. Press Runtime RAM Usage to troubleshoot runtime anomalies by showing the amount of RAM used by your application at runtime.

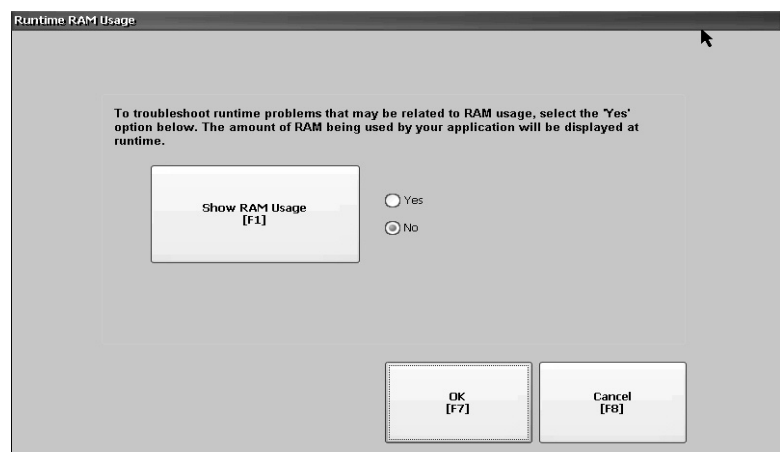

5. Press OK to return to previous dialog box.
6. Press Close until you return to terminal settings.

## Display FactoryTalk View ME Station Information

You can display the firmware and version information for installed system components on your terminal and technical support information.

1. Press Terminal Settings>System Information>About FactoryTalk View ME Station.

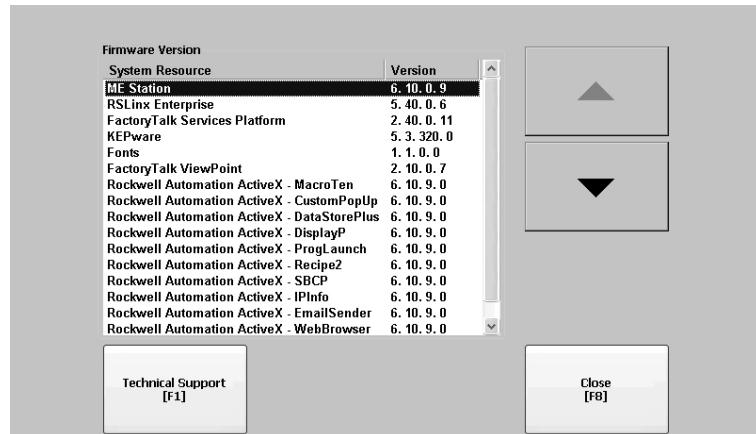

2. Press Technical Support to display the support phone number and website for your terminal.
3. Press Close until you return to terminal settings.

## Enable or Disable the Alarm Display

Each new alarm that occurs on the terminal is displayed in the alarm display or banner. When the newest alarm is acknowledged by the operator, you can choose to close the alarm display or leave it open. By default the alarm display is closed.

1. Press Terminal Settings>Alarms.

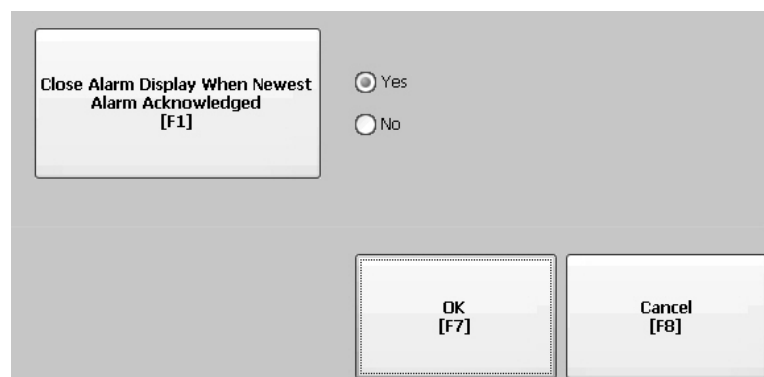

2. Press Yes or No:
  - Yes, the default option, closes the alarm display each time the operator acknowledges the newest alarm.
  - No leaves the alarm display open after the operator acknowledges the newest alarm.
3. Press OK.

## Time and Date Settings

You can change the date, time, time zone, and regional settings for terminal operations.

### Change the Date for Terminal Operations

Follow these steps to adjust the date for terminal operations.

1. Press Terminal Settings>Time/Date/Regional Settings>Date.

The current date appears in the Year, Month, and Day fields.

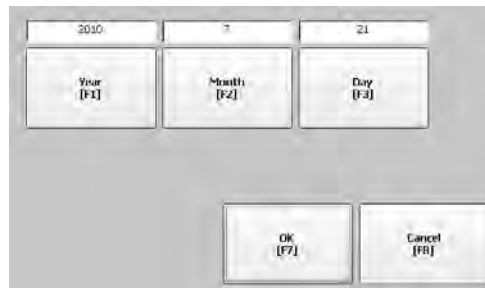

2. Press Year, Month, and Day to change the values.

Field	Description	Valid Values
Year	The current year in a four-digit format.	1980...2099
Month	The current month.	1...12
Day	The current day. The day of the month is validated.	0...31

3. Press OK when done.

### Change the Time for Terminal Operations

Follow these steps to adjust the time for terminal operations.

1. Press Terminal Settings>Time/Date/Regional Settings>Time.

The current time appears in 24-hour format in separate Hour, Minute, and Second fields.

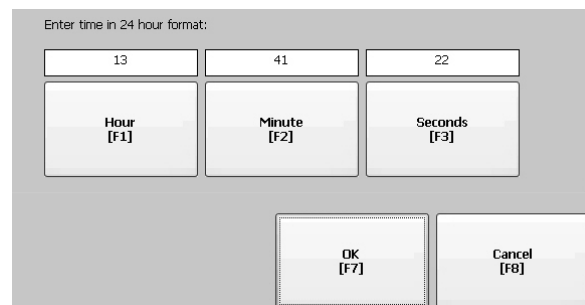

2. Press Hour, Minute, and Seconds to change the values.

Field	Description	Valid Values
Hour	The current hour in 24-hour format.	0...23
Minute	The current minute in 24-hour format.	0...59
Seconds	The current second in 24-hour format.	0...59

3. Press OK when done.

## Change the Time Zone for Terminal Operations

You can view or modify the current time zone that is installed on the terminal. Time zones are installed as a part of the operating system. Changing the time zone adjusts the current time and date to match the new time zone.

1. Press Terminal Settings>Time/Date/Regional Settings>Time Zone.

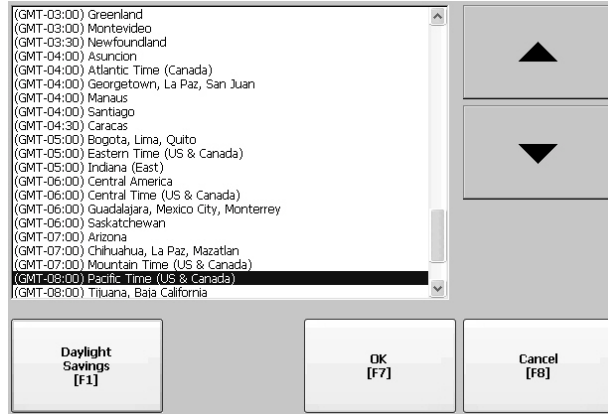

2. Press the up or down cursor to select a time zone.

Language	Default Time Zone
English	(GMT -05:00) Eastern Time (US and Canada)
French	(GMT +01:00) Brussels, Copenhagen, Madrid, Paris
German	(GMT +01:00) Amsterdam, Berlin, Bern, Rome, Stockholm, Vienna
Japanese	(GMT +09:00) Osaka, Sapporo, Tokyo

If the selected time zone supports daylight savings, you can press Daylight Savings.

3. Press Daylight Savings to enable or disable daylight savings for the selected time zone.

Daylight savings is set to Yes for all time zones except for Japanese, which does not support daylight savings. Daylight savings changes are not permanently applied until you close the Time Zone dialog box.

4. Press Use Daylight Savings to select Yes or No.

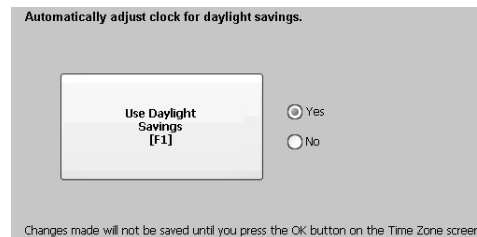

5. Press Close when done.
6. Press OK to return to previous dialog box.

## Regional Settings

You can adjust regional settings for a specific language installed on the terminal, including the date, time and numeric formats. Regional settings are accessed by pressing Terminal Settings>Time/Date/Regional Settings>Regional Settings. The current language is shown at the bottom of the Regional Settings dialo box.

### Select a Language

Before you can modify regional settings for a language, you need to select a language installed on the terminal. Languages are installed as a part of the operating system.

1. Press Terminal Settings>Time/Date/Regional Settings>Regional Settings>Language.

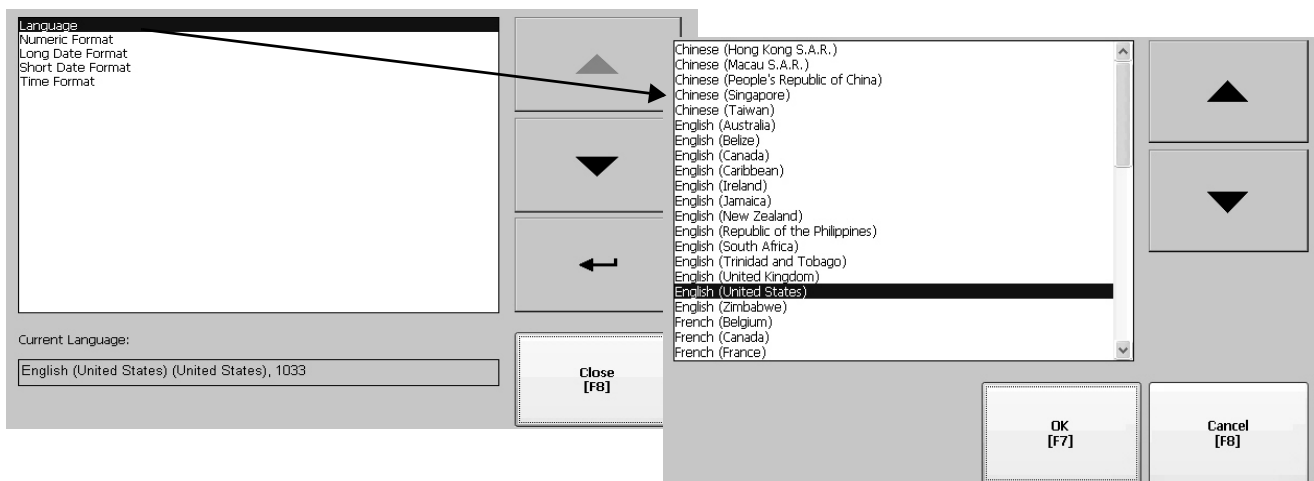

2. Select a language by pressing the up and down cursor keys.
3. Press OK.  
The selected language shows under Current Language on the Regional Settings dialog.

### Change the Decimal Separator for Numeric Formats

You can change the decimal separator used in numerics for the current language. The default decimal separator is a period.

1. Press Terminal Settings>Time/Date/Regional Settings>Regional Settings>Numeric Format.

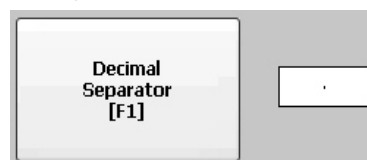

The field shows the default decimal separator. The field accepts a separator up to three characters.

2. Enter up to three characters for the new separator, then press OK.

## Change the Time Format for a Language

Follow these steps to change the time format for the selected language.

1. Press Terminal Settings>Time/Date/Regional Settings>Regional Settings>Time Format.

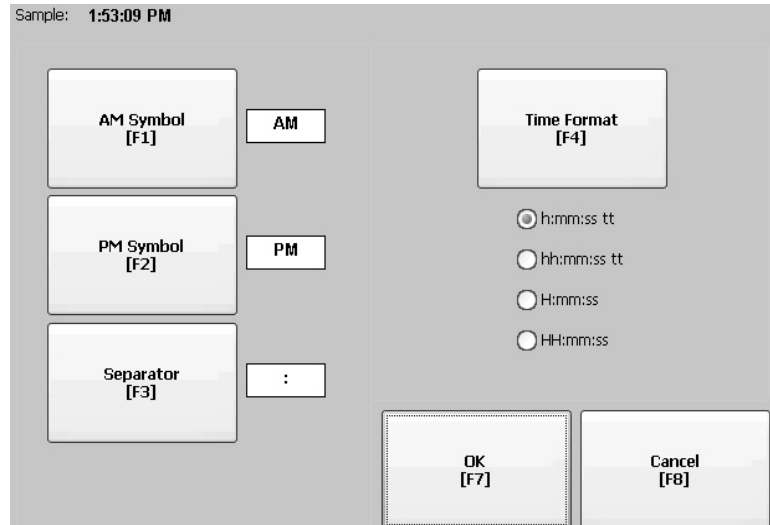

The current time is shown in the currently selected format.

2. Press the appropriate selections to adjust the formats.

Field	Description	Example
Time Format	h:mm:ss tt (default) h = hour, no leading zero tt = AM or PM symbol	7:23:02 AM or 1:13:31 PM 11:43:59 AM
	hh:mm:ss tt hh = hour with leading zero tt = AM or PM symbol	07:23:02 AM or 01:13:31 PM 11:43:59 PM
	H:mm:ss H = hour in 24-hour format, no leading zero	7:03:42 or 1:13:32 23:43:59
	HH:mm:ss HH = hour in 24-hour format with leading zero	07:03:42 or 01:13:22 23:43:59
AM Symbol	Characters to indicate AM. If the time format is set to h:mm:ss tt or hh:mm:ss tt, you can modify the AM symbol.	AM (default) 12 character max
PM Symbol	Characters to indicate PM. If the time format is set to h:mm:ss tt or hh:mm:ss tt, you can modify the PM symbol.	PM (default) 12 character max
Separator	Characters that separate fields in time format.	:(default) 3 character max

3. Press OK.



## Change the Short Date Format for a Language

Follow these steps to change the short date format for the selected language.

1. Press Terminal Settings>Time/Date/Regional Settings>Regional Settings>Short Date Format.

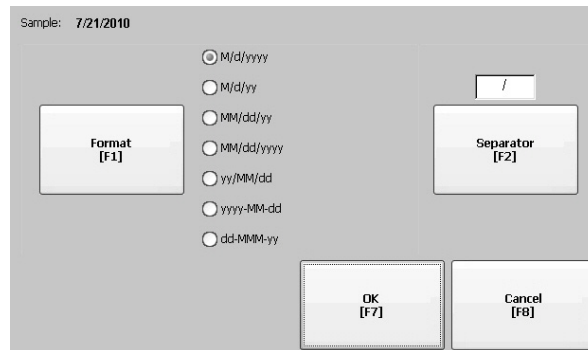

The Sample area shows the current date in the selected format.

2. Press Format to select an available format.

The date is updated in the Sample area as you make selections.

3. Press Separator to change the separator for the date elements.

The separator can be 3 characters. The default separators are – or /.

4. Press OK when done.

## Change the Long Date Format for a Language

Follow these steps to change the long date format used by the selected language.

1. Press Terminal Settings>Time/Date/Regional Settings>Regional Settings>Long Date Format.

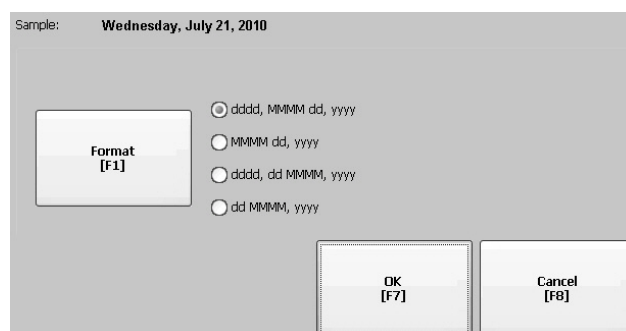

The Sample area shows the current date in the selected format.

2. Press Format to select an available format.

The date is updated in the Sample area as you make selections.

3. Press OK when done.

## Font Linking

Font linking lets you run a translated application on the terminal by linking a font file to the base font (for example, linking a Chinese font file to the base font Arial).

For more details on preinstalled terminal fonts and additional fonts available for downloading, see [Fonts Resident on Terminal on page 175](#).

Press Terminal Settings>Font Linking to access this function.

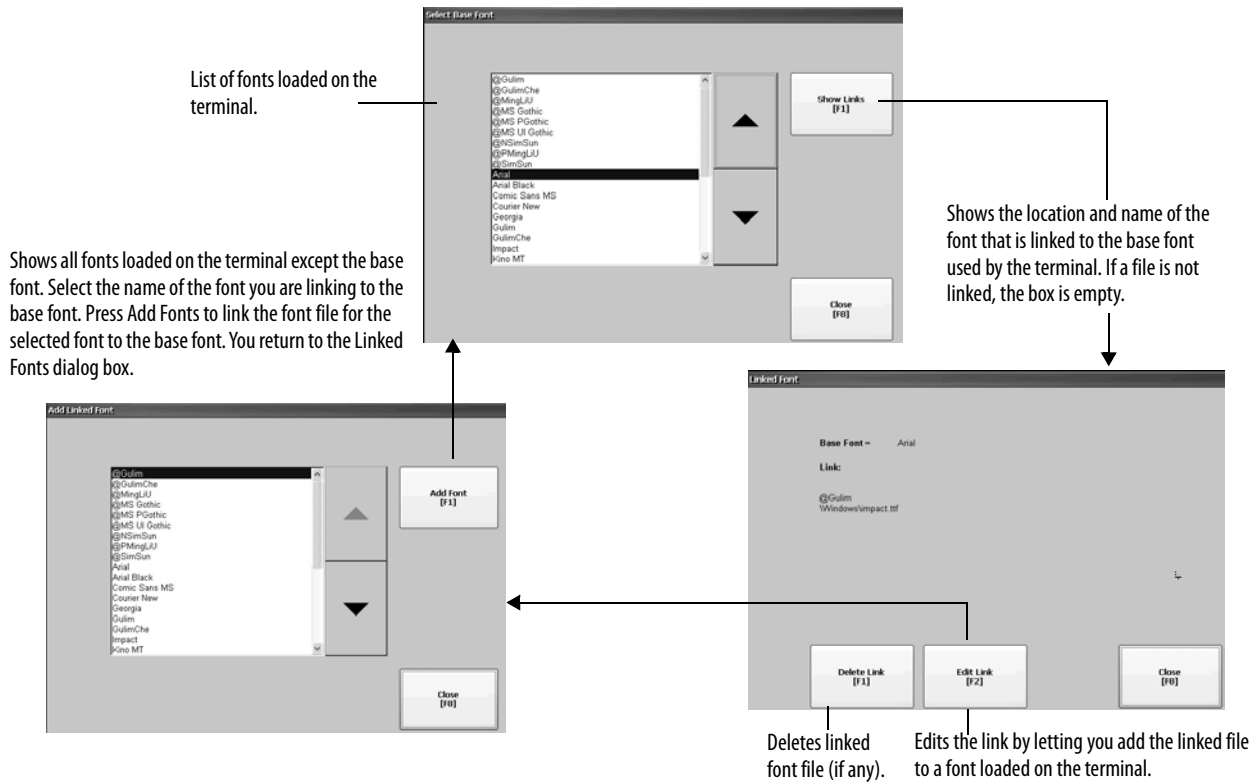

## Windows CE Operating System

Topic	Page
Windows CE 6.0 Standard Features	83
Windows CE 6.0 with Extended Features	85
Taskbar and Windows Explorer	86
Windows Control Panel	87
Backup and Restore	88
Hardware Monitor	91
Keypad Properties	93
Touch Properties	93
Display Properties	94
Logo Manager	96
System Information	97
User Accounts	97
Services	101
Network Server Configuration	102
Printer Support	111
PDF Reader	114

### Windows CE 6.0 Standard Features

The terminals run the Windows CE 6.0 operating system (OS) providing the following shell and user interface features:

- Command shell
- Command processor
- Console window
- Windows Explorer shell
- Mouse and touch screen support
- Common dialog box
- Control panel
- Network user interface
- Soft keyboard input panels
- PDF reader

- VNC server and client viewer

The platform distributes two VNC client viewers:

- Vncviewer.exe in the \Windows folder on the terminal can be deployed to a personal computer for connecting, viewing, and controlling the Windows CE terminal (PanelView™ Plus 6).
- Another viewer is available on the terminal to establish a VNC connection between two PanelView Plus 6 terminals. To access this VNC client, choose Start>Programs>VNC Viewer.

**TIP** The Windows Explorer shell supports right-click functionality. A touch screen press held for one second or longer produces a right-click.

## Application Support

The Windows CE 6.0 operating system provides application support in both the OS and the Software Development Kit (SDK):

- .Net Compact Framework, version 3.5 or later
- C++ libraries and runtimes
- Component services DCOM/COM/OLE
- Message queuing MSMQ
- MSXML, version 3.0 or later
- MFC for devices, version 8.0 or later
- ATL
- ActiveSync
- CAB file installer/uninstaller
- Toolhelp API
- Error reporting (generator, transfer driver, control panel)

## Scripting Support

The Windows CE 6.0 operating system supports these scripting features:

- Batch/command (BAT and CMD files)
- JScript
- VBScript
- CSScript

## Network Support

The Windows CE 6.0 operating system supports these network features:

- Winsock support
- Network utilities - ipconfig, ping, route
- Network Driver Architecture (NDIS)
- Windows Networking API/Redirector
- Wired Local Area Network, 802.3, 802.5

## Server Support

This table lists servers supported by the Windows CE 6.0 operating system.







**Table 47 - Windows CE 6.0 Server Support**

Server	Default State	Description
Web server	Enabled	The web server delivers content, such as web pages, by using the HTTP protocol over the Web.
FTP server	Enabled	File Transfer Protocol (FTP) is a standard network protocol for exchanging files over the Internet (TCP/IP-based network).
UPnP server	Enabled	Universal Plug and Play (UPnP) is a set of networking protocols that lets devices install and connect seamlessly to a network.
File Server	Disabled	A network protocol that provides shared access to files, printers, serial ports, and miscellaneous communication between computers on a network.
VNC server	Disabled	Virtual Network Computing (VNC) is a graphical desktop sharing system used to remotely control another computer. It transmits keyboard/mouse events from one computer to another, over a network.
ViewPoint Server	Enabled	Supported on PanelView Plus 6 - 700 to 1500 terminals. A web-server based application that provides remote user access via a web browser to the FactoryTalk View Machine Edition HMI application that is running on the terminal. ViewPoint software is a Rockwell Automation product.
	Disabled	Not supported on PanelView Plus 6 - 400 and 600 terminals.

## Windows CE 6.0 with Extended Features

Terminals and logic modules with extended features, catalog numbers 2711P-xxxxx9 and 2711P-RP9x, provide additional operating system components.

**Table 48 - Operating System with Extended Features**

Icon	Software	Icon	Software
	Microsoft Internet Explorer 6 web browser with Silverlight 2		Microsoft Office 2003 PowerPoint file viewer
	Adobe Flash Lite 3.1 ActiveX plug-in for Internet Explorer 6		Microsoft Office 2003 Word file viewer
	Microsoft Remote Desktop Connection <sup>(1)</sup>		Microsoft Office 2003 Excel file viewer
	Microsoft media player 6.4 and 7.0 OCX		Westtek JETCET PDF viewer
	Microsoft WordPad text editor		

(1) The remote desktop connection is not currently supported on PanelView Plus 6 - 600 terminals with extended features.

## Windows Explorer

From the desktop, you can access Windows Explorer in several ways:

- Open the My Device icon on the desktop.
- Choose Start>Programs>Window Explorer.

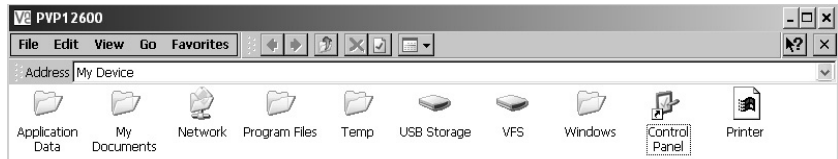

Besides the typical system folders, a few folders contain items specific to the PanelView Plus 6 terminals.

Folder	Content
Application Data	Contains FactoryTalk® View Machine Edition application files. Path: \Application Data\Rockwell Software\RSViewME
VFS (Virtual File System)	Contains firmware files and backup/restore files for the current system image. Path: \VFS\Platform Firmware

## Taskbar

The taskbar has icons to access the Start menu, terminal IP information, the current language and time, input panels, and open programs.

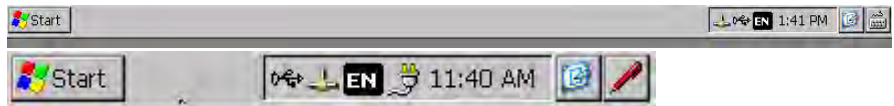

You can turn the taskbar on or off by choosing Start>Settings>Taskbar and Start Menu then checking or clearing the Auto Hide checkbox.

**TIP** On touch screen terminals, touch the bottom of the display to recover the taskbar in Auto Hide mode.

## Input Panels



Different soft keyboards or input panels are available for entering data. You can access these input panels from the taskbar:

- Keyboard and large keyboard
- CHT Chajei (Chinese)
- CHT Phonetic (Chinese)
- MS Kana (Japanese)
- MS Roma (Japanese)
- No IM - no input method selected (default)

**TIP** You can hide the view of an input panel from the taskbar by choosing the No IM option.

**TIP** On PanelView Plus 6 - 700 to 1500 terminals, you can also access the input panels from the control panel.

## Windows Control Panel

The Windows control panel is the desktop interface for configuring a terminal. You can set system-wide and terminal properties, such as network configuration, screen saver configuration, and touch screen calibration.

[Table 49](#) list the control panel applets. The language of the applets is based on the language set for the operating system. English is the default.

**TIP** Most terminal settings are available in FactoryTalk View ME Station.



You can access the control panel in several ways:

- Choose Start>Settings>Control Panel.
- Open My Device on the desktop, then open the Control Panel.

**TIP** Control panel dialogs on the 400/600 terminals have scroll bars for viewing.

**Table 49 - Availability of Control Panel Applets on Terminals**

Name	400/600	700 to 1500	Description
Accessibility	—	•	Adjusts your terminals settings for vision, hearing, and mobility.
Backup & Restore	•	•	Performs a backup and restore of an HMI terminal image.
Certificates	—	•	Manages digital certificates for establishing trust and secure communication.
Date and Time	— <sup>(2)</sup>	•	Sets the time, date, and time zone.
Dialing	—	•	Sets dialing patterns and location settings.
Display	•	•	Changes the wallpaper desktop appearances, backlight, screen saver, and visible cursor settings.
Error Reporting	—	•	Enables and configures software error reporting.
Hardware Monitor	•	•	Displays voltage and temperature information, and the system event log.
Input Panel	—	•	Configures the soft keyboard.
Internet Options <sup>(1)</sup>	•	•	Configures Internet Explorer settings.
Keyboard	— <sup>(2)</sup>	•	Configures an external USB keyboard.
Keypad	•	•	Configures the keypad on the terminal display (if one is present).
Logo Manager	•	•	Loads and applies a new image to the splash screen and screen saver on the HMI terminal.
Mouse	— <sup>(2)</sup>	•	Sets the USB mouse double-click properties.
Network and Dial-up Connections	•	•	Creates and configures direct, dial-up, VPN, and Ethernet connections.
Owner	—	•	Sets owner identification and security for device and remote network.
Password	—	•	Sets password and enables password protection for startup and Screen Saver mode.
PC Connection	—	•	Selects a connection between the device and a personal computer.
Printers	•	•	Adds and configures local and network printers.
Regional Settings	•	•	Selects the locale and sets the format of numbers, time, date, and currency.
Remove Programs	•	•	Uninstalls applications.
Server Config	•	•	Configures network servers: VNC, FTP, Web, File, KEPServer.
Services	•	•	Enables and disables services and servers.
Storage Manager	—	•	Reports information on storage devices. Scans, partitions, defragments, and mounts volumes.
System	•	•	Provides general system information. Sets and reports a device name and memory allocation/usage.
Terminal Server Clients <sup>(1)</sup>	—	•	Displays terminal server client access licenses for devices that connect to a terminal server.
Touch	•	•	Sets touch-screen properties, cursor, and calibrates touch screen (if one is present).
User Accounts	•	•	Manages user accounts for NTLM security.
Volume & Sound	—	•	Adjusts volume and sound properties for events, applications, and key clicks.

(1) Applies to PanelView Plus 6 terminals with extended features and file viewers.

(2) Settings for these properties are available in FactoryTalk View ME Station.

## Backup and Restore



The Backup and Restore application lets you back up the current system image on the HMI terminal, then restore that image to the same terminal, or clone it to other terminals. This function is intended for OEMs who want to back up a terminal image, then clone or copy that same image to multiple terminals.

A typical backup includes the following:

- File system
- Firmware image
- Windows registry

Additional user configuration data is included in the backup if you check Advanced Network & Display Settings.

**Table 50 - Advanced Network and Display Settings**

Network Parameters	Terminal Specific Parameter
Ethernet network	<ul style="list-style-type: none"> <li>• DHCP-enabled or fixed IP address with subnet mask and gateway</li> <li>• Primary and secondary DNS</li> <li>• Primary and secondary WNS</li> <li>• Speed and duplex settings</li> </ul>
USB network	USB IP address and subnet mask, Gateway, DHCP-enabled or fixed IP address
Network	Device name
Display	<ul style="list-style-type: none"> <li>• Display brightness</li> <li>• Screen saver dimmer timeout</li> </ul>

You can back up the terminal image to a file on a USB flash drive or SD card.

Follow these steps to perform a backup.

1. Insert a USB flash drive or SD memory card into the appropriate slot of the terminal.
2. In the control panel, double-click the Backup & Restore icon.
3. Click the browse ... button on the Backup tab.

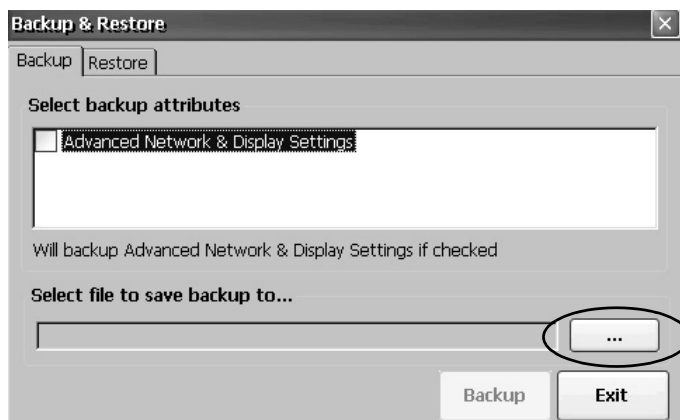

4. Select the location for the back-up file:
  - USB Storage if using a USB flash drive
  - Storage Card2 if using an SD card
  - Target folder if backing up to terminal
5. Type a name for the back-up file.  
All back-up files have the .pvb file type.
6. Click OK.

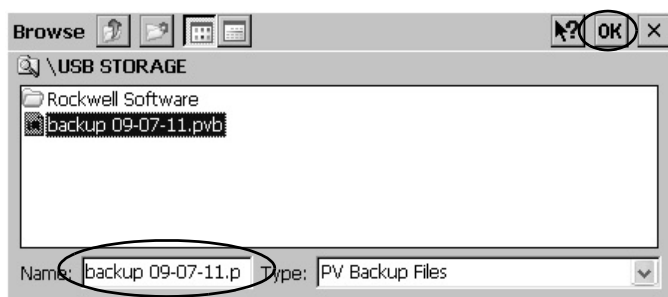



- Click Backup to start the process.

A progress bar shows the status of the backup.

The backup can take a few minutes. You receive notification when the backup completes successfully.



- Click OK.

If the file exists, you are asked if you want to overwrite the current file.

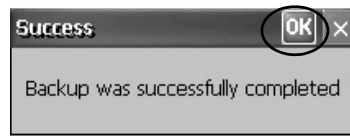

- Click Exit to close the Backup & Restore dialog box.

**TIP**

You can verify that .pvb file was successfully created by double-clicking My Device and selecting the target location for the backup.

Follow these steps to restore or clone a back-up image to a terminal from a USB flash drive or SD card.

- Insert the USB flash drive or SD memory card into the appropriate slot on the target terminal.
- In the control panel, double-click Backup & Restore.
- Click the Restore tab.
- Click the ... browse button to select the back-up file to restore.

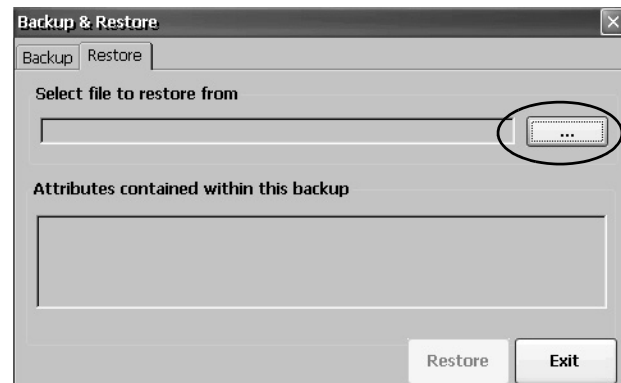

- Select the location of the back-up file:
  - USB Storage if using a USB flash drive
  - Storage Card2 if using an SD card
  - Target folder on terminal containing .pvb file

This example shows \USB Storage as the location.
- Select the .pvb back-up file to restore.
- Click OK.

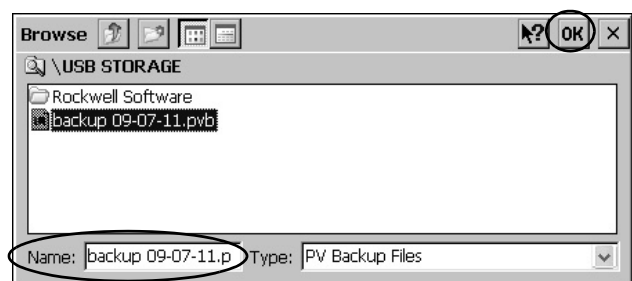

8. Click Restore.

The restore automatically includes advanced network and display settings if this option was checked when the backup was performed.



9. Click Yes to start the restore.

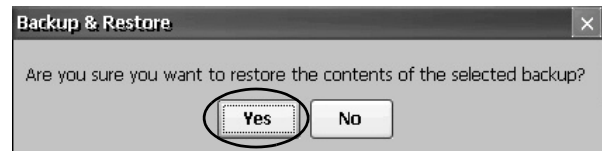

The terminal starts the restore process. This process can take a few minutes.

**IMPORTANT**

Do not remove the USB flash drive or SD card, or power off the terminal during the restore. This could corrupt the firmware.

If the restore fails, you need to reset the terminal from the maintenance menu.

Refer to [Access Maintenance Operations on page 170](#) for details.



When the restore has completed successfully, the terminal restarts.

## Hardware Monitor



The PanelView Hardware Monitor provides status and troubleshooting information for the terminals including running processes, system event log details, and monitoring of battery voltages, temperatures, and system usage, for example, CPU and memory loading.

### Processes

The Processes tab of the Hardware Monitor shows all processes currently running on the PanelView Plus 6 terminal and memory usage of each process.

ProcessName	ProcessId	Thr	BaseAddr	HeapSize	TotalMem	Commit	Reserved
NK.EXE	00400002	88	80225000	4169328	0	0	0
udevice.exe	01D20002	7	00010000	18400	2269184	1691648	577536
udevice.exe	01EC000A	1	00010000	2464	1814528	1630208	184320
udevice.exe	020F0002	1	00010000	4896	1814528	1630208	184320
udevice.exe	03020006	1	00010000	1536	1814528	1626112	188416
wt5portm.exe	0592000A	4	00010000	12160	2207744	1847296	360448
servicesd.exe	05F0000A	31	00010000	335088	5398528	2379776	3018752
RSLinxNG.exe	04FB001E	19	00010000	1292800	4907008	3211264	1695744
RSVCHost.exe	05EC00A2	13	00010000	108256	2789376	1900544	888832
udevice.exe	07660006	1	00010000	2560	1949696	1642496	307200
explorer.exe	07490596	6	00010000	51136	2691072	2019328	671744
fselect.exe	065A0696	1	00010000	2048	1818624	1630208	188416
CeVncServer.exe	04F10342	3	00010000	1132752	3252224	2838528	413696
control.exe	077B0092	1	00010000	22688	1818624	1667072	151552

Memory load 3766894592/320880640 [9%]

### System Event Log

The System Event Log tab of the PanelView Hardware Monitor displays warnings, errors, and events logged by the terminal.

Type	Date	Time	Category	MsgId	Message
Information	10/20/2010	12:36:19 AM	PVP	16777218	SYSMON: System boot. Reason: Normal
Information	10/20/2010	12:35:59 AM	None	65539	Microsoft (R) Windows CE (R) 6.00.0000
Information	10/20/2010	12:35:59 AM	None	65540	The Event log service was started.
Information	10/20/2010	12:23:58 AM	PVP	16777218	SYSMON: System boot. Reason: Normal
Information	10/20/2010	12:23:55 AM	PVP	16777218	SYSMON: Factory reset requested by
Information	10/20/2010	12:23:55 AM	PVP	16777218	SYSMON: NEW registry created by OS ver
Information	10/20/2010	12:21:57 AM	None	65539	Microsoft (R) Windows CE (R) 6.00.0000
Information	10/20/2010	12:21:57 AM	None	65540	The Event log service was started.

Cpu load 72%

The log provides a date and time stamp of when each event occurred and text describing the event. The maximum size of the log is 1 MB, approximately 4,000 records. If the log exceeds 1 MB, the oldest 512KB of information is removed:

- The Export Log button lets you export the event log to a CSV file (\*.csv) in the \Windows folder with the default file name, SystemLog.csv.
- The Clear Log button lets you clear all events from the log.
- The Details button lets you view more details for a selected event.

## Monitors

The Monitors tab of the PanelView Hardware Monitor provides continuous voltage, temperature, and load information for the terminal.

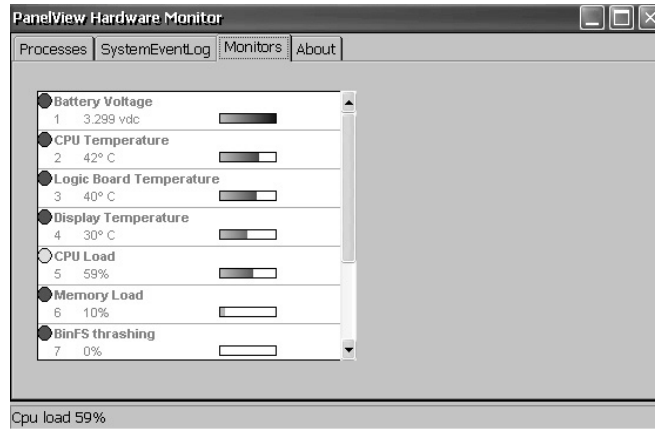

### Battery Voltage

The Monitors tab gives a visual status and voltage reading of the battery for the real-time clock. The battery voltage is updated at powerup and then every hour.

**Table 51 - Battery Conditions**

Condition	Logic Module Battery
Depleted	Less than 2.0V indicates a dead battery or no power.
Low	2.0...2.74V
Normal	2.75V or higher

### Temperatures

The Monitors tab provides a visual status and current temperature of the CPU, logic board, and terminal display. The temperature is updated every 10 seconds.

**Table 52 - Temperature Conditions**

Condition	Logic Board	CPU <sup>(1)</sup>	Display <sup>(1)</sup>
Low	—	—	10 °C (50 °F) or lower
Normal	25...94 °C (77...201 °F)	25...94 °C (77...201 °F)	11...59 °C (52...138 °F)
High	95 °C (203 °F) and higher	95 °C (203 °F) and higher	60 °C (140 °F) and higher

(1) The CPU and display temperatures do not apply to the 400 and 600 terminals.

## Keypad Properties



Use the Keypad and Keyboard dialog boxes to adjust settings for the membrane keypad of your terminal or an attached USB keyboard. The Keyboard applet is always present. The Keypad applet appears only if your device has a keypad. If you attach two USB keyboards, settings are used that work with both keyboards.

### Repeat Tab

The Repeat tab on the Keypad or Keyboard Properties dialog box controls the character repeat behavior of keys on the keypad or attached keyboard.

When character repeat is enabled, you can set the repeat delay and repeat rate of keys. Verify your settings by pressing a key in the test edit box.

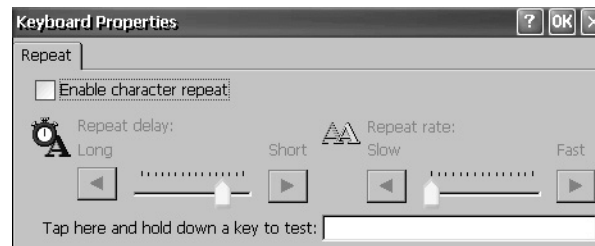

## Touch Properties



Touch Properties is accessible only on devices with a touch screen. It lets you calibrate the touch screen and set the sensitivity of touch screen taps.

### Calibration

The Calibration tab lets you recalibrate the touch screen if your device is not responding appropriately to taps. Follow the instructions in the dialog box to recalibrate.

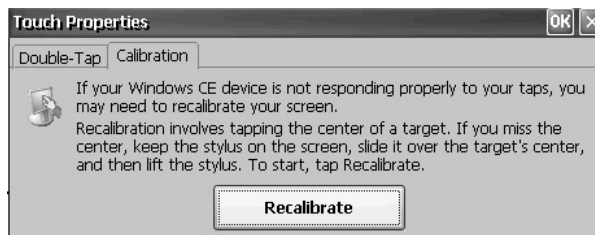

### Double-Tap

The Double-Tap tab on the Touch Properties dialog box lets you set and test the double-tap sensitivity of the touch screen taps.

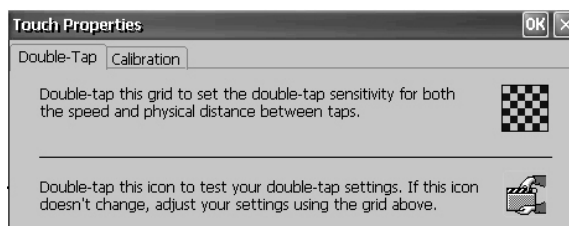

## Display Properties



Use Display Properties to control the desktop background image and appearance, the brightness of the backlight, and screen saver settings.

### Desktop Background

The Background tab in Display Properties controls the background bitmap on the desktop. The default bitmap is abclocknight.



You can select another image from the pull-down menu or browse the system for a bitmap image. Custom images are in the \Windows folder.

### Desktop Appearance

The Appearance tab in Display Properties controls the visual style and colors of the desktop and other window elements.

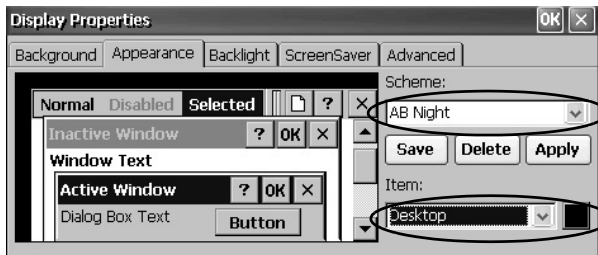

Two custom schemes and images are provided for day or night viewing. When changing schemes, remember to also change the image on the Background tab.

Scheme	Desktop Color	Background Logo
AB Day	Blue	abclocknight
AB Night	Black	abclockday

### Backlight Intensity

The Backlight tab in Display Properties lets you set the brightness level of the display between 1...100%. At 1%, the display is minimally visible.

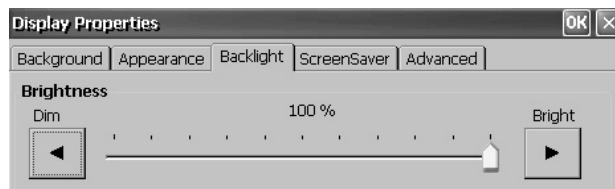

When the backlight is in Overdrive mode, the brightness cannot be adjusted. Refer to [View the Display Temperature on page 65](#) for more details.

## Screen Saver

The screen saver extends the lifetime of the display by dimming the backlight when the terminal is idle. The screen saver activates and displays a moving bitmap at a reduced brightness level after a continuous idle time. When the screen saver is deactivated, the display brightness returns to its normal level.

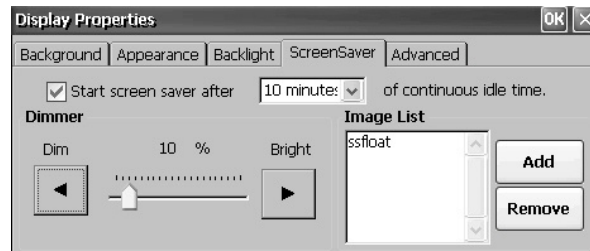

The Screen Saver tab in Display Properties lets you perform these operations:

- Enable the screen saver by using a specified idle timeout. The default idle time is 10 minutes.

When the screen saver is activated, the dimmer controls the backlight intensity level. You set the brightness level of the dimmer in the range 0...100%. The default dimmer intensity is 10%. At 0%, the backlight is off and the display is dark.

- Browse the system for a bitmap to be displayed by the screen saver at a nonzero brightness level. The default screen saver is SSFloat.bmp. Click Add or Remove to change the screen saver bitmap. The system recognizes bitmaps stored in the \Windows folder.
- Disable the screen saver by clearing the Start screen saver checkbox.

## Cursor, Rotation, and Color Depth

The Advanced tab in Display Properties lets you perform these operations:

- Enable or disable the visible cursor that you see on the display. The cursor is visible by default.
- Rotate the screen on the terminal. The default is 0 degrees.
- Specify the color depth of the display. The default is 32 bits per pixel (bpp).

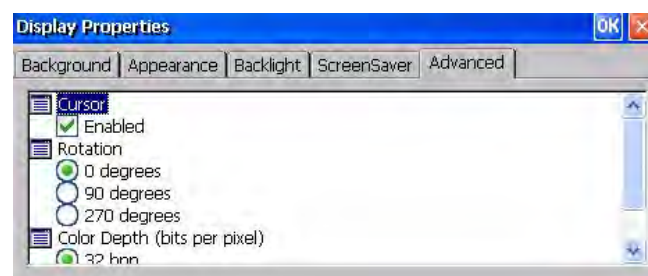

## Logo Manager



Use the Logo Manager to change the logo that appears on the splash screen at startup and the default screen saver image. The default image is the Allen-Bradley logo (ablogo.bmp).

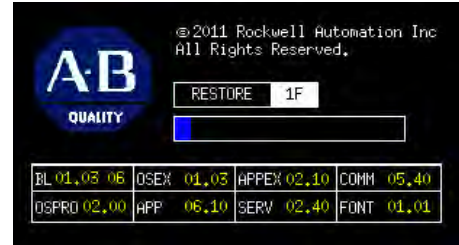

The logo can be a .bmp, .jpg, .gif, or .png image. For best results, it is recommended that the logo be created as a 90 x 90 pixel, 16-bit color image.

Before applying the new logo, you can do the following:

- Preview the logo on the splash screen.
- Resize the image to fit the fixed area on the splash screen.

Follow these steps to apply a new logo to the splash screen and screen saver.

1. Double-click the Logo Manager icon.  
The Logo Manager opens with the current logo.
2. Click Load.
3. Select the location of the new image you want to load:
  - A folder
  - Storage Card2 - SD card
  - USB Storage - USB drive
4. Select the image file to load.
5. Verify the file type is correct.
6. Click OK.

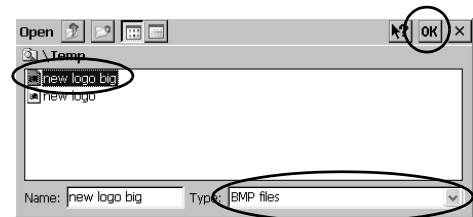
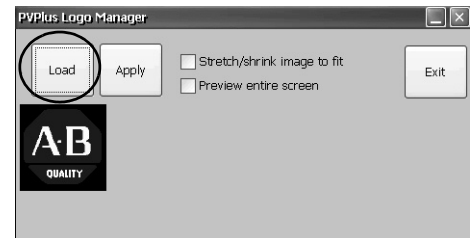

The new logo appears in the Logo Manager dialog box.

7. Check 'Preview entire screen' to view the logo on the splash screen.

If the logo is truncated or too small, check 'Stretch/shrink image to fit' to resize the logo to fit in the area.

8. If satisfied with the preview, click Apply.

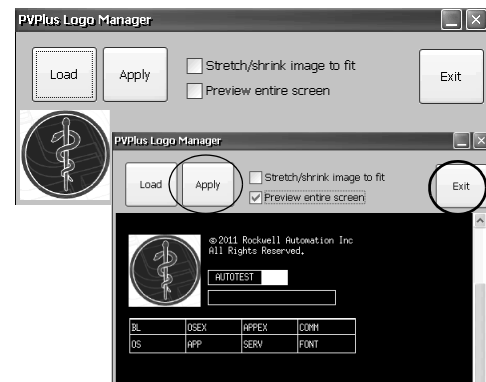

A dialog box confirms the splash screen was successfully updated. The default screen saver, sfloat.bmp, is also updated with the new image.

9. Click OK, then click Exit to close the Logo Manager.



## System Information

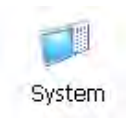

The System Information dialog provides tabs to let you view and set system-wide properties for your terminal.

### General Information

The General tab of the System Information dialog box shows the current version of the Windows CE operating system, the processor type and speed, and RAM memory on terminal.



### Startup Options

The Startup Options tab in the System Information dialog box lets you set these options at startup:

- Show or hide battery warning
- Launch the platform as open or closed system
- Disable or enable Safe mode request
- Show or hide system watchdog errors



### Battery Warnings

If the battery is low, missing, or dead, a warning displays each time the terminal starts up.

- TIP**
- The terminal can be operated without a battery if it is not required that the time and date be accurate.
  - When replacing the battery, you can verify the accuracy of the system date and time from the control panel or the terminal settings in FactoryTalk View ME Station Configuration mode.



You have three options for handling the battery warning.

Battery Warning Start-up Options	Description
Always show at startup (continue with startup)	Shows the battery warning at startup with FactoryTalk View ME Station software running behind it. This is the default.
Always show at startup (halt startup)	Shows the battery warning at startup but halts the startup or boot process until you press OK.
Never show at startup	Hides the battery warning at startup.

### Shell Options

Use the Shell options to launch an open or closed desktop at startup or to set the visual appearance of button controls.



Shell Startup Options	Description
System Type	<p>Launches the terminal as an open or closed system at startup:</p> <ul style="list-style-type: none"> <li>Open - launches the Windows CE desktop on startup.</li> <li>Closed (default) - launches FactoryTalk View ME Station Configuration mode on startup.</li> </ul> <p>You can also allow or restrict desktop access within FactoryTalk View ME Station Configuration mode by pressing Terminal Settings&gt;Desktop Access Setup. Refer to <a href="#">Desktop Access on page 52</a>.</p>
User Interface Button Controls	<p>Sets the visual appearance of control buttons at startup:</p> <ul style="list-style-type: none"> <li>Windows XP Style (default)</li> <li>Windows 95 Style</li> </ul>

### Boot Option

The boot option provides a way for you to enter Safe mode at startup.



Safe Mode Option	Description
Do not detect Safe mode request at startup	Disables Safe mode detection during startup. This is the default.
Detect Safe mode request at startup	<p>Displays a small white box in the lower left corner of the terminal display during startup that you can touch or press F1 to enter Safe mode. This lets you bypass a loaded FactoryTalk View ME application and go directly to Configuration mode. If you don't press F1 or touch the white box, the system boots up normally.</p> <p>Another way to enter Safe mode is to access Maintenance mode. Refer to <a href="#">Access Maintenance Operations on page 170</a>.</p>

## Watchdog Errors

You can show or hide watchdog errors at startup.



Watchdog Error Options	Description
Always show watchdog errors at startup	Shows the fatal watchdog error (error 02) at startup and halts the normal boot process. This is the default. The system launches the maintenance window with the watchdog error displayed. You can continue booting from this window. Refer to <a href="#">Access Maintenance Operations on page 170</a> for details. The error is logged to the System Event log.
Never show watchdog errors at startup	Hides the errors at startup and logs the error to the system event log.

## Advanced Diagnostics

Advanced diagnostics are for technical support use to diagnose and resolve system errors. They are not for use in a normal production environment.



## Device Name

The Device Name tab of the System Information dialog box identifies your terminal to other devices on the network by providing a device name and description.

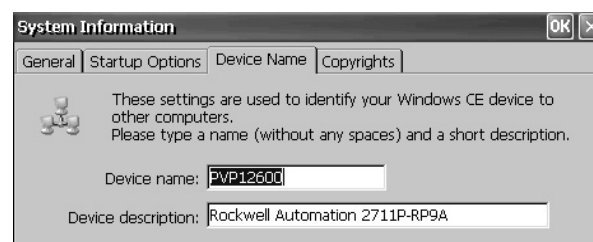

**TIP** Duplicate names conflict and cause network problems.

## User Accounts



The User Accounts application lets you set up NTLM user accounts that can be used to authenticate client connections when using the FTP, web, and file servers.

**TIP** NTLM is the authentication protocol used on networks that run Windows operating systems.

A user account consists of a user name and password.

Follow these steps to add a user account.

1. Double-click the User Accounts icon.

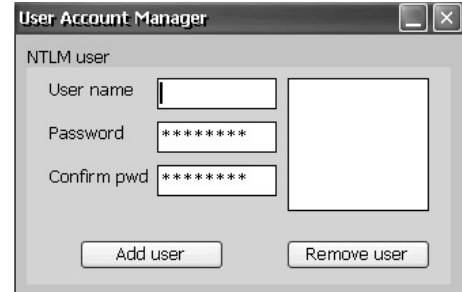

2. Click in the user name field and type a name.

3. Click in the Password field to clear the field and type a password.

Asterisks display as you type the password.

4. Re-enter the password in the Confirm pwd field.
5. Click Add user.
6. Click OK to acknowledge the new user account.

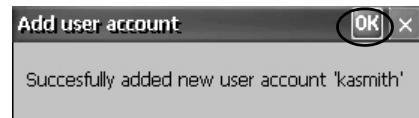
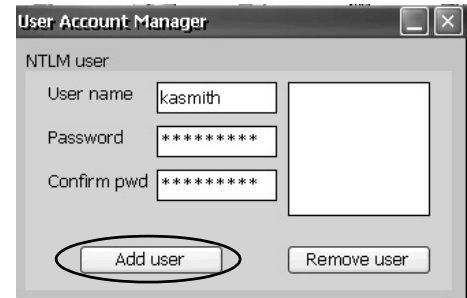

The new user name is added to the user list.

7. Repeat steps 1...6 to add additional user accounts.
8. When done, click X to close the dialog box.

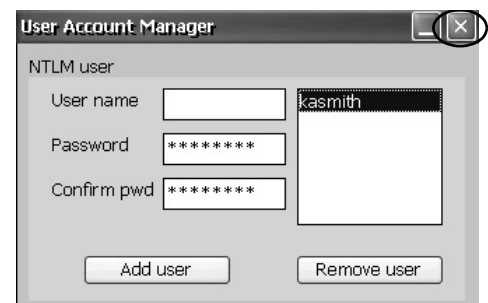

Follow these steps to remove a user account.

1. Select a name in the user name list.
2. Click Remove user.



3. Click Yes to confirm the removal of the selected user account.

The user account is permanently deleted from the user account list.



4. Close the User Account Manager by clicking x.

**TIP** Users entered in authentication lists of FTP, web, or file server configurations are removed when user accounts are deleted.

## Services



The Services application shows servers that are supported by the terminal and lets you enable (start) or disable (stop) each server. The ViewPoint server is not supported on the 400 and 600 terminals and appears red.



The buttons are color coded:

- Green indicates the server is currently running and automatically started at system startup.
- Red indicates the server is not currently running.
- Gray indicates the server is not available on platform.

To enable or disable a server, press the corresponding button and the color changes accordingly.

## Network Server Configuration



The Server Config applet in the control panel configures settings used for VNC, web, FTP, file server, and KEPServer activities on an Ethernet network.

### VNC Server Configuration

The VNC Server tab in the Network Server Configuration dialog box configures settings used by a client device to view or control the terminal over a VNC connection. The VNC service supports two concurrent client connections.

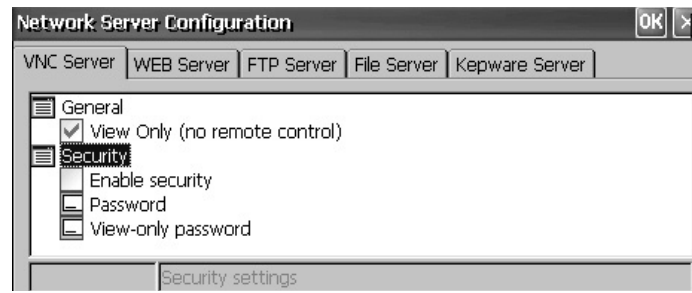

**TIP** Always click OK to apply new settings. You are asked if you want to restart the service immediately.

The terminal provides two VNC client viewers:

- Vncviewer.exe can be deployed to a personal computer for connecting, viewing, and controlling the VNC server on the terminal. This viewer is in the \Windows folder.
- Another VNC viewer is available on the terminal to establish a VNC connection between two PanelView Plus terminals. To access this client, choose Start>Programs>VNC Viewer.

**Table 53 - VNC Server Parameters**

VNC Parameter	Description	Default
General		
View Only	Check this option to let users view terminal displays over a VNC connection. Uncheck this option to let users both control and view terminal displays over a VNC connection. If security is disabled, users are not required to enter a password when connecting to the terminal.	Enabled for view only
Security		
Enable Security	Check this option to require password protection for VNC connections to the terminal. This means users must enter a valid password before viewing or controlling terminal displays. If you enable security, you must supply a password for one of these parameters: <ul style="list-style-type: none"> <li>• Password - for control and view operations</li> <li>• View-only password - for view only operations</li> </ul>	Disabled (Unchecked)
Password	Specifies a password a user must enter when establishing a VNC connection to control terminal displays. Select the box, then type a password in the field at the bottom of the dialog box. The password is a maximum of seven characters. Password protection is required to control terminal displays if: <ul style="list-style-type: none"> <li>• View Only is unchecked (allowing control access)</li> <li>• Security is enabled</li> </ul>	No password
View-only password	Specifies a password a user must enter when establishing a VNC connection to view terminal displays. Select the box, then type a password in the field at the bottom of the dialog box. The password is a maximum of seven characters. <b>TIP:</b> If you uncheck the View Only parameter, you have control and view access to the terminal. With control access enabled, you can restrict one or more users to view-only access by providing a View-only password. View-only password protection is required to view terminal displays if security is enabled: <ul style="list-style-type: none"> <li>• View Only is checked or unchecked</li> <li>• Security is enabled</li> </ul>	No password

### VNC Connection Requiring Password for View-only Operations

The default VNC configuration enables view-only access to the terminal without requiring a password. This applies to the VNC viewer that resides on the terminal and the viewer you can deploy to a computer.

This example uses the VNC viewer deployed to a computer to connect to the HMI terminal.

**TIP** Copy `vnviewer.exe`, in the `\Windows` folder on the terminal, to your computer and install the TightVNC software.

Follow these steps to configure a VNC connection that requires a password to view terminal operations.

1. On the VNC Server tab, check the following:
  - View Only
  - Enable security
2. Select View-only password, then enter a seven-character password in the field that opens.
3. Click OK, then restart the service to apply the new settings.

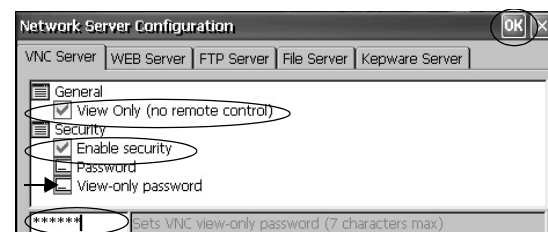

Follow these steps to launch a VNC connection to view terminal operations.

1. From your computer, choose Start>Programs>TightVNC>TightVNC Viewer.
  2. Enter the IP address of your terminal and click Connect.
- Click the network connection icon in the system tray to view the IP address.

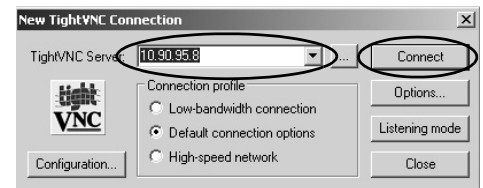

**TIP** If security is disabled, a password is not required.

3. Enter the View-only password defined in the VNC configuration and click OK.

The PanelView VNC Server opens the current view of the HMI terminal on your desktop. You can view, but not control terminal operations.



4. When finished, close the PanelView VNC Server.

### VNC Connection with Separate Passwords for View and Control Operations

You can configure the VNC server to require separate passwords for view-only and control operations.

This example uses the VNC viewer deployed to a computer to connect to the HMI terminal.

**TIP** Copy vncviewer.exe, in the \Windows folder on the terminal, to your computer and install the TightVNC software.

Follow these steps to configure the VNC server to require a password for view-only and control operations.

1. On the VNC Server tab, do the following:
  - Clear View Only
  - Check Enable security
2. Select Password, then enter a password for control privileges.

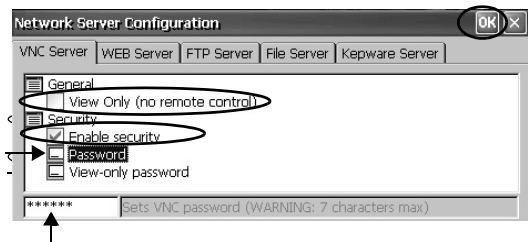

Passwords are a maximum of seven characters.

3. Select View-only password and enter a password for view-only privileges.
4. Click OK, then restart the service to apply the new settings.

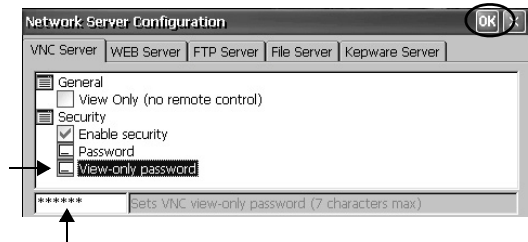

Follow these steps to launch a VNC connection to enable control of the terminal.

**TIP** To launch a VNC connection from your computer that requires password protection for view-only operations, refer to [page 103](#) and follow steps 1 . . . 4.

1. From your computer, choose Start>Programs>TightVNC>TightVNC Viewer.
2. Click Options.

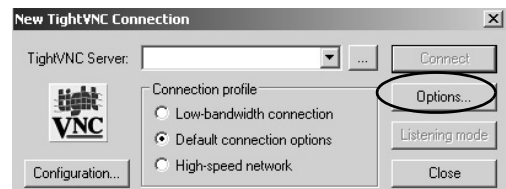



3. Clear View only (inputs ignored).

4. Click OK.

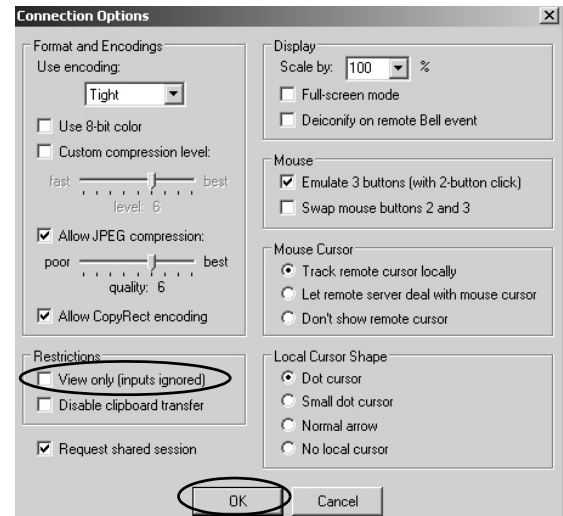

5. Enter the IP address of your terminal and click Connect.



Click the network connection icon in the system tray to view IP information.

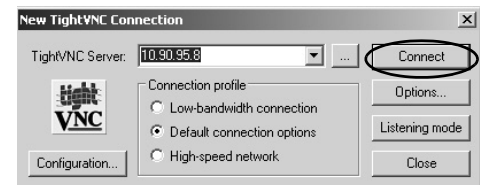

The Standard VNC Authentication dialog box opens.

6. Enter the control password that was defined in the VNC configuration dialog box on the terminal and click OK.

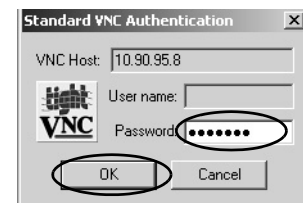

The PanelView VNC viewer opens.

7. On your computer, perform some actions to verify that you have control of the terminal.

8. When finished, close the PanelView VNC Server.

## Web Server Configuration

The Web Server tab in the Network Server Configuration dialog box configures settings that are used for HTTP web activities. These are standard Microsoft Windows CE parameters.

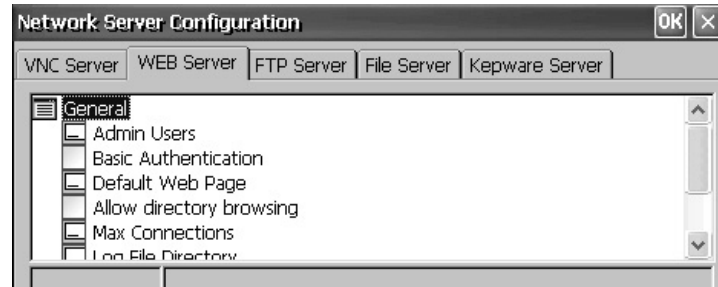

**TIP** Always click OK to apply new settings. You are asked if you want to restart the service immediately.

**Table 54 - Web Server Parameters**

Parameter	Description	Default
Admin Users	Specifies a list of users allowed to administer web activities. When selected, you can enter a list of user names, separated by semicolons, in the field that opens at the bottom of the dialog box.	ADMIN
Basic Authentication	Check this option to require a user name and password to access the web server.	Disabled (unchecked)
Default Web Page	Specifies default web pages users can access.	default.htm;index.htm
Allow Directory Browsing	Check this option to let users browse directories on a web server.	Disabled (unchecked)
Max Connections	Specifies the maximum number of incoming web connections.	256
Log File Directory	Specifies the path where the log file is stored. This file logs web activity.	\windows\www
Max Log Size	Specifies the maximum size of the log file stored in the log file directory. A new log file is created, when the current log file reaches the maximum size.	32768 bytes
NTLM Authentication	Check this option to require a valid user name and password to access the web server. If NTLM Authentication is enabled, you must enter a valid user name in the Admin Users field. NTLM user accounts are defined in the User Account Manager of the control panel.	Enabled (checked)

## FTP Server Configuration

The FTP Server tab in the Network Server Configuration dialog box configures settings that are used for exchanging files over a network. These are standard Microsoft Windows CE parameters.

The default FTP configuration lets any user establish an FTP connection to the HMI terminal by logging in anonymously and downloading files from the FTP default directory (\Temp).

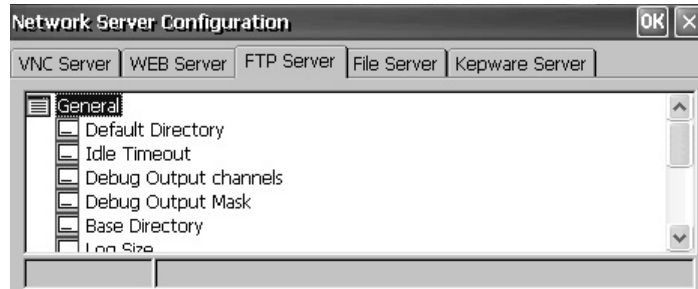

**TIP** Always click OK to apply new settings. You are asked if you want to restart the service immediately.

**Table 55 - FTP Server Parameters**

FTP Parameters	Description	Default
<b>General</b>		
Default Directory	Specifies a file storage location on your HMI terminal for transferring files. This is the directory that users come to when they first connect to the FTP server.	\Temp\
Idle Timeout	Specifies the time in seconds after which inactive control connections are closed during a data transfer. An FTP session requires one control connection, plus one data connection during file transfers. Without a timeout, the FTP server process can be left pending indefinitely if the corresponding client crashes without closing the control connection.	300 seconds (5 minutes)
Debug Output Channels	Specifies the number of debug output channels.	2
Debug Output Mask	Specifies the port number of the output mask used for debugging.	23
Base Directory	Specifies the path where the FTP log file and other support files are stored.	\Windows
Log Size	Specifies the maximum size of the file that logs FTP activities. The log file is stored in the base directory. A new log file is created, when the current log file reaches the maximum size.	4096 bytes
<b>Security Parameters</b>		
Use Authentication	Check this option to require a valid NTLM user name and password to access the FTP server. If authentication is enabled, you must enter one or more valid user names in the User List field. NTLM user accounts are defined in the User Account Manager of the control panel.	Enabled (checked)
Allow Anonymous Logins	Check this option to let anyone connect to the ftp server. Anonymous logins do not require a user name and password.	Enabled (Checked)
Allow Anonymous Uploads	Check this option to let users logged in anonymously to upload (or write) files to the FTP server (or default directory). If unchecked, users logged in anonymously can download (or copy) files from the server.	Disabled (Unchecked)
Allow Anonymous VRoots	Check this option to let users logged in anonymously to access virtual roots.	Disabled (Unchecked)
User List	Specifies which NTLM users can access the ftp server and exchange files to or from the default directory. When selected, you can enter a list of NTLM user names, separated by semicolons, in the field that opens at the bottom of the dialog box. User names and passwords are defined in the User Account Manager of the control panel.	None

### FTP Anonymous Login and Upload

Follow these steps to establish an FTP connection to the terminal by allowing anonymous logins and file transfers to or from the default FTP folder on the terminal.

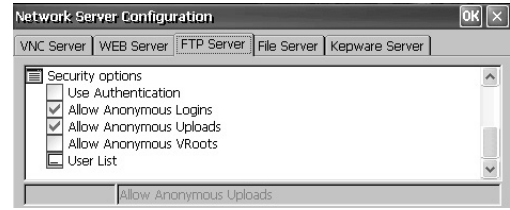

**TIP** If Allow Anonymous Uploads is not checked, you can copy files from the default FTP folder on the terminal but not to the folder.

1. Open your web browser or any folder on your computer.



**TIP** You need the IP address of your HMI terminal to establish an FTP connection. Click the network connection icon in the system tray to view IP information.

2. Type the IP address of the terminal in the address field by using the syntax ftp://ipaddress\_of\_hmi\_terminal.

ftp://90.95.80.8

An anonymous connection is established to the \Temp folder, which is the FTP default directory on the terminal. The folder shows two files.

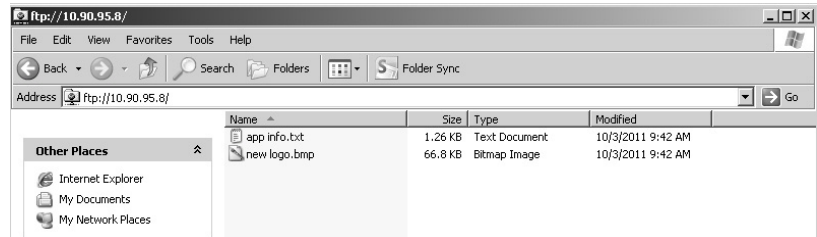

If you launch the FTP connection from your browser, you might see this view.



To see the folder view, click Page, then from the File menu, choose Open FTP site in Windows Explorer.

3. Transfer files between your computer and the FTP folder:
  - Drag or copy a file from the FTP folder to your computer.
  - Drag or copy a file to the FTP folder from your computer.

### FTP Connection Requiring User Authentication

Follow these steps to establish an FTP connection to the terminal by first entering a valid user name and password.

1. Open your web browser or any folder on your computer.
2. Type the IP address of the HMI terminal in the address field by using the syntax ftp://ipaddress\_of\_hmi\_terminal.  
ftp://90.95.80.8
3. Click OK when you see the FTP Folder Error dialog box.

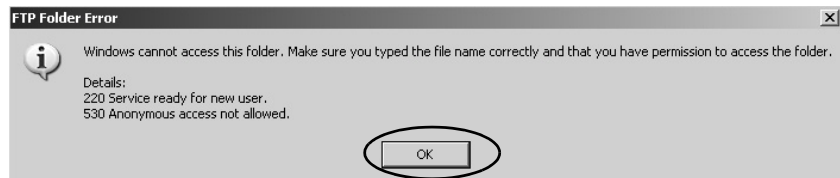
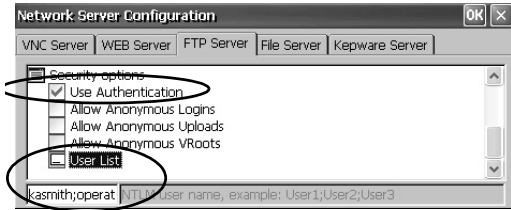

If you launch the FTP connection from your browser, a prompt can appear notifying you that Internet Explorer cannot display this web page. Choose Page>File>Open FTP site in Windows Explorer.

4. From the File menu, choose Login As.

The user name field is populated with the first user name entered in the User List of the FTP configuration.

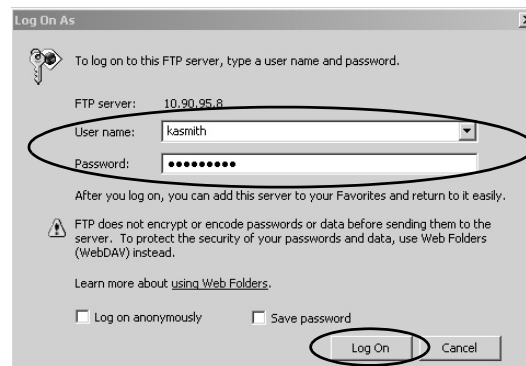

**TIP** The user name you enter must be in the User List of the FTP configuration and previously set up as a valid account in the User Accounts application.

5. Type a valid user name and password, then click Log On.

The default FTP directory on the terminal opens. You can transfer files to or from this folder.

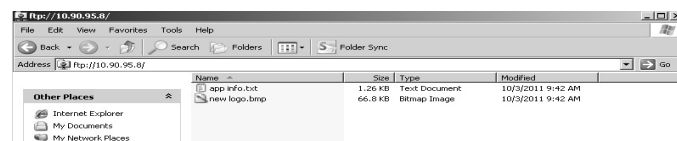

## File Server Configuration

The File Server tab in the Network Server Configuration dialog box provides settings that allow shared access to files, printers, serial ports, and miscellaneous communication between computers on a network. These are standard Microsoft Windows CE parameters.

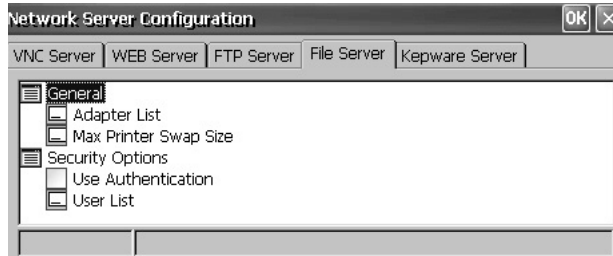

**TIP** Always click OK to apply new settings. You are asked if you want to restart the service immediately.

**Table 56 - File Server Configuration**

Parameter	Description	Default
General		
Adapter List	Provides a list of valid adapters.	* (all adapters)
Max Printer Swap Size	Specifies the maximum size of the printer swap file.	4096 bytes
Security Options		
Use Authentication	Check this option to require a valid NTLM user name and password to access the file server. If authentication is enabled, you must enter one or more valid user names in the User List field. NTLM user accounts are defined in the User Account Manager of the control panel.	Disabled (unchecked)
User List	Specifies a list of valid NTLM users allowed to access the file server. When selected, you can enter a list of NTLM user names, separated by semicolons, in the field that opens at the bottom of the dialog box. User names and passwords are defined in the User Account Manager of the control panel.	None

## KEPServer Configuration

The KEPServer tab in Network Server Configuration lets you select Kepware communication drivers for a connected device.

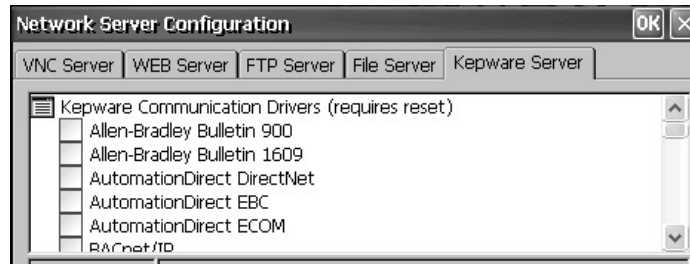

**TIP** Always click OK to apply new settings. You are asked if you want to restart the service immediately. You must also reset your terminal.

## Printer Support

The terminals supports selected USB printers such as Canon, Epson, Hewlett-Packard, and Brother. Automatic printer installation that uses plug-and-play capabilities is supported as well as manual installation if a suitable printer driver is available. You can connect a printer to a USB port on the terminal.

For more information on supported printers, go to the knowledgebase at <http://www.rockwellautomation.com/support/> and search for ID 111636 in the Search Answers box.

Printers are configured and managed from Printers in the desktop control panel. A wizard is supported for each printer type.

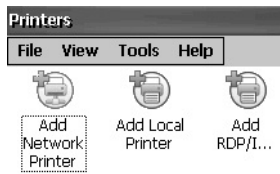

**Table 57 - Support for Printers**

Printer Type	Description
Local USB	You can connect a JETCET supported printer to a USB host port. The printer attached to the USB host port can be shared by a remote terminal when configured as a network printer on the remote terminal.
Network	The terminal supports a remote printer connected to the network via the Ethernet port. The printer can be addressed by its device name or IP address.
RDP /ICA	A local printer can be made available to a Windows server application that is running in an RDP (Remote Desktop Protocol) session on the terminal. <sup>(1)</sup>

(1) Applies only to PanelView Plus 6 terminals with extended features.

After configuring a printer, you can access it from desktop applications or from FactoryTalk View ME Station Configuration mode by pressing Terminal Settings>Print Setup. Applications can also select and share printers.

## Automatic Printer Installation

Follow these steps to install a plug-and-play printer from the Windows desktop. For manual printer installation, refer to [page 113](#).

**TIP** The procedure illustrates automatic plug-and-play installation for the Hewlett Packard HP deskjet 5650 printer.

1. Connect the printer to a USB host port on the terminal.
2. Plug the power cord of the printer into an outlet and turn the printer on.

Windows detects your plug-and-play printer and, in many cases, installs it without requiring you to make any selections.

The printer is ready to print.

---

**IMPORTANT** If automatic plug-and-play installation is not supported for a printer, this error is logged to the System Event log in the Hardware Monitor. 'JETCET PRINT was unable to auto-configure printer. To manually configure printer, go to the Printers folder from the Control Panel.'

---

3. Verify printer installation from the desktop control panel by opening the Printers applet.

Notice the icon for the Deskjet 5650C printer. The check mark indicates this is the default printer.

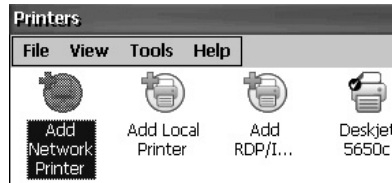

4. From the File menu, choose Properties to view the properties of the printer.

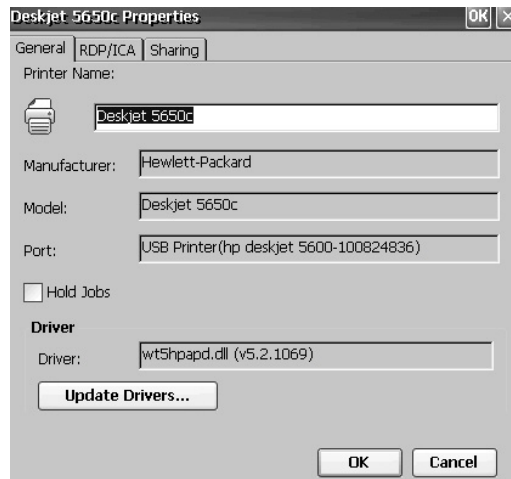

Printer configuration includes the printer name, manufacturer and model, printer driver, and port-specific parameters.

- TIP**
- New printer configurations are retained through a power cycle.
  - Printers set up through the desktop control panel are also available within FactoryTalk View ME Station configuration mode when by pressing Terminal Settings>Print Setup.

5. Right-click the printer and print a test page to verify installation.

When printing from an application such as WordPad, a Print dialog box opens where you can adjust print settings as needed.

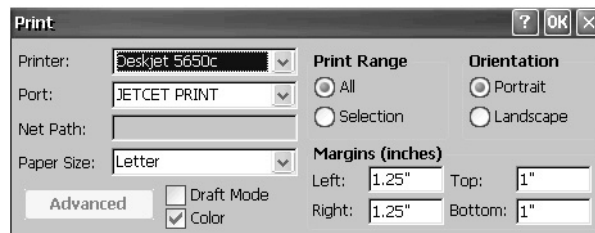



## Manual Printer Installation

Follow these steps to manually set up a supported printer.

1. Connect the printer to the USB port.
2. Plug the power cord of the printer into an outlet and turn the printer on.
3. From the desktop control panel, open Printers.
4. Click Add Local Printer.



5. Follow the Add Local Printer Wizard instructions to configure the printer:
  - a. Verify the connected printer appears on the USB printer port.
  - b. Select the manufacture and model of the JETCET printer.
  - c. Accept the default printer name or enter another.
  - d. Print a test page to verify the installed printer.
  - e. Specify whether you want the printer to be shared on the network.

# PDF Reader



A PDF reader is available on all PanelView Plus 6 terminals and provides typical PDF view and search functions. You can run this reader from the Windows desktop or from a command prompt.

When viewing a PDF document, you can initiate functions from the menu or toolbar. Bookmarks created in the original PDF appear under Bookmarks.

**Figure 13 - PDF Reader Workspace**

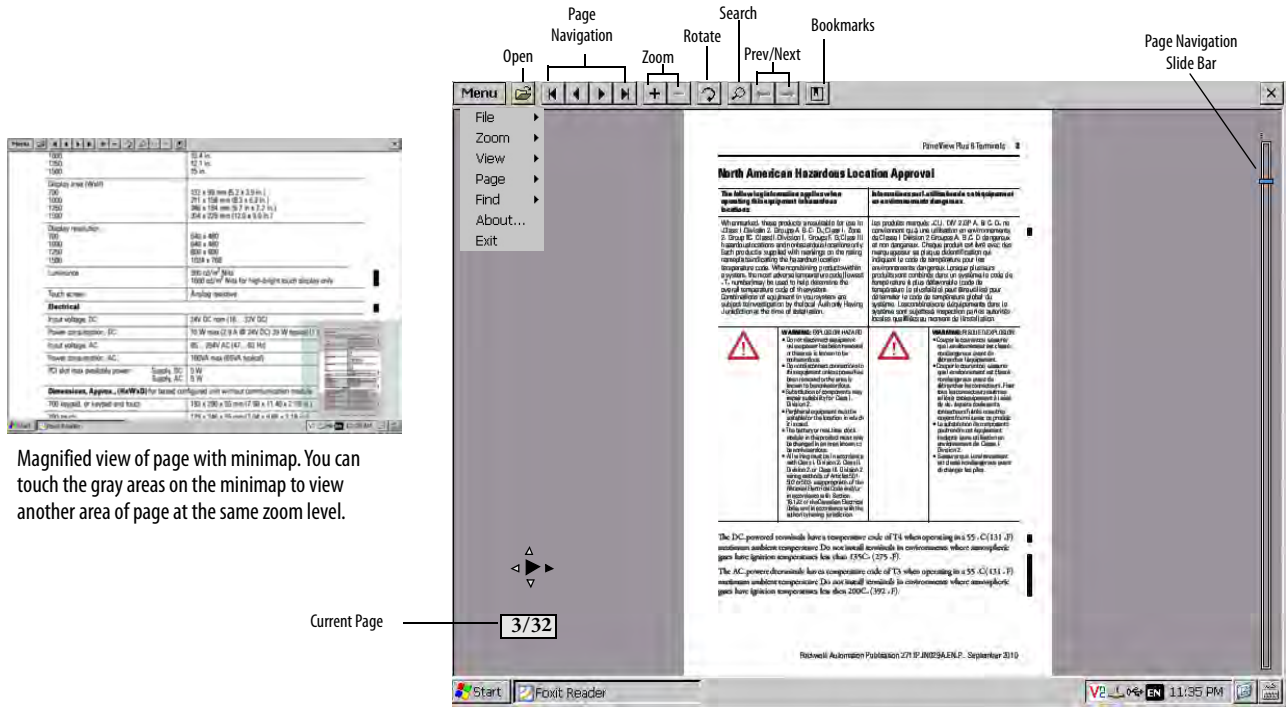

Magnified view of page with minimap. You can touch the gray areas on the minimap to view another area of page at the same zoom level.

**TIP** If a keyboard is attached, you can use the Page Up and Page Down keys for page navigation. On keypad terminals, hold down the Alt key while pressing the up and down cursor keys.

Some viewing functions can be initiated on touch-screen terminals by touching or dragging.

**Table 58 - Touch Screen operations**

To	Do This	Indicator
Zoom In or Out	Tap the screen once to zoom in. Tap the screen again to zoom out. If Menu>View>Minimap is chosen, a miniview of the page appears in lower right of workspace. You can tap the gray areas to change view.	
Navigate pages	<ul style="list-style-type: none"> <li>Drag your stylus or finger to the right or left to view next and previous pages. An indicator shows the direction your are dragging. A box shows the current page/total page count.</li> <li>Drag up or down the screen to activate the page navigation bar on the right. Move slide bar up or down to navigate pages.</li> </ul>	  See page navigation bar in <a href="#">Figure 13</a> .
Rotate	Drag in a circular, clockwise or counterclockwise direction to rotate the page.	

## Command Prompt Parameters

You can run the PDF reader from the Windows Command Prompt by choosing Start>Programs>Command Prompt and executing the command parameters in [Table 59](#).

### Command Prompt Syntax

Foxitreader "file\_path/file-name.pdf" *parameter parameter\_value*

- Enclose the file path and file name in double quotes and use forward slashes to separate the file path directories and file name.
- Use spaces to separate the parameter from the file name and optional parameter value.

### Command Prompt Example

Foxitreader "windows/desktop/example.pdf" -p 4

This command prompt opens example.pdf in Foxit Reader at page 4.

**Table 59 - Command Prompt Parameters**

Parameter	Parameter Function	Example	Description
-p	Go to page	Foxitreader "file_path/file.pdf" -p 2	Opens the PDF file to page 2.
-zw	Fit width	Foxitreader "file_path/file.pdf" -zw	Opens the PDF file and fits the view to the page width.
-zp	Fit page	Foxitreader "file.pdf" -zp	Opens the PDF file and shows the full page.
-z	Zoom to	Foxitreader "file.pdf" -z 150	Opens the PDF file and zooms to 150%.
Multiple parameters	Enter empty spaces between parameters and parameter values	Foxitreader "file_path/file.pdf" -p 2 -zw	Opens the PDF file to page 2 and fits the view the page width
-b	Go to bookmark	Foxitreader "file_path/file.pdf" -b "Bookmark1"	Opens the PDF file to the location specified within Bookmark1
-d	Go to named destination	Foxitreader "file_path/file.pdf" -b "Destination1"	Opens the PDF file to the location specified within Destination 1.
-g	Disable the File>Open command on the Menu and the Open folder button.	Foxitreader "file_path/file.pdf" -g	Opens the PDF file and dims the Menu, File>Open command the Open button.

## Image Viewer

Use the Image Viewer to view bmp, jpg, and png images. You can control how images are viewed to create a slide show. Images can be sorted, rotated, zoomed. You can set the timing between slides and use other transition effects.

To run the image viewer, choose Start>Programs>File Viewers>Image Viewer>imageviewer.

For help on using the viewer, see the help available from the Image Viewer menu.

**Notes:**

## Install and Replace Components

Topic	Page
Install or Replace the Logic Module	118
Install or Replace a Communication Module	119
Replace the Display Module	121
Replace the Bezel	122
Replace the Backlight	124
Replace the Battery	128
Install the AC Power Supply Module	130
Remove the Product ID Label	132
Replace the Keypad Legend Inserts	132
Load an SD Card	134
Clean the Display	134



### ATTENTION: Prevent Electrostatic Discharge

This equipment is sensitive to electrostatic discharge, which can cause internal damage and affect normal operation.

Follow these guidelines when you handle this equipment:

- Touch a grounded object to discharge potential static.
- Wear an approved grounding wriststrap.
- Do not touch connectors or pins on component boards.
- Do not touch circuit components inside the equipment.
- Use a static-safe workstation, if available.
- Store the equipment in appropriate static-safe packaging when not in use.



### ATTENTION: Shock Hazard

Disconnect power from the terminal before installing or replacing any components. Failure to disconnect power can result in electrical shock or damage to the terminal.

## Required Tools

You need a #1 and #2 Phillips screwdriver to replace some of the components.

## Install or Replace the Logic Module

The display modules and logic modules for the 700, 1000, 1250, and 1500 terminals can be ordered as separate components for field installation. If modules are ordered as separate components, attach the logic module to the display module before panel installation.

1. Make sure power is disconnected from the terminal.
2. Set the display module display-side down on a clean, flat, stable surface.
3. Position the logic module over the back of the display module, aligning the logic module connector with the connectors on the display module.

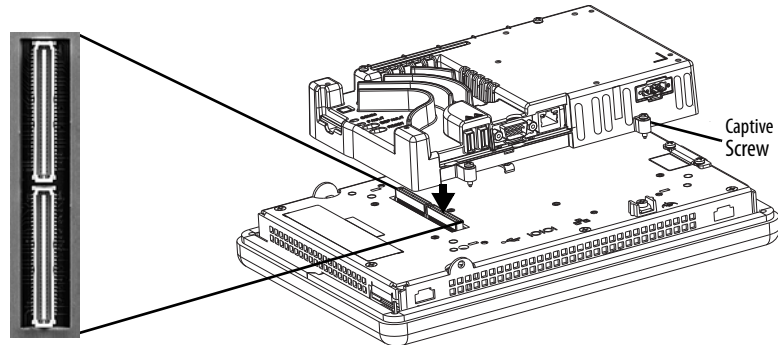

4. Push down on the logic module until it is firmly seated.
5. Tighten the four captive screws that secure the logic module to the display module and torque to 0.58 N•m (5...7 lb•in).

Before replacing a logic module, you must first remove the communication module, if attached.

Follow these steps to replace a logic module.

1. Disconnect power from the terminal.
2. Disconnect all power and communication cables.



**WARNING:** Do not connect or disconnect any communication cable with power applied to this device or any device on a network. An electrical arc could cause an explosion in hazardous location installations. Be sure power is removed or the area is known to be nonhazardous before proceeding.

3. Set the display module display-side down on a clean, flat, stable surface.

- Remove the four screws that secure the communication module, if attached, to the logic module and set the communication module aside.

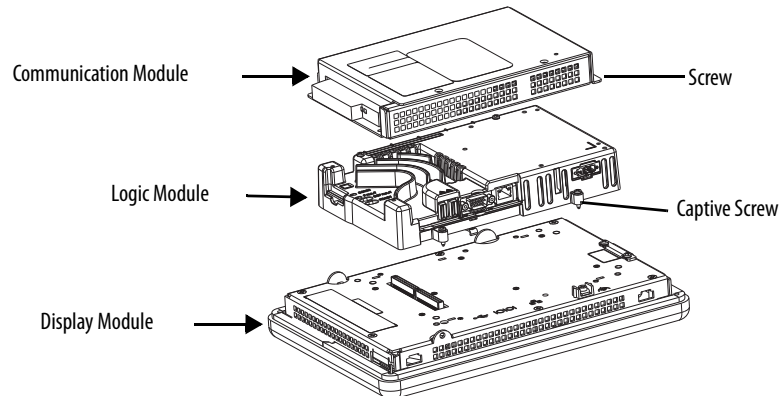

- Loosen the four captive screws that secure the logic module to the display module.
- Carefully lift the logic module from the back of the display.



**ATTENTION:** Wear a properly grounded ESD wristband before touching any of the electronic components in the logic module.

- Install the new logic module and torque the four captive screws to 0.58 N•m (5...7 lb•in).
- Install, the communication module, if necessary, and torque the four screws to 0.58 N•m (5...7 lb•in).

## Install or Replace a Communication Module

The communication module installs over the logic module. Communication modules for the 700, 1000, 1250, and 1500 terminals are available as separate catalog numbers for field installation.

**TIP** The logic module must be attached to the display module before you attach the communication module.

Follow these steps to install a communication module.

- Disconnect power from the terminal.

2. If the display module is removed from the panel, set the terminal, display-side down, on a clean, flat, stable surface.

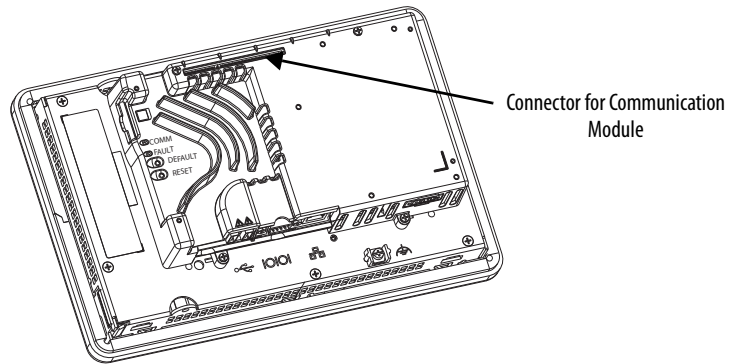

3. Position the communication module over the logic module so that the connector on the bottom of the module aligns with the connector on the logic module.
4. To prevent ESD between the modules, let the communication module touch the logic module before making the connection.

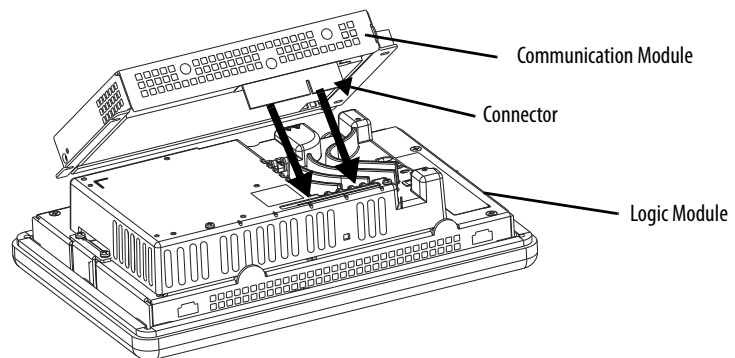

5. Push down on the communication module until the connectors are seated.
6. Tighten the four screws that secure the communication module to the logic module to a torque of  $0.58 \text{ N}\cdot\text{m}$  ( $5\text{...}7 \text{ lb}\cdot\text{in}$ ).

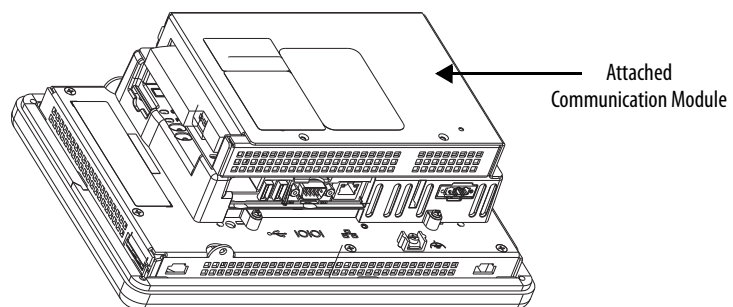



Follow these steps to replace a communication module.

1. Disconnect power from the terminal.
2. Disconnect communication cables from the module.



**WARNING:** Do not connect or disconnect any communication cable with power applied to this device or any device on a network. An electrical arc could cause an explosion in hazardous location installations. Be sure power is removed or the area is known to be nonhazardous before proceeding.

3. Remove the four screws that secure the communication module.
4. Carefully lift the communication module away from the logic module.
5. Install the new communication module by following steps 4..6 in [Install or Replace a Communication Module on page 119](#).

## Replace the Display Module

Follow these steps to replace a 700, 1000, 1250, or 1500 display module.

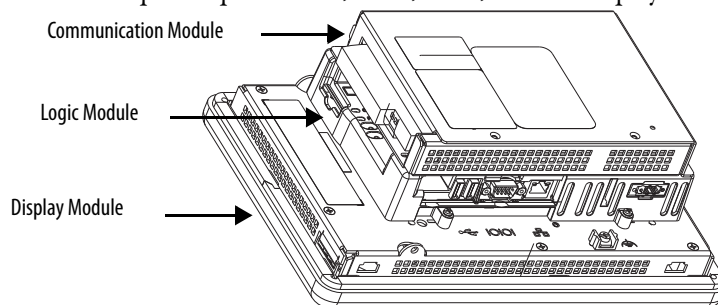

Follow these steps to replace the display module.

1. Disconnect power from the terminal.
2. Remove the terminal from the panel.
3. Detach the communication module, if attached, from the logic module by removing the four screws.
4. Loosen the four captive screws that attach the logic module to the display module.
5. Carefully lift the logic module from the display module.
6. Set the display module aside.

7. Position the logic module over the new display module so that the connectors align.

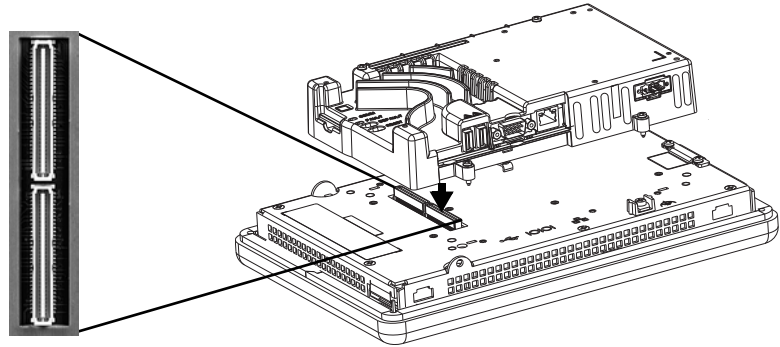

8. Push down on the logic module until firmly seated.
9. Tighten the four captive secures that secure the logic module to the display module and torque to 0.58 N•m (5...7 lb•in).
10. Attach the communication module, if necessary, and torque the four screws to 0.58 N•m (5...7 lb•in).

## Replace the Bezel

You can replace the bezel on the 700, 1000, 1250, and 1500 terminals. It is not necessary to remove the logic module or communication module before removing the bezel, except on the 700 terminal.

## Remove the Display Module Bezel

Follow these steps to remove the display module bezel.

1. Disconnect power from the terminal.
2. Set the terminal, display side down, on a flat stable surface.



**ATTENTION:** Wear a properly grounded ESD wristband before touching any of the electronic components in the logic module.

3. On touch-screen only terminals, remove the two screws that secure the small metal plate to the back of the display module.

4. Disconnect the touch screen connector.

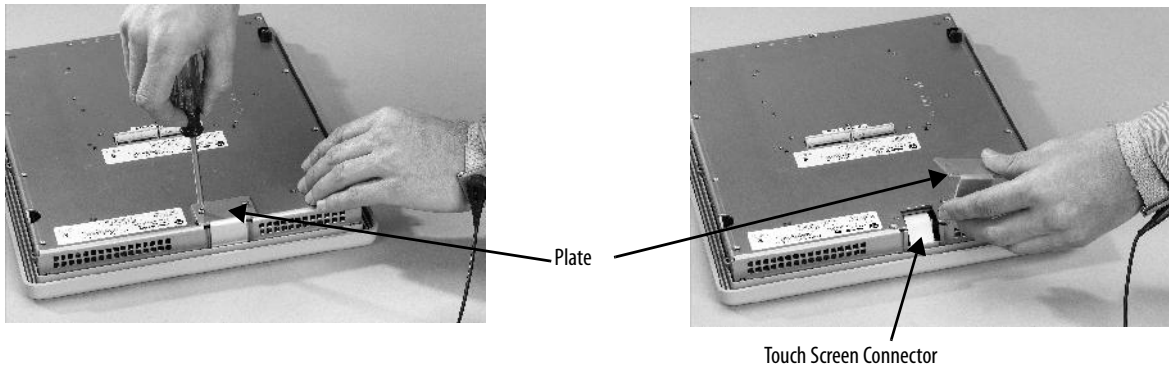

5. Remove the screws from the back of the display module.  
The number of screws varies for each terminal type.

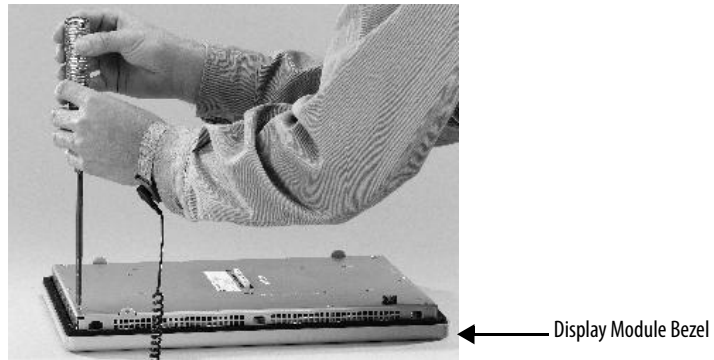

6. Remove the sealing gasket.



7. Lift the back of the display module away from the bezel.  
Work on a clean, flat, stable surface to protect the display from debris, scratches and damage.
8. Detach the connectors.
- Function key connector
  - Connector on keypad or keypad/touch units
9. Set the bezel aside.

## Replace the Display Module Bezel

Follow these steps to replace the display module bezel.

1. Make sure the bezel is free of lint and marks before attaching.
2. Attach the connectors.
  - Function key connector
  - Connector on keypad or keypad/touch units
3. Place the back of the display module over the bezel.
 

Be careful not to pinch any of the cables. Let the touch screen connector out of the access opening.
4. Attach the touch screen connector.
5. Replace the new sealing gasket.
6. Attach the screws that secure the display module to the bezel and tighten to a torque of 1.35...1.58 N•m (12...14 lb•in).
7. On touch-screen terminals, reattach the small metal plate to the back of the display module and torque the two screws to 0.58 N•m (5...7 lb•in).

## Replace the Backlight

The 700, 1000, 1250, and 1500 CCFL-display modules have replaceable backlights except for the 1250 high-bright displays. Backlight replacement does not apply to LED displays.

**Table 60 - CCFL Backlight Replacements<sup>(1)</sup>**

Use Cat. No.	For Display	Series	Number of CCFL Backlights
2711P-RL7C	700	A and B	1
2711P-RL7C2		C and D	1
2711P-RL10C	1000	A	1
2711P-RL10C2		B and C	1
2711P-RL12C	1250	A and B	2
2711P-RL12C2		C	1
2711P-RL15C	1500	B	2

(1) These CCFL-backlight replacement catalog numbers do not apply to LED displays.

---

**IMPORTANT** Disposal: The backlights for these products contain mercury. Dispose of per applicable laws.

---

Follow these steps to replace the backlight.

1. Disconnect power from the terminal.
2. Remove the display module bezel.

---

**IMPORTANT** The 700 series C display is not secured by screws and is retained only by a bracket. Use care not to drop the display once the bezel is removed.

---

3. Remove the four screws that secure the LCD display.

For 700 displays, remove the four screws that secure the display bracket.

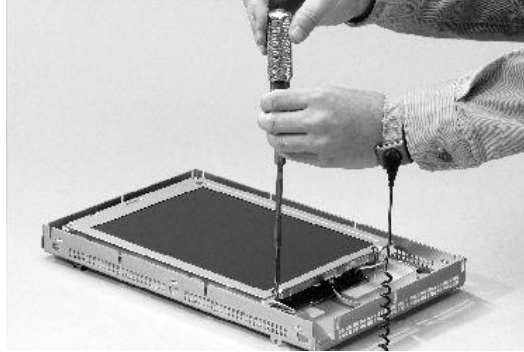

4. Lift the LCD display and detach the display connector from the circuit board.

The circuit board layout can vary for each terminal model. The location of the connector varies by model.

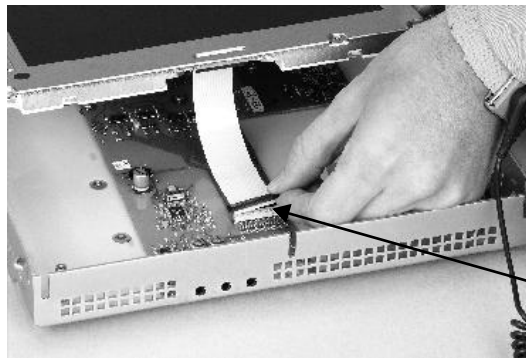

5. Detach the backlight connectors from the circuit board.
  - The 1250 has one or two backlight connectors depending on the series of the display.
  - The 1500 has four backlight connectors.

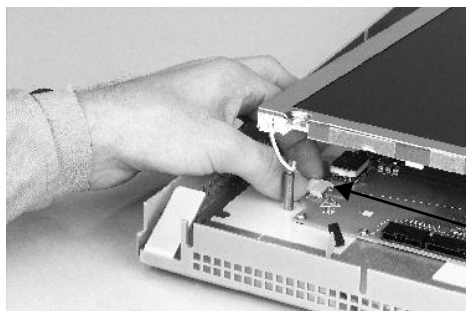

1250

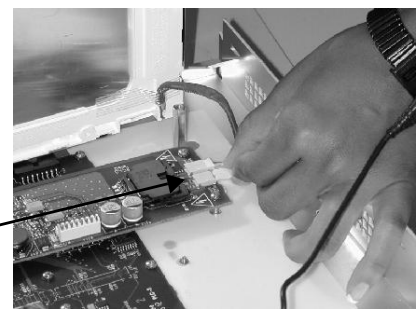

1500

6. Follow these steps for the 700 and 1000 displays.
  - a. Press the retaining tab that secures the backlight, then pull out the backlight.

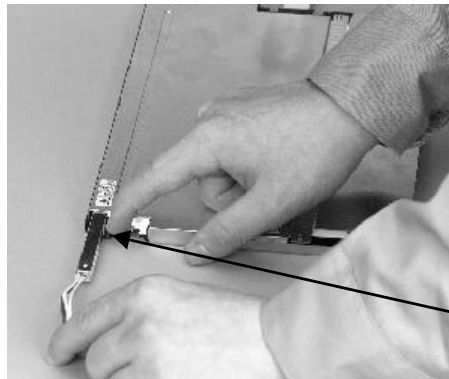

Backlight  
Retaining Tab

- b. Insert the new backlight.

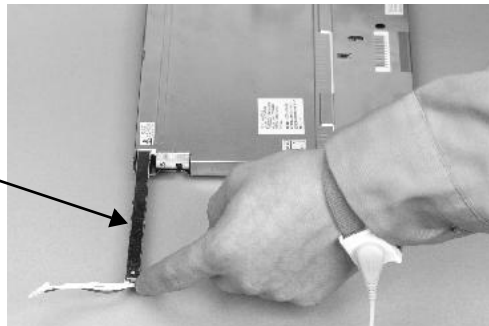

Backlight

7. Follow these steps for the 1250 and 1500 displays.
  - a. Remove the screws that secure the backlights and remove the backlights.

For the 1250 series A and B displays, the two backlights are each secured with two screws. The single backlight for the 1250 series C displays is secured with one screw.

For the 1500 series B displays, remove the tape, then remove the backlights.

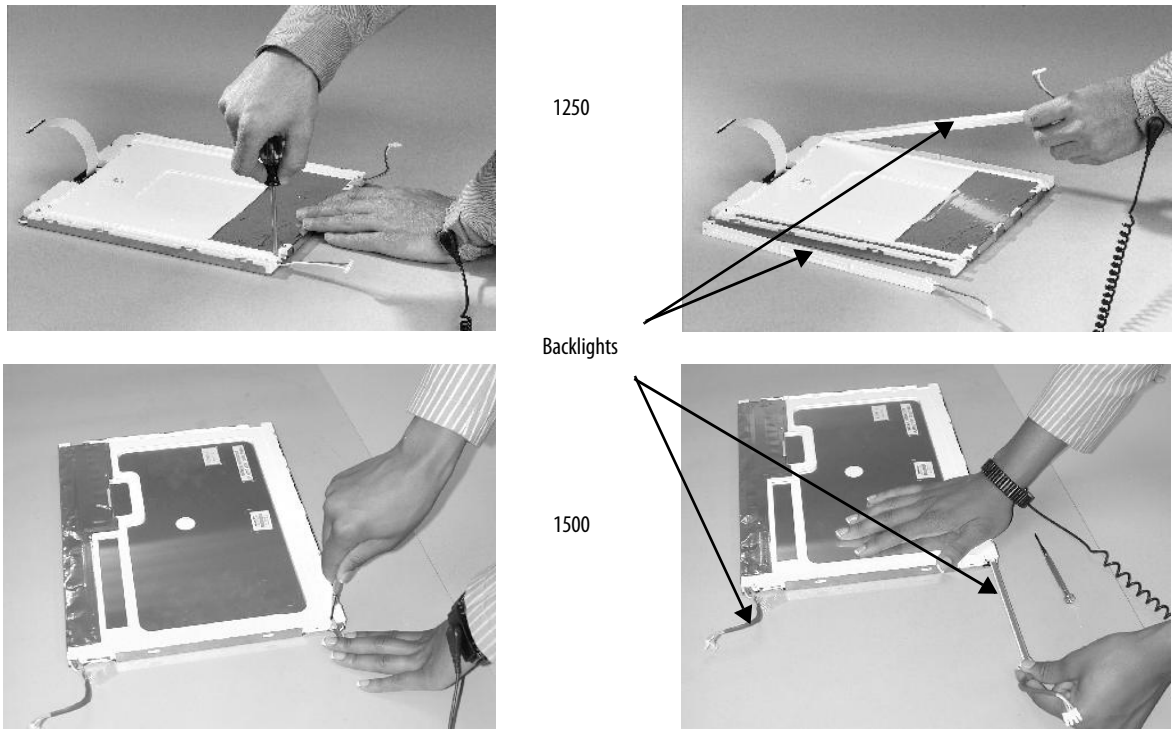

- b. Insert the new backlights then secure each with the same screws from the previous step, and torque to 0.117 N•m (1.04 lb•in).
8. Attach the LCD display connector to the circuit board.  
Refer to [step 4](#).
9. Attach the backlight connector to the circuit board.  
Refer to [step 5](#).
10. Secure the LCD display.
  - a. Attach the display bracket then secure the display in the bracket for the 700 series C display.
  - b. Attach the four screws for all other displays.  
Tighten the screws and torque to 0.58 N•m (5...7 lb•in).
11. Replace the display module bezel.

## Replace the Battery

The product has a lithium battery that is used by the real-time clock. The battery is not used for backup or retention.



This product contains a sealed lithium battery which may need to be replaced during the life of the product.

At the end of its life, the battery contained in this product should be collected separately from any unsorted municipal waste.

The collection and recycling of batteries helps protect the environment and contributes to the conservation of natural resources as valuable materials are recovered.

---



**ATTENTION:** Shock Hazard

Failure to follow proper safety precautions could result in severe electrical shock or damage to the terminal.

---



**WARNING:** There is a danger of explosion if the lithium battery or real-time clock module in this product is incorrectly replaced. Do not replace the battery or real-time clock module unless power has been removed and the area is known to be nonhazardous.

Replace the battery with catalog number 2711P-RY2032 or an equivalent CR2032 coin cell battery.

Do not dispose of the lithium battery or real-time clock module in a fire or incinerator. Dispose of used batteries in accordance with local regulations.

For safety information on the handling of lithium batteries, including handling and disposal of leaking batteries, see Guidelines for Handling Lithium Batteries, publication [AG 5-4](#).

---

## 400 and 600 Terminals

You can replace the battery with the terminal mounted in the panel. No special tools are required to remove the battery.

Follow these steps to replace the battery in a 400 or 600 terminal.

1. Disconnect power from the terminal.
2. Unlatch the battery cover by pulling it straight out.



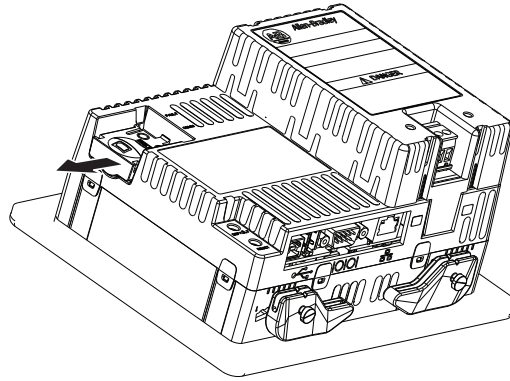

3. Lift up on the cover.
4. Remove the battery.

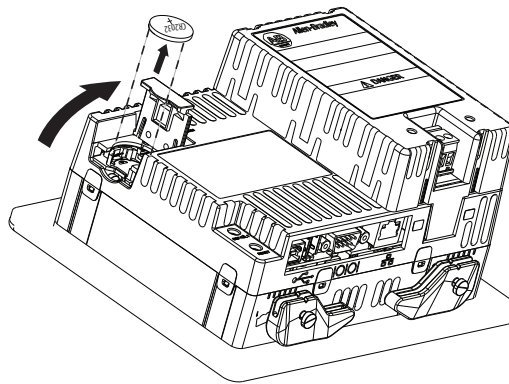

5. Insert the new battery with the positive (+) polarity facing up and press gently until the battery snaps into place.

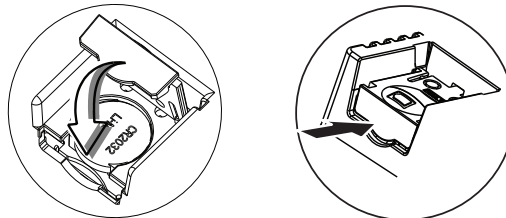

6. Close the battery cover and push the end in until you hear a click.

## 700 to 1500 Terminals

Follow these steps to replace the battery.

1. Disconnect power from the terminal.
2. Place the terminal, display side down, on a flat stable surface.
3. Detach the communication module, if attached, from the logic module by removing the four screws.
4. Loosen the four captive screws that attach the logic module to the display.

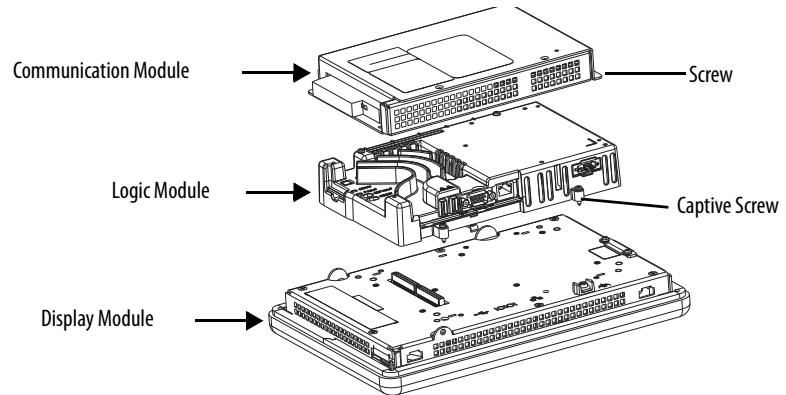

5. Carefully lift the logic module away from the terminal and turn over to expose the circuit board.
6. Locate the battery on the circuit board.
7. Remove the battery by lifting up the side of the battery.  
The battery can be removed up to 15 seconds without losing clock and calendar data.
8. Insert the new battery.
9. Reattach the logic module by aligning the two connectors on the bottom of the logic module with the connectors on the back of the display module.

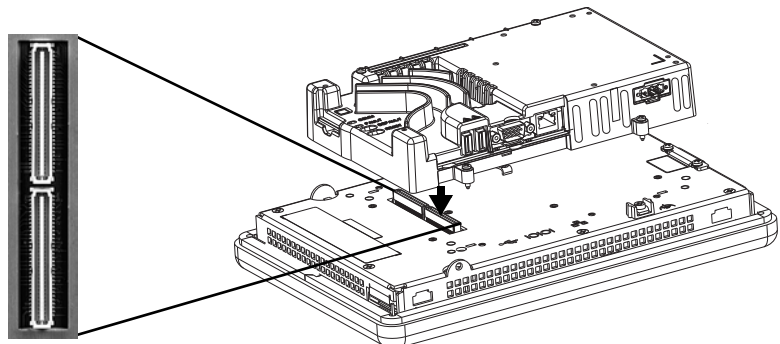

10. Push down on the logic module until it is firmly seated.
11. Tighten the four captive screws that secure the logic module to a torque of 0.58 N•m (5...7 lb•in).
12. Reattach the communication module, if necessary, and tighten the four screws to a torque of 0.58 N•m (5...7 lb•in).

## Install the AC Power Supply Module

The AC power supply module for the 400 and 600 terminals, catalog number 2711P-6RSA, attaches to the back of a DC-powered terminal to convert the terminal from DC to AC power. You can install the AC module with the terminal mounted in the panel. No special tools are needed.

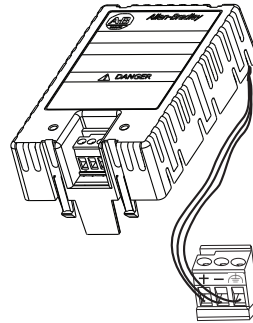

Follow these steps to attach and wire the AC power module.

1. Disconnect power to the terminal.
2. Remove the DC power terminal block currently installed in your terminal.  
See [Remove and Install the Power Terminal Block on page 35](#).
3. Plug the DC power terminal block connected to the AC power supply module into the terminal.

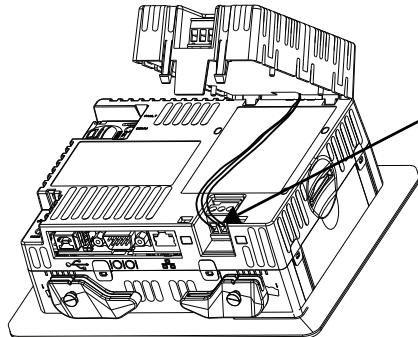

4. Insert the two short tabs on the AC module into the slots on the back of the terminal.

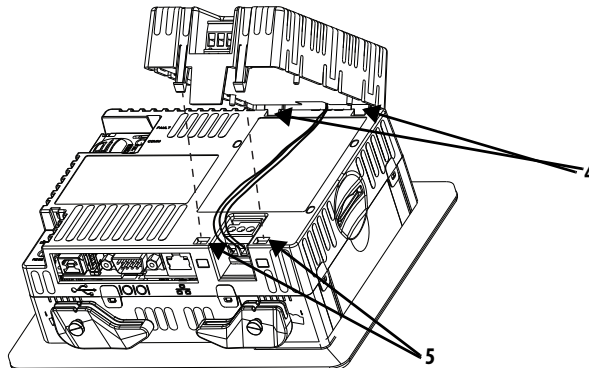

5. Push down on the module until the two long tabs snap into the slots on the opposite side of the terminal.

Make sure the module is securely connected and that the power supply wires are not pinched between the module and the terminal.

6. Connect AC power to the terminal block on the AC module.

Refer to [Connect AC Power on page 40](#) for details on how to wire power.

Follow these steps to remove the AC power module.

1. Disconnect power to the terminal.
2. Remove the AC power wiring from the power terminal block.
3. Insert a small, flat-blade screwdriver into one of the two slots below the AC module and pry up carefully to release the tabs from the slot.
4. Pull up on the front of the module to release the back tabs.
5. Remove the DC power terminal block and wiring from the terminal.

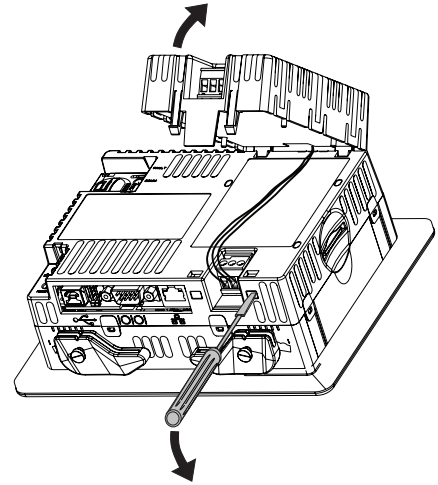

**Remove the Product ID Label** You can replace the product ID label on the terminal with a custom label.

1. Remove the Allen-Bradley label by using your fingers or a tweezers.



2. Clean area with damp cloth and isopropyl alcohol.
3. Remove adhesive backing of new label and affix to the same location.

## Replace the Keypad Legend Inserts

Legend strips are available as separate catalog numbers for keypad terminals, except for the 400 keypad terminals. One side of the legend strips have default key legends; the other side is blank for creating custom legends.

### 600 Terminals

The legend inserts for function keys F1...F10 are accessible from the back of the unit and can be replaced with the terminal mounted in the panel.

Follow these steps to replace the legend insert.

1. Disconnect power to the terminal.

- From the rear of the unit, pull the legend strip from the slot.



- Slide the new legend insert into the same slot.

### 700 to 1500 Terminals

On the 700 to 1500 terminals, the F1-Fxx legend strips are accessible from the back of the unit.

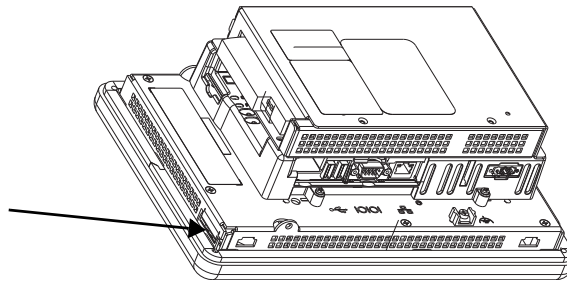

The K1-Kxx legend inserts are accessible when the display bezel is removed.

Follow these steps to replace the K1-Kxx key legend inserts.

- Remove power from the terminal.
- Remove the display module bezel as described on [page 122](#).
- Pull the legend inserts out from the slots on the bezel.

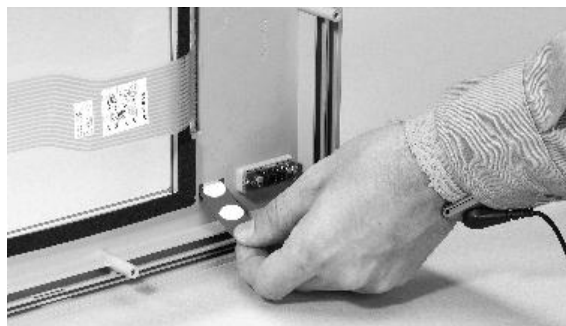

- Slide the new legend strips into the slots until only the end tab is visible.
- Replace the display module bezel.

## Load an SD Card

A Secure Digital (SD) card provides extra storage when inserted into the SD card slot. Supported cards include catalog number 1784-SDx. The SD cards are hot-swappable; they can be inserted and removed while the terminal is operating.

The SD card slot is accessible from the inside or back of the panel in which the terminal is installed.

Follow these steps to install an SD card in the card slot.

1. Verify that the SD card is locked or unlocked according to your preference:
  - If unlocked, the terminal can write data to or read data from the card.
  - If locked, the terminal can only read data from the card.

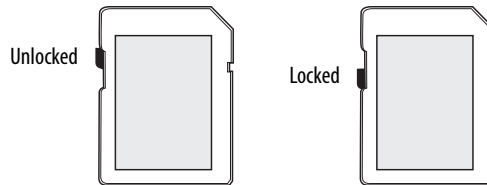

**ATTENTION:** Orient the SD card correctly before inserting into slot. Forcing the card into the slot can damage the card or the terminal.

2. Insert the SD card firmly into the slot until you hear a click.

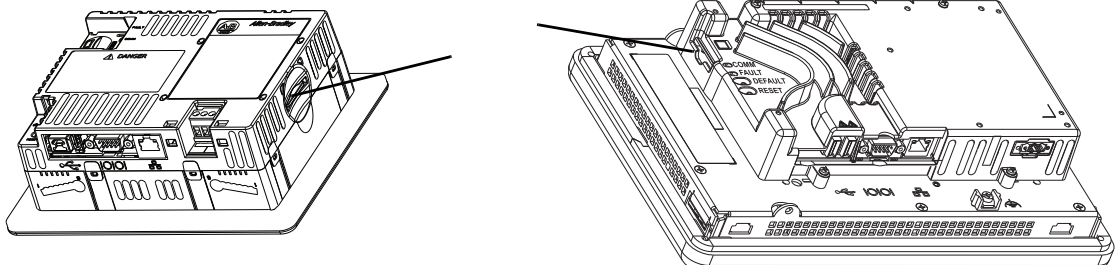

Press and release the SD card to eject the card from the slot.

**TIP**

- SD card volumes are named StorageCard2, StorageCard3,...
- SD card volumes and their physical characteristics are consistent with the CompactFlash card used by other PanelView™ Plus products. You can migrate applications on CompactFlash cards to an SD card.

## Clean the Display

Use a protection antiglare overlay for easier cleaning of the display screen.



**ATTENTION:** Abrasive cleaners or solvents can damage the display. Do not scrub or use brushes on the display.

Follow these steps to clean the display screen.

1. Disconnect power from the terminal.
2. Use a clean sponge or soft cloth with mild soap or detergent to clean the display.

3. Dry the display with a chamois or moist cellulose sponge to avoid water spots.

Remove fresh paint splashes and grease before drying by rubbing lightly with isopropyl alcohol (70% concentration). Then wash the display by using mild soap or detergent. Rinse with clean water.

**Notes:**



---

## Terminal Connections

Topic	Page
USB Ports	138
Ethernet Connections	140
Serial Connections	142
DH-485/DH+ Communication Module	145
ControlNet Communication Module	148
Controller Connections	151



### **ATTENTION: Wiring and Safety Guidelines**

Use publication NFPA 70E, Electrical Safety Requirements for Employee Workplaces, IEC 60364 Electrical Installations in Buildings, or other applicable wiring safety requirements for the country of installation when wiring the devices. In addition to the NFPA guidelines, here are some other guidelines to follow:

- Route communication cables to terminal by a separate path from incoming power. Do not run signal wiring and power wiring in the same conduit.
- Cross power and communication lines at right angles if they must cross.
- Communication lines can be installed in the same conduit as low-level DC I/O lines (less than 10V).
- Shield and ground cables appropriately to avoid electromagnetic interference (EMI). Grounding minimizes noise from EMI and is a safety measure in electrical installations.

For more information on grounding recommendations, refer to the National Electrical Code published by the National Fire Protection Association.

---

## USB Ports

All terminals have one or two USB 2.0 host ports, and the 400 and 600 terminals have one USB 2.0 device port.

**Figure 14 - USB Ports**

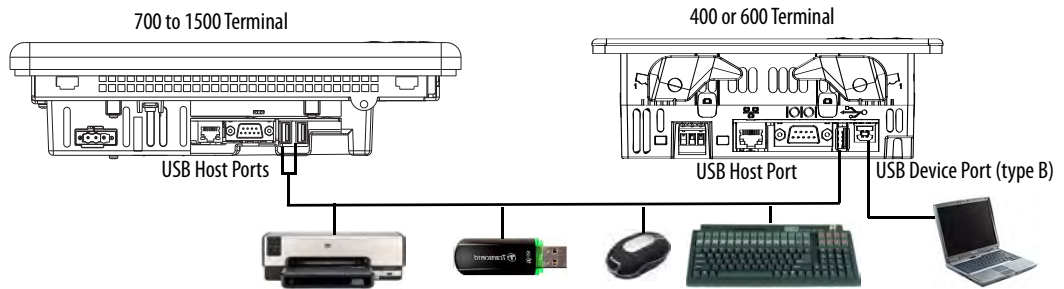

**IMPORTANT** The USB host and device ports are intended only for temporary use and must not be used for runtime operations.



**Table 61 - USB Device Support**

USB Port Type	Supported USB Devices	Tips
Host Ports (type A)	<ul style="list-style-type: none"> <li>• Keyboard or mouse, HID devices with native device drivers</li> <li>• USB flash drives for external storage</li> <li>• Supported printers</li> <li>• Cameras, modems, and bar code readers</li> </ul>	<p>For a list of compatible devices, go to: <a href="http://www.rockwellautomation.com/knowledgebase">http://www.rockwellautomation.com/knowledgebase</a> and search the Knowledgebase for ID 115072.</p> <p>USB flash drive volumes are named USB Storage, USB Storage2,... USB flash drive partitions are managed by Storage Manager in the Control Panel.</p>
Device Port (type B, only 400 and 600 terminals)	Host computer with the USB remote RNDIS network device driver installed.	<p>For details on how to install the USB remote NDIS driver on a computer and configure the terminal for the USB connection, go to <a href="http://www.rockwellautomation.com/knowledgebase">http://www.rockwellautomation.com/knowledgebase</a> and search the Knowledgebase for ID 115608.</p>

**IMPORTANT** Refer to [page 27](#) for information on using the USB host ports and USB peripheral devices in hazardous locations.

The USB ports are identified by a USB icon. Each USB host port supports 0.5 A at 5V DC. Connected USB devices must not exceed this power load.

**Table 62 - USB Connector Pinouts**

USB Icon	USB Ports	Pin	Signal	Description
		1	VCC	+5V
		2	D-	Data -
		3	D+	Data +
		4	GND	Ground

High-speed USB 2.0 certified cables are recommended for error-free transmissions.



**WARNING:** USB devices not powered by the USB port must be within same enclosure as the terminal. USB devices must be connected to a ground system common with the terminal or used with a USB hub providing galvanic isolation.

Connect only externally-powered USB hubs to the terminal. Before attaching devices to a USB hub, make sure the power adapter is connected and powered on.

## Ethernet Connections

The Ethernet port connects to a controller on an EtherNet/IP network by using standard Ethernet and network connections. The port also supports application transfers, and printing.

**TIP** The 2711P-RN20 Ethernet communication module is available for the 700 to 1500 terminals if another Ethernet port is required. The module has its own unique IP address.

### Ethernet Connector

The Ethernet port has an RJ45, 10/100 Base-T connector for network communication and supports MDI/MDI-X connections.

Figure 15 - Ethernet Connector

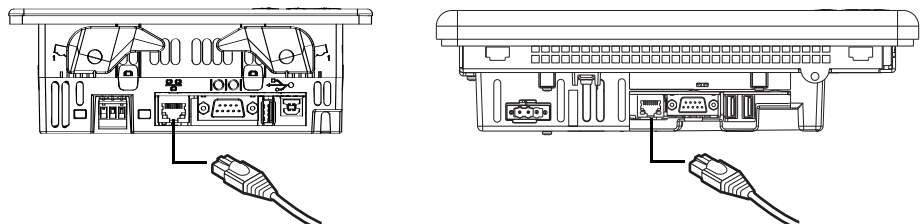

Table 63 - Ethernet Connector Pinout

Connector	Pin	Pin Name	Pin	Pin Name
RJ45 Connector 	1	Transmit +	5	Unused
	2	Transmit -	6	Receive -
	3	Receive +	7	Unused
	4	Unused	8	Unused

Table 64 - Ethernet Status Indicators

Indicator	Status Indicator Color	Description
Link Integrity	Yellow	Asserted when a link is present.
Activity Status Indicator	Green	Pulsed active when receive or transmit activity is present.

### Ethernet Cable

Table 65 - Ethernet Cable Requirements

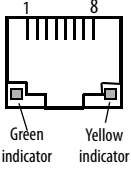
For These Terminal Models	Use this Ethernet Cable
700 to 1500 terminals	Belden 7921A shielded CAT5E cable according to TIA 568-B.1 and RJ45 connector according to IEC 60603-7 for compliance with Marine emission limits and the European Union 89/336/EEC EMC Directive.
400 to 600 terminals	Use category five, twisted-pair cables. You can use a standard Ethernet cable or a crossover cable, such as catalog number 2711P-CBL-EX04, when connecting directly to a logic controller or switch.

The maximum cable length between the Ethernet port and a 10/100 Base-T port on an Ethernet hub (without repeaters or fiber) is 100 m (328 ft).



**WARNING:** Do not connect or disconnect any communication cable with power applied to this device or any device on the network. An electrical arc could cause an explosion in hazardous location installations. Be sure that power is removed or the area is nonhazardous before proceeding.

## Security Considerations

IGMP (Internet Group Management Protocol) is used for IPv4 multicast. A multicast is communication between a single sender and multiple receivers on a network. IGMP is used to exchange membership status data between IPv4 routers that support multicasting and members of multicast groups. A router is an intermediary device on a communication network that expedites message delivery by finding the most efficient route for a message packet within a network, or by routing packets from one sub-network to another. A sub-network is a separate part of an organization's network identified through IP addressing.

PanelView™ Plus terminals provide level 2 (full) support for IPv4 multicasting (IGMP version 2) as described in RFC 1112 and RFC 2236.

SNMP (Simple Network Management Protocol) is used for internal network management and is not supported.

Ports 137 and 138 are normally open to support the NetBIOS protocol used by Windows CE.NET similar to other Microsoft and IBM network operating systems.

## Serial Connections

The RS-232 serial port is multi-purpose and supports these connections:

- DH-485 communication through a serial connection
- DF1 full-duplex communication with controllers by using direct connections or modem connections
- Third-party point-to-point communication
- Application transfers and printing

The serial port is a 9-pin, male, RS-232 connector. [Table 66](#) shows the pinout descriptions and how these pins map to the serial ports on the controllers.

The maximum cable length for serial communication is 15.24 m (50 ft).

**Figure 16 - RS-232 Serial Port**

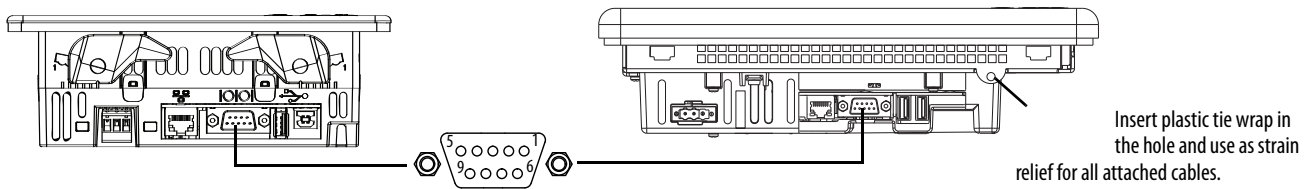

**Table 66 - RS-232 Serial Port Connector Pinout**

PanelView Plus 6 RS-232 Port 9-pin DCE		SLC or Logix 9-pin	PLC 25-pin	MicroLogix/ ENI 8-pin DIN
1				
2	RXD →	2	3	4
3	← TXD	3	2	7
4	← DTR	4	20	
5	← COM →	5	7	2
6	→ DSR	6	6	
7	← RTS	7	4	
8	→ CTS	8	5	
9				
Connector Shell	Chassis Gnd			



**WARNING:** Do not connect or disconnect the communication cable with power applied to the terminal, or the serial device on the other end of the cable. An electrical arc could cause an explosion in hazardous location installations. Be sure that power is removed or the area is nonhazardous before proceeding.

## Modem Connection

Wire or radio modem communication is possible between the terminal and controller. Each modem must support full duplex communication. Refer to your modem user manual for details on settings and configuration.

**Figure 17 - Modem Connection**

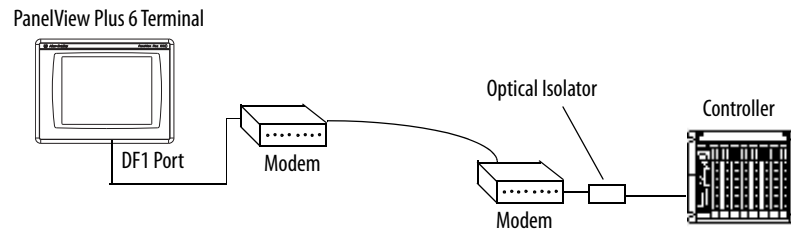

## Construct a Null Modem Cable

To construct a null modem cable, refer to this pinout.

**Table 67 - Null Modem Pinout**

Pin Description	PanelView Plus 6 9-pin	9-pin Modem	PanelView Plus 6 9-pin	25-pin Modem	Pin Symbol
FG (Frame Ground)	-	-	-	1	FG
TD (Transmit Data)	3	2	3	3	RD
RD (Receive Data)	2	3	2	2	TD
RTS (Request to Send)	7	8	7	5	CTS
CTS (Clear to Send)	8	7	8	4	RTS
SG (Signal Ground)	5	5	5	7	SG
DSR (Data Set Ready)	6	4	6	20	DTR
DTR (Data Terminal Ready)	4	6	4	6	DSR

## Computer Connections

The RS-232 serial port supports application uploads and downloads between the terminal and a computer by using a direct connection.

**Figure 18 - Serial Port Connection to Computer**

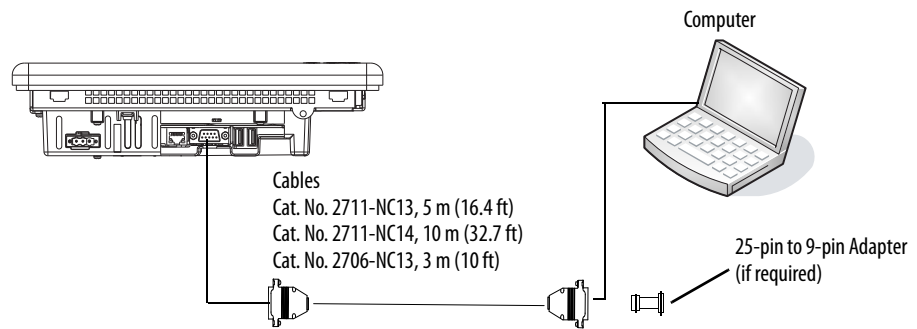

**Table 68 - Upload/Download Cable with Handshaking**

PanelView Plus 6 Port (DCE)		Computer Port (DTE) with Handshaking	
9-pin male		9-pin male	
1 NC		1	DCD
2	RXD →	2	RXD (Data Receive)
3	← TXD	3	TXD (Data Transmit)
4 NC		4	
5	← COM →	5	COM
6 (pulled high to +12V)	DSR →	6	DSR
7	← RTS	7	RTS
8	CTS →	8	CTS
9 NC		9	NC

**Table 69 - Upload/Download Cable without Hardware Handshaking**

PanelView Plus 6 Port (DCE)		Computer Port (DTE)	
9-pin male		9-pin	25-pin
2	RXD →	2	3
3	← TXD	3	2
5	← COM →	5	7



## DH-485/DH+ Communication Module

700 to 1500 terminals with a catalog number 2711P-RN6 or 2711P-RN6K communication module support communication with these networks:

- DH+™ networks
- DH-485 networks

The communication module has a separate port for each communication protocol. You can communicate with one network only at one time.

**Figure 19 - DH-485/DH+ Communication Module Connectors**

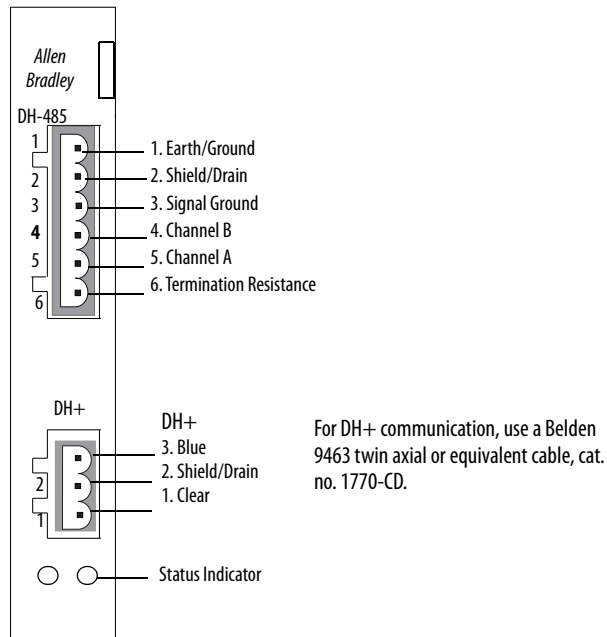

**IMPORTANT** See your controller documentation for appropriate controller connections.

## Status Indicators

The module has indicators that show the status of the DH-485 or DH+ network connection.

**Table 70 - DH-485 and DH+ Status Indicators**

Indicator State	Description
Off	Channel is not online.
Blinking green	Device is only node on the network.
Solid green	Device is online and receiving token.
Blinking red	DH-485: Duplicate node. DH+: Parity error.
Solid red	Failed selftest.

## DH-485 Network Port Wiring

Refer to the figures to attach the RS-485 connector to a Belden 3106A or 9842 cable. Refer to [Controller Connections on page 151](#) if you are using standard Allen-Bradley® cables.

**IMPORTANT** A daisy-chained network is recommended. We do not recommend a hybrid star/daisy-chain network as shown.

**Figure 20 - Daisy-chain Connection**

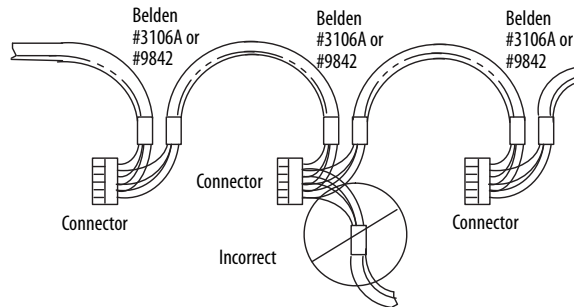

Attach the connector to a Belden 3106A or 9842 cable as shown in [Figure 21](#) or [Figure 22](#).

**Figure 21 - Single Cable Connection**

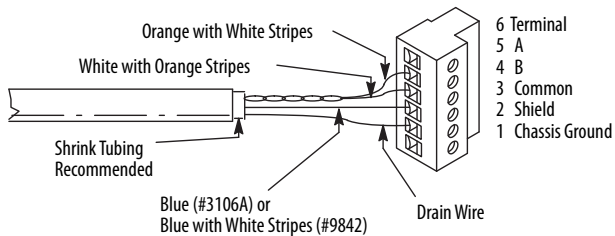

**Figure 22 - Multiple Cable Connection**

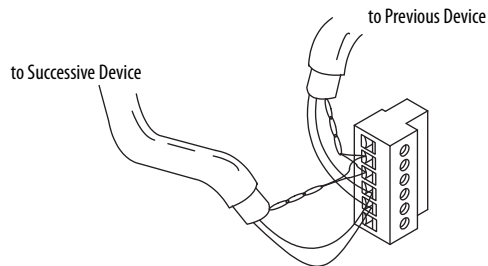

**Table 71 - Belden 3106A Wire Connections**

For this Wire/Pair	Connect this Wire	To this Terminal
Shield/Drain	Non-jacketed	Terminal 2 - Shield
Blue	Blue	Terminal 3 - (Common)
White/Orange	White with Orange Stripe	Terminal 4 - (Data B)
	Orange with White Stripe	Terminal 5 - (Data A)

## DH+ Network Connections

Use a Belden 9463 twin-axial or equivalent cable, catalog number 1770-CD, to connect a terminal to a DH+ link.

You can connect a DH+ link in two ways:

- **Trunk line/drop line** - from the drop line to the connector screw terminals on the DH+ connectors of the processor.
- **Daisy chain** - to the connector screw terminals on the DH+ connectors on the processor.

Follow these guidelines when installing DH+ communication links:

- Do not exceed these cable lengths:
  - Trunk line-cable length: 3048 m (10,000 ft)
  - Drop-cable length: 30.4 m (100 ft)
 The maximum cable length is determined by the baud rate.
- Do not connect more than 64 stations on a single DH+ link.

**Figure 23 - Terminal Connection to DH+ Link**

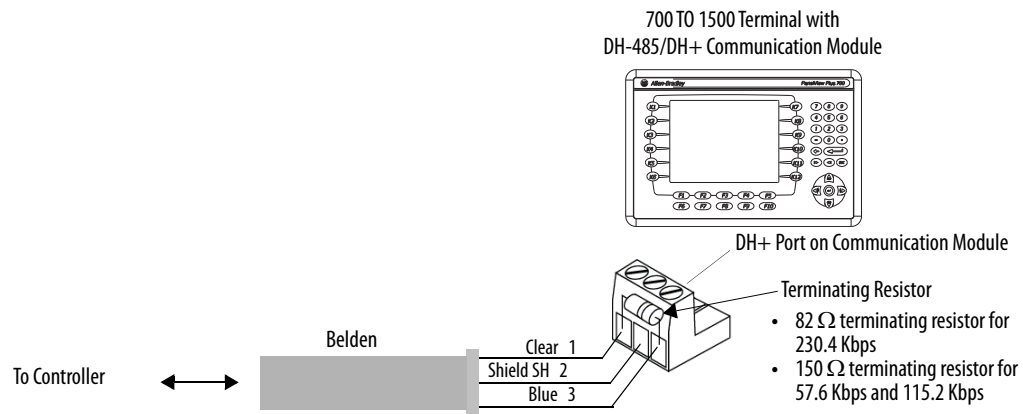

## ControlNet Communication Module

700 to 1500 terminals with a catalog number 2711P-RN15S or 2711P-RN15SK communication module support ControlNet communication and the transfer of applications between devices on a ControlNet network.

### Additional Resources

For more information on ControlNet products, refer to these publications:

- NetLinx Selection Guide, publication [NETS-SG001](#)
- ControlNet Coax Media Planning and Installation Guide, publication [CNET-IN002](#)

The Rockwell Automation website <http://www.rockwellautomation.com> provides information and product descriptions of ControlNet products.

### ControlNet Protocol

The terminals support Unscheduled and Scheduled messaging, Scheduled I/O, and redundant cabling with PLC-5C and ControlLogix controllers.

The ControlNet architecture supports multiple processors and up to 99 nodes (via taps) anywhere along the trunk cable of the network. There is no minimum tap separation and you can access the ControlNet network from every node (including adapters).

### Compatible ControlNet Controllers

A PanelView Plus 6 terminal with a ControlNet module communicates with a PLC-5C or ControlLogix controller by using Unscheduled messaging:

- PLC-5C (PCCC commands)
- ControlLogix controller (CIP protocol)

These controllers are supported:

- ControlLogix controller with a 1756-CNB ControlNet module
- PLC-5/20C, PLC-5/40C, PLC-5/60C, PLC-5/80C

## Software and Firmware Requirements

The software and firmware must be installed on the development computer and the PanelView Plus 6 terminal to configure and communicate with an Allen-Bradley controller on a ControlNet network.

**Table 72 - ControlNet Unscheduled Communication**

Software/Firmware	Minimum Version
FactoryTalk® View Studio	6.0 or later
FactoryTalk View Machine Edition Runtime	6.0 or later
ControlNet module firmware	2711P-RN15S, Series A, Rev A (firmware revision 2.07 or later) <sup>(1)</sup>

(1) This applies to terminals that are ordered as pre-configured units with the ControlNet module.

**Table 73 - ControlNet Scheduled Communication**

Requirements	Minimum Version
FactoryTalk View Studio	6.0 or later
FactoryTalk View Machine Edition Runtime	6.0 or later
RSNetWorx™ for ControlNet	5.11 or later
Studio 5000®	21.00.00 or later
ControlNet module firmware	2711P-RN15S, Series A, Rev C (firmware revision 3.08 or later) <sup>(1)</sup>

(1) This applies to terminals that are ordered as preconfigured units with the ControlNet module.



**WARNING:** The ControlNet communication module, cat. no. 2711P-RN15S or 2711P-RN15SK, does not run with FactoryTalk View ME firmware revision 3.20.04 or earlier. All ControlNet modules with revision 3.07 firmware must be upgraded to revision 3.08 or later; otherwise, outputs can turn on an indeterminate state.

## ControlNet Module Connectors

Figure 24 - Cat. No. 2711P-RN15S or 2711P-RN15SK Communication Module

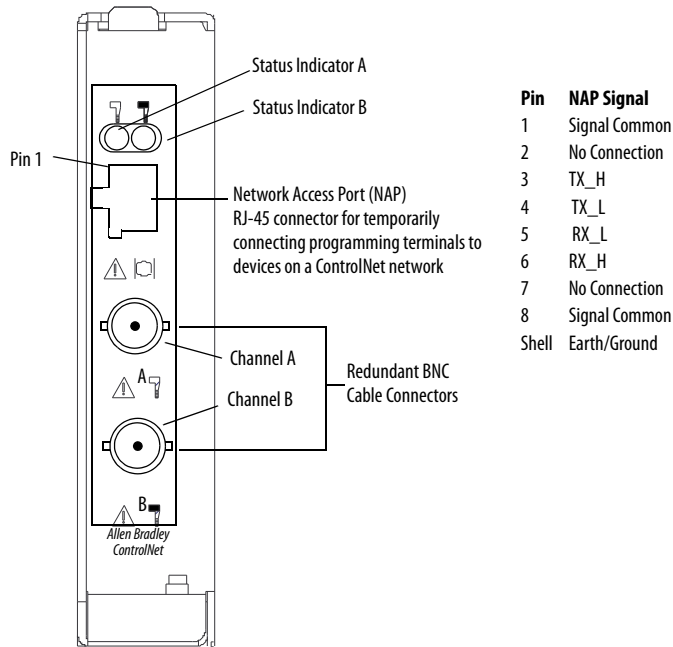

**IMPORTANT** Do not connect to a network by using both the redundant cable BNC connector and the Network Access Port (NAP).

## Module Connection to ControlNet Network

You can make these connections with the ControlNet communication module:

- Connect directly to a ControlNet network which requires a tap.



**ATTENTION:** Do not connect more than one ControlNet network to the communication module. If you attempt to connect a second network to the module, your communication system can operate erratically.

- Connect to a device already connected to the ControlNet network.

Refer to the ControlNet Coax Media Planning and Installation Guide, publication [CNET-IN002](#), for descriptions of ControlNet components.



**WARNING:** When used in a Class I, Division 2, hazardous location, this equipment must be mounted in a suitable enclosure with proper wiring that complies with the governing electrical codes.



**WARNING:** Do not connect or disconnect any communication cable with power applied to this device or any device on the network. An electrical arc could cause an explosion in hazardous location installations. Be sure that power is removed or the area is nonhazardous before proceeding.

## Controller Connections

The tables provide a summary of PanelView Plus 6 connections to controllers and interface modules for runtime communication.

**Table 74 - PanelView Plus 6 Terminals to SLC Controllers**

Protocol	PanelView Plus 6 Comm Port	SLC 500, 5/01, 5/02 CH1 RJ45 (DH-485)	SLC 5/03, 5/04, 5/05 CH0 (9-pin RS-232) (DF1 or DH-485)	SLC 5/03 CH1 (RJ45) (DH-485)	SLC 5/04 CH1 (DH+)	SLC 5/05 CH1 (ENET)
DF1	RS-232 (DF1) port (9-pin) All terminals	—	2711-NC13 (5 m/16 ft) 2711-NC14 (10 m/32 ft)	—	—	—
DH-485	RS-232 (DH-485) port (9-pin) All terminals	Use AIC+ module (1761-NET-AIC) to connect to port 1 or 2	2711-NC13 (5 m/16 ft) 2711-NC14 (10 m/32 ft)	Use AIC+ module (1761-NET-AIC) to connect to port 1 or 2	—	—
	DH-485 port 700 to 1500 terminals only Require 2711P-RN6, 2711P-RN6K	1761-CBL-AS03 (3 m/10 ft) 1761-CBL-AS09 (9 m/30 ft)	Use AIC+ module (1761-NET-AIC) to connect to port 3	1761-CBL-AS03 (3 m/10 ft) 1761-CBL-AS09 (9 m/30 ft)	—	—
EtherNet/IP	EtherNet/IP port All terminals 2711P-RN20 provides additional port - 700 to 1500 terminals only	—	Use 1761-NET-ENI module with Ethernet cable	—	—	1585J-M type cable or 2711P-CBL-EX04 (4 m/14 ft)
ControlNet	ControlNet port 700 to 1500 terminals only Require 2711P-RN15S, 2711P-RN15SK	—	—	—	—	—
DH+	DH+ port 700 to 1500 terminals only Require 2711P-RN6, 2711P-RN6K	—	—	—	Shielded twinxial cable (1770-CD)	—

**Table 75 - PanelView Plus 6 Terminals to PLC-5 and MicroLogix Controllers**

Protocol	PanelView Plus 6 Comm Port	PLC-5, PLC-5C, PLC-5E CH0 (25-pin RS-232) (DF1)	MicroLogix 1400, 1500LRP CH1/CH2 (9-pin RS-232) (DF1 or DH-485)	MicroLogix 1000, 1100, 1200, 1400, 1500LSP CH0 (8-pin Mini DIN) (DF1 or DH-485)	MicroLogix 1100, 1400 Ethernet
DF1	RS-232 (DF1) port (9-pin) All terminals	2711-NC13 (5 m/16 ft) 2711-NC14 (10 m/32 ft) (9-to-25 pin adapter required)	2711-NC13 (5 m/16 ft) 2711-NC14 (10 m/32 ft)	2711-NC21 (5 m/16 ft) 2711-NC22 (15 m/49 ft) <sup>(1)</sup>	—
DH-485	RS-232 (DH-485) port (9-pin) All terminals	—	2711-NC13 (5 m/16 ft) 2711-NC14 (10 m/32 ft)	2711-NC21 (5 m/16 ft) 2711-NC22 (15 m/49 ft)	—
	DH-485 port 700 to 1500 terminals only Require 2711P-RN6, 2711P-RN6K	—	—	Use AIC+ module (1761-NET-AIC) to connect to port 3	—
EtherNet/IP	EtherNet/IP port All terminals 2711P-RN20 provides additional port - 700 to 1500 terminals only	To PLC-5E with 1585J-M type cable or 2711P-CBL-EX04 (4 m/14 ft)	Use 1761-NET-ENI module with Ethernet cable		1585J-M type cable or 2711P-CBL-EX04 (4 m/14 ft) <sup>(1)</sup>
ControlNet	ControlNet port 700 to 1500 terminals only Require 2711P-RN15S, 2711P-RN15SK	To PLC-5C with ControlNet cable	—	—	—
DH+	DH+ port 700 to 1500 terminals only Require 2711P-RN6, 2711P-RN6K	Shielded twinaxial cable (1770-CD)	—	—	—

(1) The AIC+ module is recommended for isolation purposes when the terminal and controller are not on same power supply.

**Table 76 - PanelView Plus 6 Terminals to Logix Controllers**

Protocol	PanelView Plus 6 Comm Port	ControlLogix CHO (9-pin RS-232) (DF1)	CompactLogix™ CHO (9-pin RS-232) (DF1 or DH-485)
DF1	RS-232 (DF1) port (9-pin) All terminals	2711-NC13 (5 m/16 ft) 2711-NC14 (10 m/32 ft) 2706-NC13 (3 m/10 ft)	2711-NC13 (5 m/16 ft) 2711-NC14 (10 m/32 ft) 2706-NC13 (3 m/10 ft)
DH-485	RS-232 (DH-485) port (9-pin) All terminals	—	2711-NC13 (5 m/16 ft) 2711-NC14 (10 m/32 ft) 2706-NC13 (3 m/10 ft)
	DH-485 port 700 to 1500 terminals only Require 2711P-RN6, 2711P-RN6K	—	Use AIC+ module (1761-NET-AIC) Connect to Port 3
EtherNet/IP	EtherNet/IP port All terminals 2711P-RN20 provides additional port - 700 to 1500 terminals only	Use 1756-EN2T or 1756-ENBT module with 1585J-M type cable or 2711P- CBL-EX04 (4 m/14 ft)	To 1769-L35E, 1769-L23E, 1769-L32E, or 1768-ENBT module with 1585J-M type cable or 2711P- CBL-EX04 (4 m/14 ft)
ControlNet	ControlNet port 700 to 1500 terminals only Require 2711P-RN15S, 2711P-RN15SK	Use 1756-CNB module with ControlNet cable	1769-L35CR, 1769-L32C, 1768-CNB, or 1768-CNBR with ControlNet cable
DH+	DH+ port 700 to 1500 terminals only Require 2711P-RN6, 2711P-RN6K	Use 1756-DHRIO module with shielded twinaxial cable (1770-CD)	—

**Table 77 - PanelView Plus 6 Terminals to Interface Modules**

Protocol	PanelView Plus 6 Comm Port	1747-AIC	1761-NET-AIC			1761-NET-ENI
			Port 1 (9-pin)	Port 2 (8-pin Mini DIN)	Port 3 (DH-485)	Port 2 (8-pin Mini DIN)
DF1	RS-232 port (9-pin) All terminals	—	2711-NC13 (5 m/16 ft) 2711-NC14 (10 m/32 ft)	2711-NC21 (5 m/16 ft) 2711-NC22 (15 m/49 ft) Null modem required	—	1761-CBL-AP00 (5 m) 1761-CBL-PM02 (2 m) 2711-CBL-PM05 (5 m) 2711-CBL-PM10 (10 m)
DH-485	RS-232 port (9-pin) All terminals	—	2711-NC13 (5 m/16 ft) 2711-NC14 (10 m/32 ft)	2711-NC21 (5 m/16 ft) 2711-NC22 (15 m/49 ft) Null modem required	—	—
	DH-485 port 700 to 1500 terminals only Require 2711P-RN6, 2711P-RN6K	Direct connection to single AIC with Belden 9842 cable <sup>(1)</sup>	—	—	Direct connection to single AIC+ with Belden 9842 cable <sup>(1)</sup>	—

(1) Use serial port on the PanelView Plus 6 terminal with an AIC+ module for a DH-485 network solution.



## Firmware Upgrades

Topic	Page
Terminal Firmware	153
Download Firmware Files	154
Firmware Upgrade Wizard	154
Upgrade Terminal Firmware from a Storage Device	155
Upgrade Terminal Firmware over the Network	158

### Terminal Firmware

Firmware components are packaged as execute-in-place (XIP) regions in a single System Code (SC) .img file. When the SC .img file is copied to the Virtual File System (VFS) on the terminal, the terminal's XIP regions are updated and the terminal restarts automatically. These firmware components are affected during an upgrade:

- FactoryTalk View Machine Edition Station software
- Communication protocols and drivers including Kepware drivers
- Windows fonts
- Windows CE components
- FactoryTalk components
- User extensions

A firmware upgrade does not affect these terminal components or settings:

- Windows registry
- File system including the FactoryTalk View Machine Edition application loaded in the terminal
- Network parameters including the network device name, DHCP-enabled and static IP addressing, speed, and duplex setting
- Display settings
- Screen saver configuration
- Touch-screen calibration

## Download Firmware Files

Download the appropriate firmware installation package from the Rockwell Automation website. The package is named:

PVP6\_<terminal family>\_6.x-yyyymmdd.exe, where:

- <terminal family> is 400-600 or 700-1500
- 6.x is the FactoryTalk View ME software version contained in the package
- yyyymmdd is the date the package was created

This installation package contains the following:

- Firmware Upgrade Package (FUP) contains an autorun executable and the new firmware files.
- Firmware Upgrade Wizard (FUW), version 6.10 or later, is used to upgrade the terminal firmware by using the contents of the FUP.

The FUP and FUW are copied to your computer during the download.

Follow these steps to download firmware installation files to your computer.

1. Go to <http://www.rockwellautomation.com/support> and click the Firmware Updates link.
2. Select Computers & Operator Interface, then PanelView™ Plus.
3. Follow the instructions on the website to locate the firmware installation package for the appropriate PanelView Plus 6 terminals.
4. Download the upgrade file (.exe) to a temporary folder on the same drive as FactoryTalk View Machine Edition (ME) software.
5. Run the upgrade file (.exe) installation procedure:
  - The FUW is installed in the FactoryTalk View ME folder.
  - The firmware upgrade package (.fup) file is installed into the folder specified during the installation procedure.

**TIP** The FUP name is ME\_PVP6xX\_6.x-yymmdd (700 to 1500) or ME\_PVP6xA\_6.x-yymmdd (400 and 600)

- yyyymmdd is the date the firmware package was created
- 6.x is the version of ME contained in this package

You are now ready to run the FUW to upgrade the terminal firmware from a USB flash drive or SD card or by using a network connection.

## Firmware Upgrade Wizard

The Firmware Upgrade Wizard (FUW) is used to upgrade the terminal firmware. Two methods are provided for upgrading the firmware:

- Create a firmware upgrade card with the contents of the FUP file that you can then load in the terminal to upgrade the firmware.

The firmware upgrade card can be a USB flash drive or an SD card, catalog number 1784-SDx.

- Upgrade firmware in a terminal connected to a computer over a direct network connection. The network connection requires a computer running RSLinx Enterprise software, version 5.0 or later. In the RSLinx® Enterprise software, you select the terminal you want to upgrade.

You can run the FUW from within FactoryTalk View Studio software or from the Programs menu on your computer:

- In FactoryTalk View Studio software, from the Tools menu, choose Firmware Upgrade Wizard.
- Choose Start>Programs>Rockwell Software>FactoryTalk View>Tools>ME Firmware Upgrade Wizard.

## Upgrade Terminal Firmware from a Storage Device

Upgrading firmware from a storage device is a two-step process. First, you create a firmware upgrade card with the required firmware files. Secondly, you load the card in the target terminal to upgrade the firmware.

The firmware upgrade card can be a USB flash drive or an SD card.

### Create a Firmware Upgrade Card

Follow these steps to copy firmware files to a USB flash drive or SD card.

1. Insert either a USB flash drive or an SD card into the appropriate slot on your computer.
2. Run the Firmware Upgrade Wizard:
  - In FactoryTalk View Studio software, from the Tools menu, choose Firmware Upgrade Wizard.
  - Choose Start>Programs>Rockwell Software>FactoryTalk View>Tools>ME Firmware Upgrade Wizard.
3. Follow these steps from the initial Firmware Upgrade Wizard dialog box.

- a. Click Create firmware upgrade card.
- b. Select the location of the firmware card by browsing to the root directory of the storage card loaded in your computer for example E:\.  
The firmware files are copied to this location. You can also specify a folder on the hard drive.

- c. From the Existing terminal type pull-down menu, select a version v6.00-v7.00 PanelView Plus 6 terminal.

The example shows the firmware upgrade is for a 700 - 1500 PanelView Plus 6 terminal.

- d. Click Next.

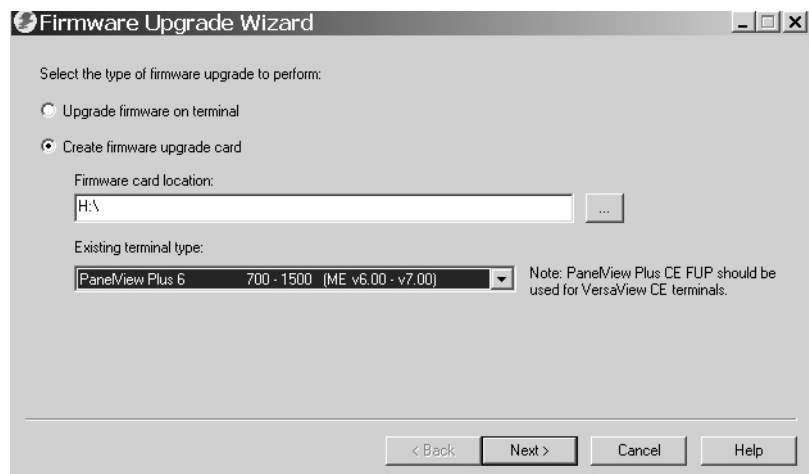

4. Follow these steps from this dialog box.
  - a. Browse to the location of the firmware source files on your computer, where the FUP was installed.
  - b. Choose the firmware revision for the upgrade.
  - c. Click Next.

It can take several seconds for the next dialog box to appear while the FUP is being retrieved.

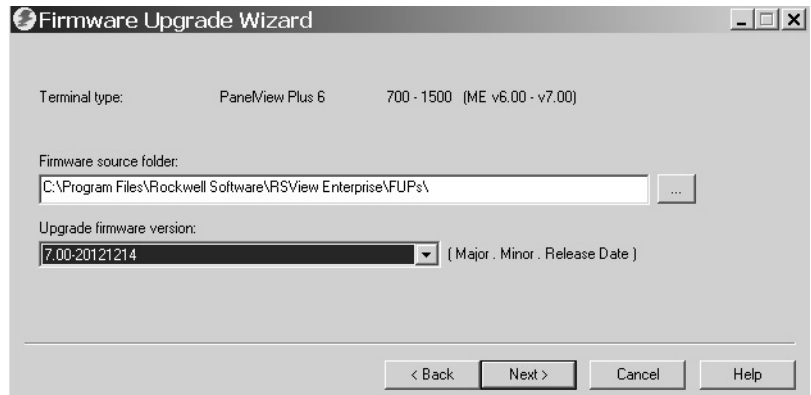

5. From this dialog box, optionally select the KEPServer drivers you want included with the firmware, then click Next.

Keeware drivers are already installed on the PanelView Plus 6 terminals.

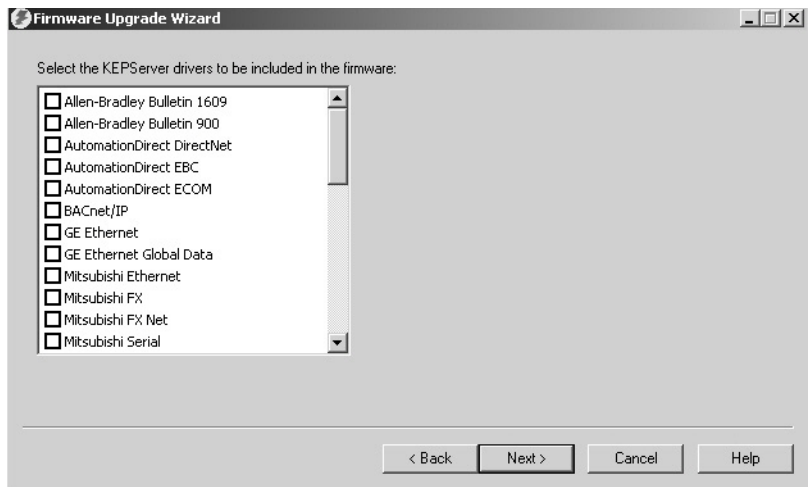

The final dialog box summarizes your choices for creating the firmware upgrade card.

6. Click Finish to copy the firmware files to the firmware upgrade card.

A progress bar automatically updates as files are copied to the USB flash drive or SD card.



7. Click OK when the firmware upgrade completes successfully.

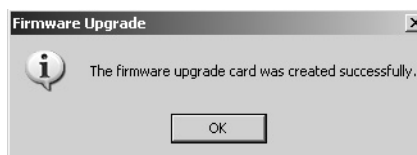

**TIP** If the firmware files were copied to the hard drive, copy the files to the root directory of the USB flash drive or SD card.

8. Remove the USB flash drive or SD card from your computer.
9. Proceed to the next section to use this firmware upgrade card to upgrade the terminal firmware.

## Upgrade Terminal Firmware by Using Firmware Upgrade Card

Follows these steps to transfer firmware files from the USB flash drive or SD card to the terminal. This is the firmware upgrade card created in the previous section.

- 
- IMPORTANT**
- Do not remove or accidentally disconnect the USB flash drive or SD card while a firmware upgrade is in process. This could corrupt the firmware and make the terminal unstable.
  - Do not power off the terminal during a firmware upgrade.
  - USB hubs can produce unexpected behavior and are not recommended.
- 

1. Insert the USB flash drive or SD card into the appropriate slot on your terminal.

The firmware upgrade automatically starts and displays this dialog box.

2. Press Upgrade or [F7] on the terminal to start the firmware upgrade.

The terminal restarts and displays a progress bar during the upgrade.

When the upgrade is complete, the terminal restarts, executing the new firmware.

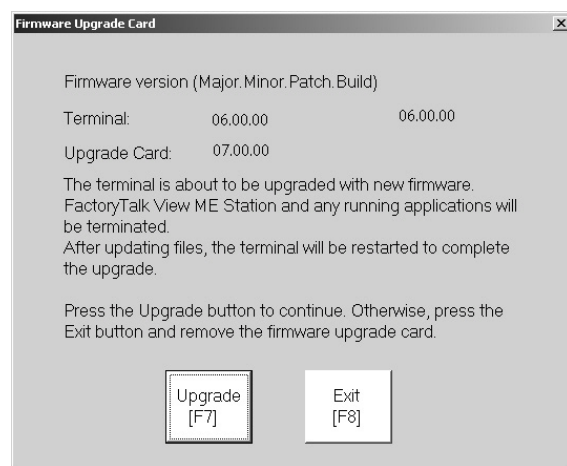

3. Remove the USB flash drive or SD card from the terminal.

- 
- IMPORTANT** If the firmware upgrade fails because of a power loss or the firmware upgrade card is inadvertently removed, you can restore the terminal to the factory default firmware. Refer to [Access Maintenance Operations on page 170](#) for details on how to restore the factory default settings.
-

## Upgrade Terminal Firmware over the Network

You can upgrade firmware in a terminal connected to a computer over a direct network connection. The network connection requires a computer running the Firmware Upgrade Wizard (FUW) and RSLinx Enterprise software, version 5.0 or later.

RSLinx Enterprise software is required so that you can select the terminal on the network.

Follow these steps to copy firmware files to the terminal over a network by using RSLinx Enterprise software and Ethernet communication.

1. Run the Firmware Upgrade Wizard:
  - In FactoryTalk View Studio software, from the Tools menu, choose Firmware Upgrade Wizard.
  - Choose Start>Programs>Rockwell Software>FactoryTalk View>Tools>ME Firmware Upgrade Wizard.
2. Click Upgrade firmware on terminal and click Next.

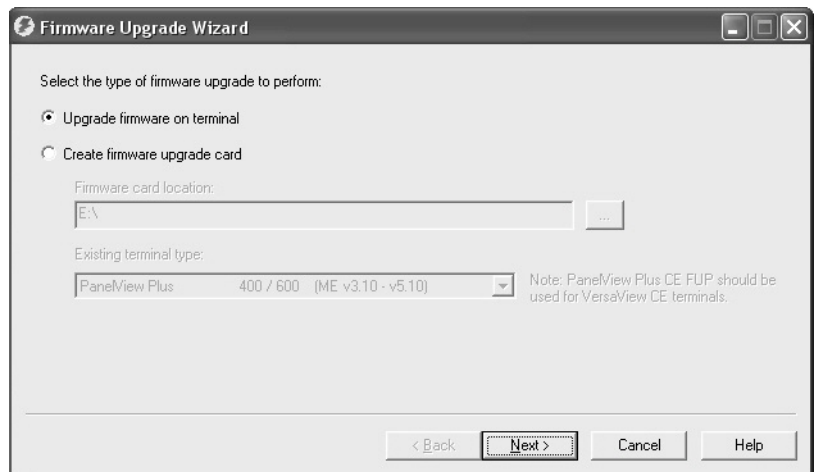

3. Click Yes to continue.

It is not necessary to back up files on PanelView Plus 6 terminals.

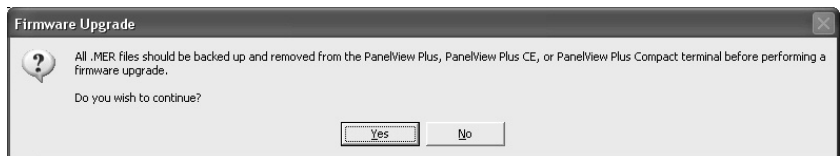

4. Click Network Connection (using RSLinx Enterprise) and click Next.

This is the only valid selection for PanelView Plus 6 terminals.

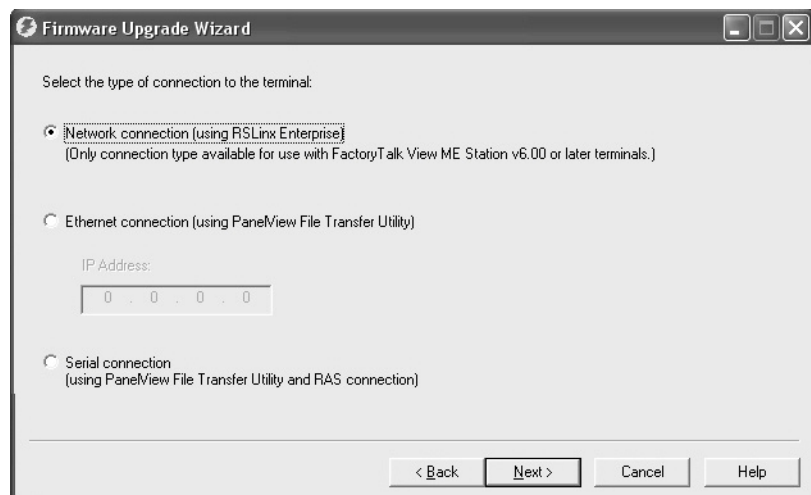

5. Navigate to and select the terminal to receive the firmware update, then click Next.

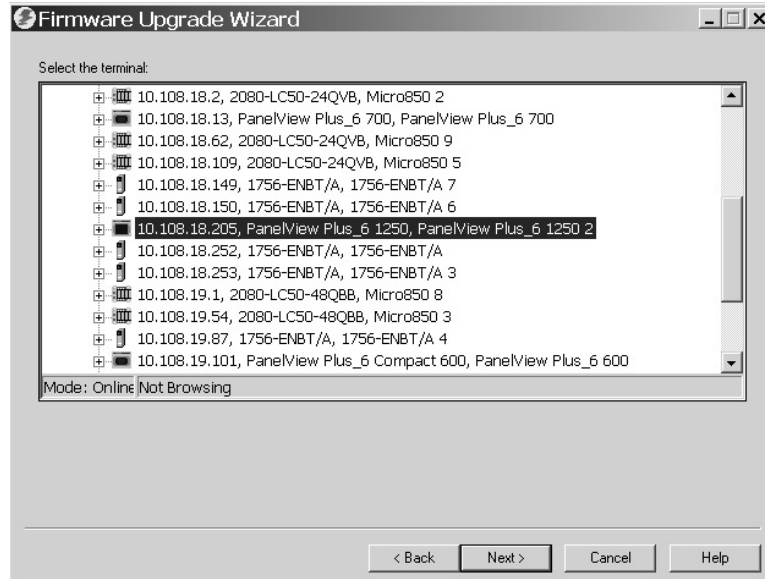

6. Follow these steps from this dialog box.
  - a. Browse to the location of the firmware source files on your computer, where the FUP was installed.
  - b. Choose the version of the upgrade firmware from the pull-down menu.
  - c. Click Next.

The default location is shown.

It can take several seconds for the next dialog box to appear while the FUP is being retrieved.

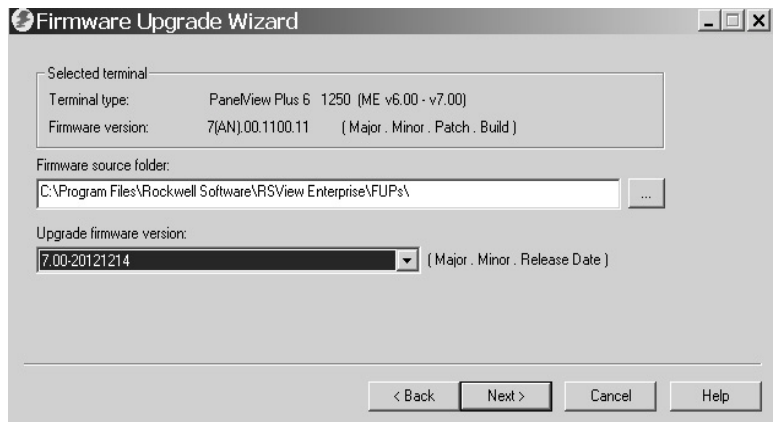

7. From this dialog box, optionally select the KEPServer drivers you want included in the firmware, then click Next.

Kepware drivers are already installed on the PanelView Plus 6 terminals.



The final dialog box summarizes your choices for upgrading the terminal firmware.

- Click Finish to update the firmware in the terminal.

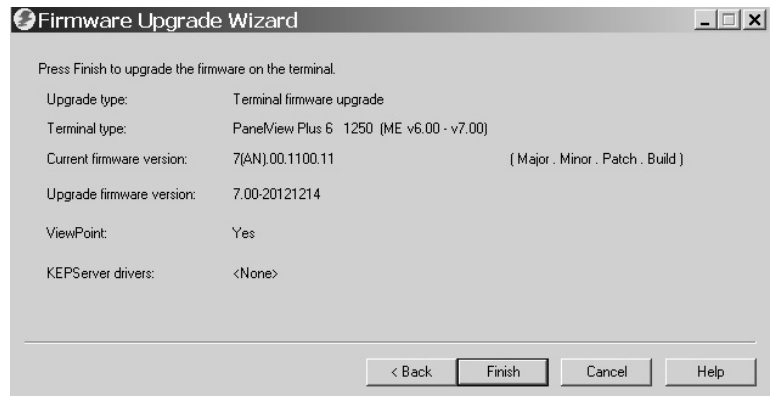

- Click Yes to continue with the update.

A progress bar updates as firmware files are copied to the terminal.

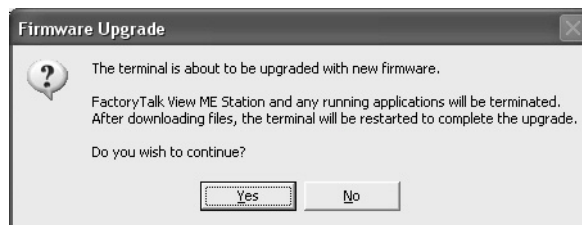

- Click OK when the firmware upgrade is complete.

The terminal restarts, executing the new firmware.



---

**IMPORTANT** If the firmware upgrade fails because of a power loss or some other reason, you can restore the terminal to the factory default firmware. Refer to [Access Maintenance Operations on page 170](#) for details on how to restore the factory default settings.

---



## Troubleshooting

Topic	Page
Status Indicators	161
Terminal Does Not Start Properly	162
Start-up Messages and Codes	164
Check Terminal Components	166
Ethernet Connection	167
Program Launcher ActiveX Control	168
Application Does Not Run	168
Configuration Mode Access	168
File System Errors	169
Advanced Diagnostics	169
Access Maintenance Operations	170
Restore Factory Defaults	172

### Status Indicators

The terminals have two status indicators to isolate operating anomalies:

- COMM indicator (green) for communication
- FAULT indicator (red) for hardware and firmware faults

Figure 25 - Status Indicators

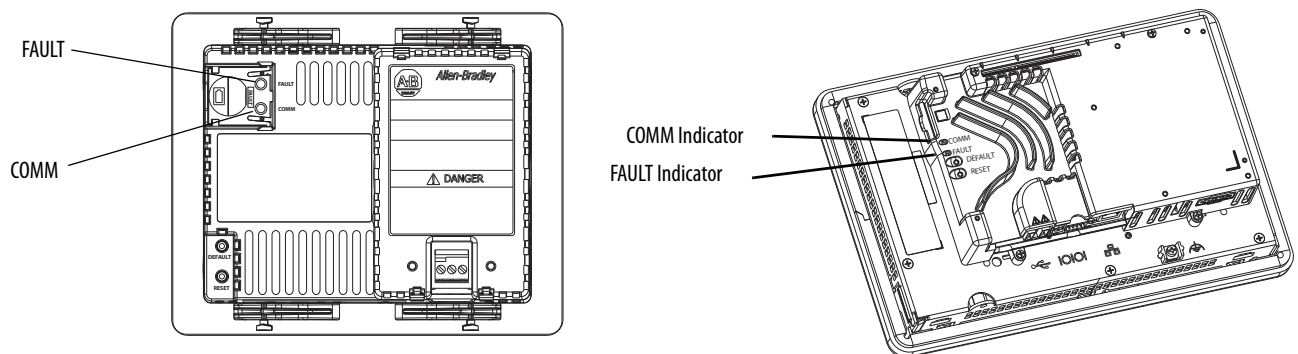

## Terminal Does Not Start Properly

This section provides general troubleshooting information to assist you when trying to isolate anomalies.

### Check for Adequate Power

A terminal that does not receive adequate power could result in unpredictable behavior. Refer to [Chapter 2](#) for power requirements.

### Check Indicators at Startup

When the terminal starts, the fault and comm indicators flash on and off, then the comm indicator flashes to signal progress during startup. When startup is complete, the comm indicator remains on, and is controlled by the communication driver or application. The comm indicator typically flashes when communication is active.

If the indicators remain off, the power supply or logic module has failed. Check the power cable:

- If the power is not within range, replace the power supply.
- If the power is within range, replace the logic module or terminal.

The table shows indicator states if the terminal powers on and stops during startup.

**Table 78 - Indicator States if Terminal Stops during Startup**

Fault (Red) Indicator	Comm (Green) Indicator	Description
Blinking	Off	Recoverable firmware error. Last firmware download failed. Reload the firmware by using the Firmware Upgrade Wizard (FUW).
On	Off	Non-recoverable hardware fault with logic module: <ul style="list-style-type: none"> <li>• For 400 and 600 terminals, replace the terminal.</li> <li>• For 700 to 1500 terminals, replace the logic module.</li> </ul>
	Blinking	Non-recoverable hardware fault with display module: <ul style="list-style-type: none"> <li>• For 400 and 600 terminals, replace the terminal.</li> <li>• For 700 to 1500 terminals, replace the display module.</li> </ul>

## Check the Start-up Messages and Codes

Refer to [Start-up Messages and Codes on page 164](#) for a list of message states and error codes that can appear on the splash screen during startup.

## Check Voltages and Temperatures

Check the battery voltage, processor temperature, and display temperature.

**Table 79 - Checking Voltage and Temperature Conditions**

Check for These Conditions		Where	What to Do
Battery voltage	< 2.75V DC	<ul style="list-style-type: none"> <li>From terminal desktop: Refer to <a href="#">Battery Voltage on page 92</a></li> <li>From FactoryTalk View ME Station Configuration mode: Refer to <a href="#">View Terminal Information on page 74</a></li> </ul>	Replace the battery if needed.
CPU temperature	>95 °C (203 °F)	<ul style="list-style-type: none"> <li>From terminal desktop: Refer to <a href="#">Temperatures on page 92</a></li> <li>From FactoryTalk View ME Station Configuration mode: Refer to <a href="#">View Terminal Information on page 74</a></li> </ul>	Check for obstructed airflow in the chassis and attempt to moderate the ambient temperatures within the enclosure and surroundings.
Display temperature	>55 °C (131 °F)	<ul style="list-style-type: none"> <li>From terminal desktop: Refer to <a href="#">Temperatures on page 92</a></li> <li>From FactoryTalk View ME Station Configuration mode: Refer to <a href="#">View the Display Temperature on page 65</a></li> </ul>	

## Check the System Event Log

Check the system event log for errors or unexpected behaviors:

- From FactoryTalk® View ME Station Configuration mode, press Terminal Settings>System Event Log. Refer to [View and Clear the System Event Log on page 74](#).
- From the control panel, open the Hardware Monitor and click the System Event Log tab. Refer to [System Event Log on page 91](#).

**Start-up Messages and Codes** The splash screen reports actions and status conditions that occur during startup. This includes firmware and hardware revision information.

**Figure 26 - Start-up Splash Screen**

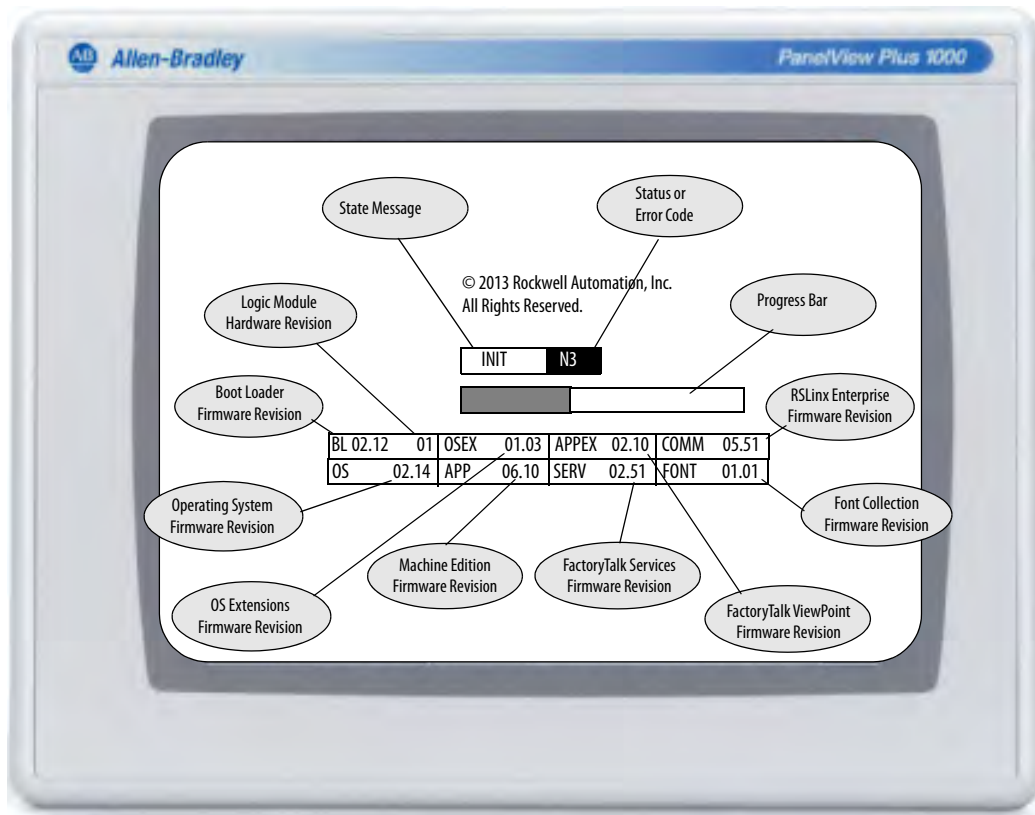

This table lists messages associated with each state and the corresponding status or error codes.

**Table 80 - Start-up Messages and Codes**

State Message Description	State Message	Code	Recommended Action
<b>Common Start-up Messages</b>			
Boot loader attempting PC connection via USB device	AutoTest	OA	Messages during this phase of startup are for information purposes only.
Boot loader loads firmware image into RAM	AutoTest	E6	
Boot loader jumps to operating system	AutoTest	FF	
Operating system starts up	Boot	G0	
Operating system registration and initialization	Init	H1 - JA	
Machine Edition registration and initialization	Init	K1 - MA	
Machine Edition load and execute	Init	ME	

**Table 80 - Start-up Messages and Codes**

State Message Description	State Message	Code	Recommended Action
<b>Firmware Installation and Loading</b>			
Load firmware image into RAM	Update	1E	Messages during firmware installation and loading are for information purposes only.
Write firmware image to storage	Update	A5	
Load factory-default firmware image into RAM	Restore	E6	
Write factory-default firmware image to storage	Restore	A5	
Restore factory-default configuration data	Restore	DC	
Firmware validation (CRC/format) failure	Fatal	1E	A fatal error during firmware installation or loading is usually recoverable by doing one of the following: <ul style="list-style-type: none"> <li>Reset terminal from maintenance menu</li> <li>Restore factory defaults from maintenance menu</li> <li>See <a href="#">page 172</a> for details on how to perform a restore.</li> <li>Re-install firmware</li> </ul> Refer to <a href="#">Access Maintenance Operations on page 170</a> for details on resetting terminal and restoring factory defaults.
Firmware failed to validate compatibility index of a firmware region	Fatal	1F	
Firmware update failure	Fatal	0F	
Firmware write to storage failure	Fatal	A5	
Firmware stored image verification failure	Fatal	D2	
Invalid or missing OS firmware image	Fatal	FF	
<b>Power on Self-test (POST) Failures</b>			
Failed RAM	Fatal	03	A fatal error during POST is usually due to failed hardware: <ul style="list-style-type: none"> <li>For failed RAM, replace the logic module (700 to 1500) or the terminal (400 and 600).</li> <li>For stuck key, stuck touch, and failed backlight, replace the display module.</li> </ul>
Stuck key	Fatal	31	
Stuck touch	Fatal	3A	
Failed backlight	Fatal	3B	
<b>Restore Operation Failures</b>			
Failed to initialize restore operation	Fatal	R0	A fatal error during a restore operation is usually recoverable by resetting the terminal from the maintenance menu. Refer to <a href="#">Access Maintenance Operations on page 170</a> for details on resetting the terminal.
Failed restore because of invalid header in .pvb file	Fatal	R1	
Failed restore because of invalid header	Fatal	R2	
Failed restore because of inability to write intermediate files to terminal	Fatal	R3	
Failed restored because of corrupt .pvb file	Fatal	R4	
<b>Watch Dog</b>			
Watch dog reset	Fatal	02	A watch dog reset is usually a momentary loss of control due to a software failure. Monitor this error for recurrence and remedial action.

## Check Terminal Components

This section provides tips on how to isolate anomalies with the display, touch screen, keypad, attached keyboard, or mouse. If you are unable to resolve the anomaly, replace the touch screen display module (700-1500) or the terminal (400-600).

**Table 81 - Resolve Anomalies with Touch Screen**

Symptom	Recommended Action
The display does not have a touch screen.	Check the catalog number of the unit. Verify that your display is a touch screen by looking at the label on the terminal.
The touch screen is not operating correctly.	Calibrate the touch screen: <ul style="list-style-type: none"> <li>In FactoryTalk View ME Station Configuration mode, press Terminal Settings&gt;Input Devices&gt;Touch Screen&gt;Calibration.</li> <li>From the control panel on the terminal desktop, open the Touch dialog box and click the Calibration tab.</li> </ul>
Touch input and dragging is inaccurate. The touch screen is present and working but requires calibration.	The calibration requires five screen touches. When the touches do not converge to a satisfactory calibration, you are asked repeatedly for additional screen touches. The process continues until a valid calibration is performed. A touch screen that does not calibrate is not present or is not functioning properly. Replace the touch screen display module (700-1500) or the terminal (400-600).
The screen cursor is not visible.	Verify that the cursor is enabled: <ul style="list-style-type: none"> <li>In FactoryTalk View ME Station Configuration mode, press Terminal Settings&gt;Display&gt;Cursor.</li> <li>From the control panel on the terminal desktop, open Display and click the Advanced tab.</li> </ul>
The touch screen does not accept touch input.	Attach a USB mouse to check whether the anomaly is with the touch screen or the application: <ul style="list-style-type: none"> <li>If the mouse works, but the touch screen does not, then the touch driver or touch screen is not functioning.</li> <li>If both the mouse and the touch screen are not working, then it is an application issue.</li> </ul>

**Table 82 - Resolve Anomalies with Display**

Symptom	Recommended Action
The display is dim or unreadable.	Check the brightness setting: <ul style="list-style-type: none"> <li>In FactoryTalk View ME Station Configuration mode, press Terminal Settings&gt;Display&gt;Display Intensity.</li> <li>From the control panel on the terminal desktop, open Display and click the Backlight tab.</li> </ul>
The backlight is turning off or dimming the display unexpectedly.	Check the screen saver settings: <ul style="list-style-type: none"> <li>In FactoryTalk View ME Station Configuration mode, press Terminal Settings&gt;Display&gt;Screen Saver.</li> <li>From the control panel on the terminal desktop, open Display and click the Screen Saver tab.</li> </ul>
A start-up error appears during startup.	Record the message and check the start-up error messages table on <a href="#">page 164</a> .

**Table 83 - Resolve Anomalies with Mouse**

Symptom	Recommended Action
The mouse is not operating correctly.	Check the USB cable and connection. Detach and then reattach the mouse. Cycle power to the terminal.
The screen cursor is not be visible or the mouse settings need adjusting.	Check if the screen cursor is disabled: <ul style="list-style-type: none"> <li>In FactoryTalk View ME Station Configuration mode, press Terminal Settings&gt;Display&gt;Cursor.</li> <li>From the control panel on the terminal desktop, open Display and click the Advanced tab.</li> </ul> Check the mouse setting: <ul style="list-style-type: none"> <li>In FactoryTalk View ME Station Configuration mode, press Terminal Settings&gt;Input Devices&gt;Mouse.</li> <li>From the control panel on the terminal desktop, open the Mouse dialog box.</li> </ul>
The mouse is a USB composite device (keyboard + mouse).	Attach a standalone USB mouse. For a list of compatible USB devices, go to the knowledgebase at the Rockwell Automation technical support site <a href="http://www.rockwellautomation.com/knowledgebase">http://www.rockwellautomation.com/knowledgebase</a> and search for ID 115072.
The USB mouse does not work.	The mouse can be noncompliant. Replace the USB mouse. Try a different model or manufacturer. If attaching a new mouse resolves the anomaly, then the old mouse was noncompliant. For a list of compatible USB devices, go to the knowledgebase at the Rockwell Automation technical support site <a href="http://www.rockwellautomation.com/knowledgebase">http://www.rockwellautomation.com/knowledgebase</a> and search for ID 115072.

**Table 84 - Resolve Anomalies with Keyboard**

Symptom	Recommended Action
The keyboard is not operating correctly.	Check the USB cable and connector. Detach and reattach the keyboard. Verify a good connection. Cycle power to the terminal.
The keyboard is not accepting key input.	Check key input by using the keypad: <ul style="list-style-type: none"> <li>• If the keypad works, but the keyboard does not, then the keyboard driver or keyboard is not working.</li> <li>• If both the keypad and keyboard are not working, then the issue is probably an application failure.</li> </ul> Issues with keyboard input can be the fault of the application. <ul style="list-style-type: none"> <li>• Press a key outside the application such as an edit box in the shell. If the keypad works outside the application, then the application is at fault.</li> <li>• Press Ctrl+Esc simultaneously to open the Start menu, cursor to run, type numbers and viewable characters into the Run dialog box.</li> </ul>
The keyboard is a USB composite device (keyboard + mouse).	Attach a standalone USB keyboard.
The USB keyboard does not work.	The keyboard can be noncompliant. Replace the USB keyboard. Try a different model or manufacturer. If a new keyboard resolves the issue, then the old keyboard was probably noncompliant. For a list of compatible USB devices, go to the knowledgebase at the Rockwell Automation technical support site <a href="http://www.rockwellautomation.com/knowledgebase">http://www.rockwellautomation.com/knowledgebase</a> and search for ID 115072.

## Ethernet Connection

This table provides tips on how to isolate Ethernet anomalies.

**Table 85 - Resolve Ethernet Anomalies**

Action	Description
Check the status indicators at the Ethernet connection	<ul style="list-style-type: none"> <li>• Green indicates a communication link and is normally on.</li> <li>• Yellow indicates data activity and is normally flashing.</li> </ul>
Check cable connections and quality of cable	Check for the following: <ul style="list-style-type: none"> <li>• Cable crimping</li> <li>• Ethernet hub/switch connection</li> <li>• Uplink ports</li> </ul>
Check the IP Address of the Built-in Ethernet Controller	<ul style="list-style-type: none"> <li>• From FactoryTalk View ME Station, select Terminal Settings&gt;Networks and Communications&gt;Network Connections&gt;Network Adapters.</li> <li>• From the control panel on the terminal desktop, open Network and Dial-up Connections.</li> </ul> If DHCP is enabled, the device expects a valid IP address to be acquired within several seconds after startup. The TCP/IP protocol automatically assigns 169.254.nnn.nnn when it fails to acquire an IP address from the server. In general, an IP address that begins with 169 does not support a network connection. A bad Ethernet connection and the absence of a valid IP address are typically reported in a Communication error message box with the Winsock critical error 10065 - No route to host.
Check for conflicting IP addresses	If DHCP is not enabled, make sure the IP address of the terminal is not in conflict with the address of another device on the network.
Check the device name of the terminal	Devices on the network must not have the same host name: <ul style="list-style-type: none"> <li>• In FactoryTalk View ME Station, select Terminal Settings&gt;Communications and Networks&gt;Network Connections&gt;Device Name.</li> <li>• From the control panel on the terminal desktop, open the System applet and click the Device Name tab.</li> </ul>
Contact your Network Administrator to check peer or server settings	The other side of the Ethernet connection can be an issue.
Check the requirements of network applications	Network applications can have specific requirements such as Proxy Settings for Internet Explorer and Ethernet Configuration for ActiveSync.
Check multi-homed devices	Multi-homed devices, more than one Ethernet node, can cause confusion and ambiguity. Keep the network connections as simple as possible.
From the desktop, use the network tools Ping.exe and Ipconfig.exe to diagnose issues with IP addresses and host devices.	These network utilities are diagnostic tools: <ul style="list-style-type: none"> <li>• Ping is an Internet utility used to determine whether a particular IP address is reachable online by sending out a packet and waiting for a response. Ping is used to test and debug a network as well as see if a user or server is online.</li> <li>• Ipconfig is a Windows command line utility that manages the IP address assigned to the machine it is running in. It displays the computer's currently assigned IP, subnet mask and default gateway addresses.</li> </ul>

## Program Launcher ActiveX Control

If desktop access is restricted and you use the Program Launcher - ActiveX control to launch a file viewer, text editor, or PDF reader, the system locks up when you try to open a file.

To avoid this issue, associate a file with the application you are launching. The viewer, editor, or PDF reader automatically launches with the associated file.

## Application Does Not Run

If a terminal application does not run at startup, there can be an issue with the FactoryTalk View Machine Edition (ME) application:

- Verify that a start-up screen was configured and that the runtime file is a compatible version.
- Try to run the application manually. If the application runs manually, then the operating system can be starting up with an invalid shortcut path. Check the shortcuts in the Windows Startup folder.

`\Windows\StartUp`

Check the syntax of each shortcut path in the Startup folder and verify that a valid target application exists.

- Check that the application is not missing components or required DLLs. Remove and reload the application.

## Configuration Mode Access

To access Configuration mode while an application is running, your FactoryTalk View ME application must contain a screen with a Goto Configuration Mode button. When the application is running, you can press this button to access Configuration mode.

If a running application does not contain a Goto Configuration Mode button, you can access Configuration mode during startup in one of two ways:

- Enter Safe mode from the general Maintenance screens. Refer to [page 170](#) for details.
- Detect a Safe mode request at startup by enabling this start-up option in the System dialog box of the control panel. Refer to [page 98](#) for details.

**TIP** If the terminal is configured to enter Configuration mode at startup and does not, then reload the firmware.



## File System Errors

File system errors are rare as the internal file system is transaction safe. Always stop applications before removing power so that data is cleanly flushed out to the file system and the file system is brought to an orderly stop.

Do not remove the external USB or SD storage devices while writing to the device is in progress. Although the FactoryTalk View Machine Edition (ME) application runs from RAM, functions such as data logging, event logging, and historical trending, write to nonvolatile memory and must be stopped before removing power.

## Advanced Diagnostics

Ping and ipconfig are valuable tools for network debugging along with some knowledge of IP and the Winsock error codes:

- Try to ping the destination host.
- Check the destination address.
- Check whether you have a router configured in your network system (your WinSock implementation).
- Use the tracert command at the command prompt on the desktop to try and determine where the failure occurs along the route between your host and the destination host.

Other diagnostic tips that can help include the following:

- Take advantage of alternate connectivity - mouse versus touch screen, keyboard versus keypad, serial communication, and alternate Ethernet connections.
- Examine the folder \Windows\DumpFiles for crash logs when suspecting an application or operating system crash.

The crash dump file is viewable offline, on a workstation, by using common Windows development or debugging tools, for example, Visual Studio or WinDBG. At a minimum, the information in the crash dump file reveals the date and time of the exception, the exception type, the name of the offending process and the register state, including the program counter.

- Store Autorun.exe utilities on an SD card that can be easily run by inserting the card in the SD card slot of the terminal.
- Know useful keyboard shortcuts so that you can navigate around the system without a mouse or touch screen.
- Check the system event log in the Hardware Monitor control panel application or under Terminal Settings>System Event Log in FactoryTalk View ME Configuration mode. Look for error conditions or reasons that can cause unexpected behaviors or restarts.
- Check the configuration settings in the control panel on the terminal desktop or in FactoryTalk View ME Configuration mode.

## Access Maintenance Operations

The terminal typically launches the Windows desktop or a FactoryTalk View ME application on startup. You can also start the system in Maintenance mode for diagnostic and repair purposes.

**Table 86 - Maintenance Start-up Operations**

Operation	Description
None	Exits Maintenance mode and continues with a normal restart.
Safe mode	Starts the system in Safe operating mode. This is a diagnostic mode with reduced functionality that lets you recover from a software anomaly. In Safe mode, you can repair offending applications or changes that caused the anomaly. <b>Important:</b> FactoryTalk View ME Station software does not run the HMI .mer application on startup if one is loaded, but instead enters Configuration mode. The HMI application runs the next time the system is reset.
Restore factory defaults	Restores all storage media on the terminal to its initial factory default state, including firmware, registry, file system, and configuration data. Typically, this option is used to recover from a failed firmware upgrade. <b>Important:</b> All storage media is returned to its original state when purchased. All user-installed, firmware updates are removed. See <a href="#">Restore Factory Defaults on page 172</a> for details on how to perform a restore.
Reset terminal	Restores all user-accessible storage and configuration data on the terminal to its default state. The current firmware revision is retained. <b>Important:</b> All storage media is returned to its original state when purchased except for the firmware. The latest FactoryTalk View ME image is retained. All user data changes or additions are lost.
Display resolution (700 to 1500 terminals only)	Sets the display resolution at startup. If the system can't detect the resolution, you can choose the appropriate resolution by terminal model. <ul style="list-style-type: none"> <li>• Auto - auto detects the display resolution.</li> <li>• VGA - sets the resolution to 640x480x16 for the 700 and 1000 terminals.</li> <li>• SVGA - sets the resolution to 800 x 600 x 16 for the 1250 terminals.</li> <li>• X VGA - sets the resolution to 1024 x 768 x 16 for the 1500 terminal.</li> </ul> The 400 and 600 displays are 320x240 QVGA.

Perform the maintenance operations **in this order** to diagnose and repair operating problems with your terminal.

1. Safe mode - stops an application from starting automatically.
2. Reset terminal - removes user-installed applications, user-configuration changes, and user-accessible data.
3. Restore factory defaults - returns the terminal to its original, out-of-box state.

## Access Maintenance Operations

Follow these steps to access Maintenance actions at startup.

**TIP** Terminals require an attached USB keyboard to navigate in Maintenance mode.

1. Insert a thin, nonconductive probe into the hole marked Default on the back of the logic module and press the switch.

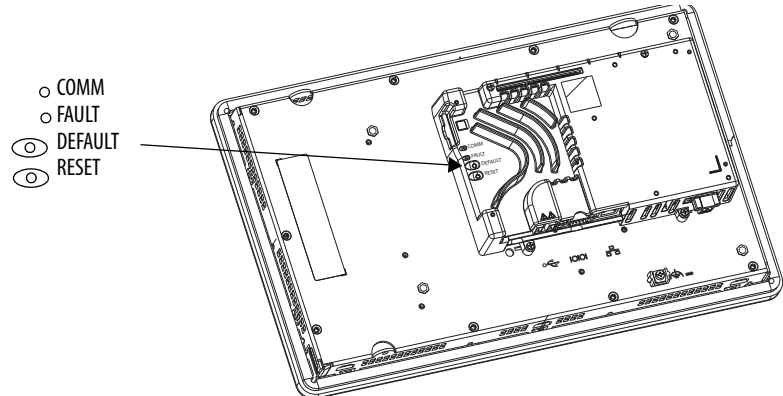

**TIP** To access this menu from a fault state, press the Reset switch, then press and hold the Default switch until you see the menu.

The terminal restarts in Maintenance mode with the display brightness set to 100%. Refer to [Table 86 on page 170](#) for a description of maintenance operations.

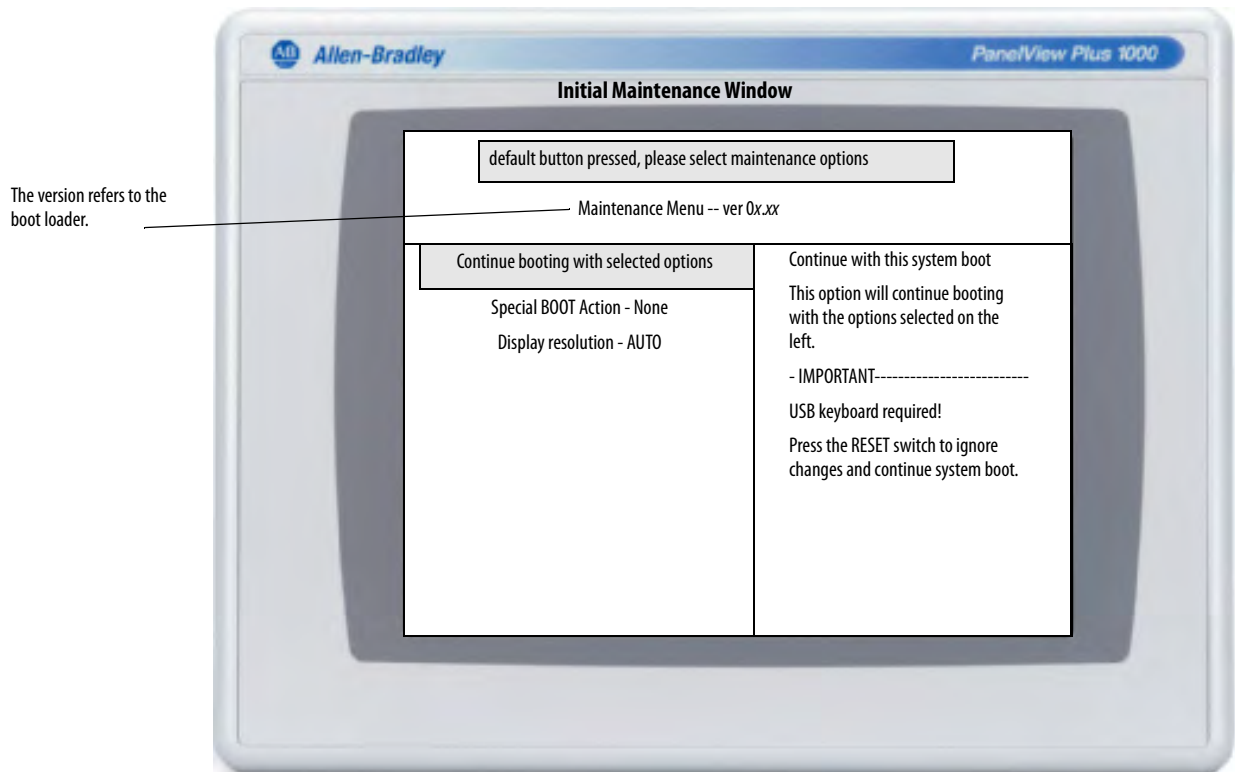

**TIP** Use the keys at the bottom of window to make selections.

2. Press the up and down arrow keys on the keypad or attached keyboard to move up and down the list of maintenance options:
    - Continue booting with selection option.
    - Special Boot Action
    - Display Resolution (not on 400 and 600 terminals)
  3. With an option selected, press the right or left arrow keys to cycle through the available operations or settings.
- The result of each action is explained on the right.

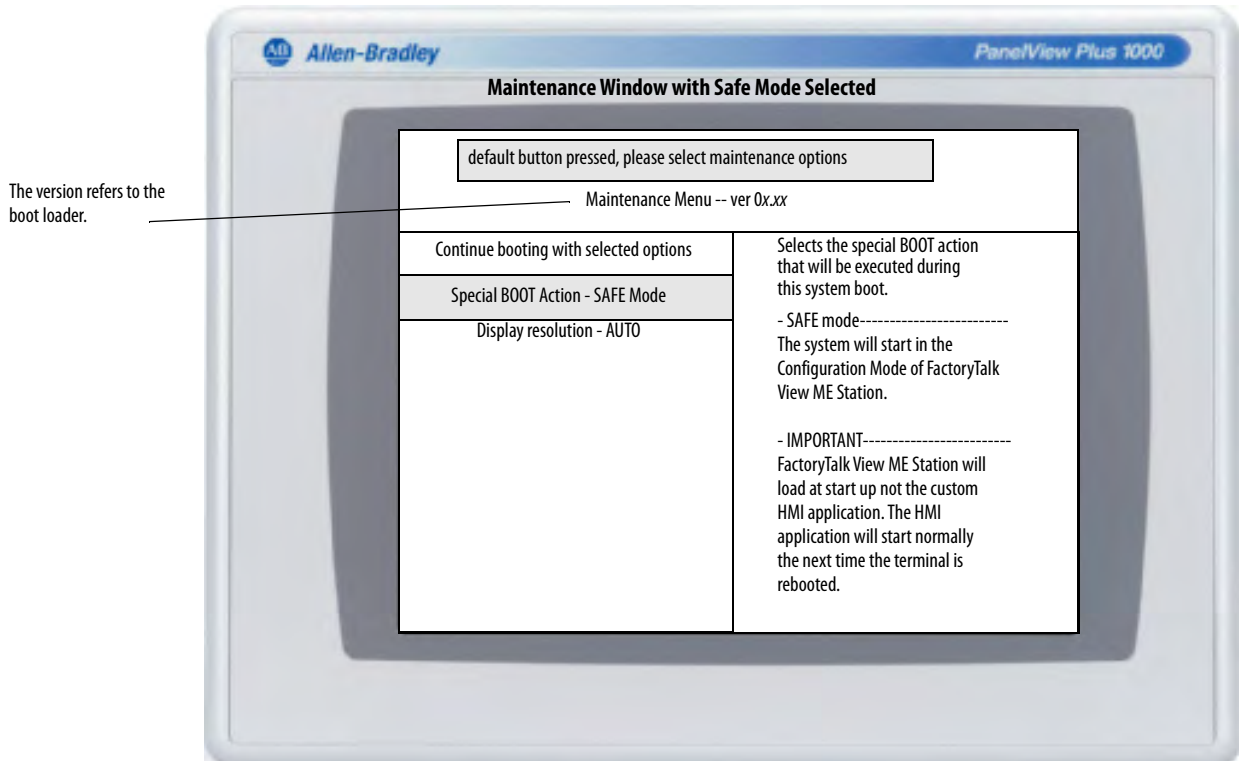

4. Follow these steps, when done making selections.
  - a. Press the up arrow to return to 'Continue booting with selected options'.
  - b. Press the Enter key to continue booting.

## Restore Factory Defaults

To recover from a firmware update failure, for example, fatal code 0F, you need to restore your terminal to its out-of-box, factory default state.

Follow these steps to restore factory defaults from Maintenance mode.

**TIP** Terminals require an attached USB keyboard to navigate in Maintenance mode.

1. While pressing and holding the Default switch on the back of the logic module, press and release the Reset switch.

After releasing the Reset switch, release the Default switch to enter the maintenance menu.

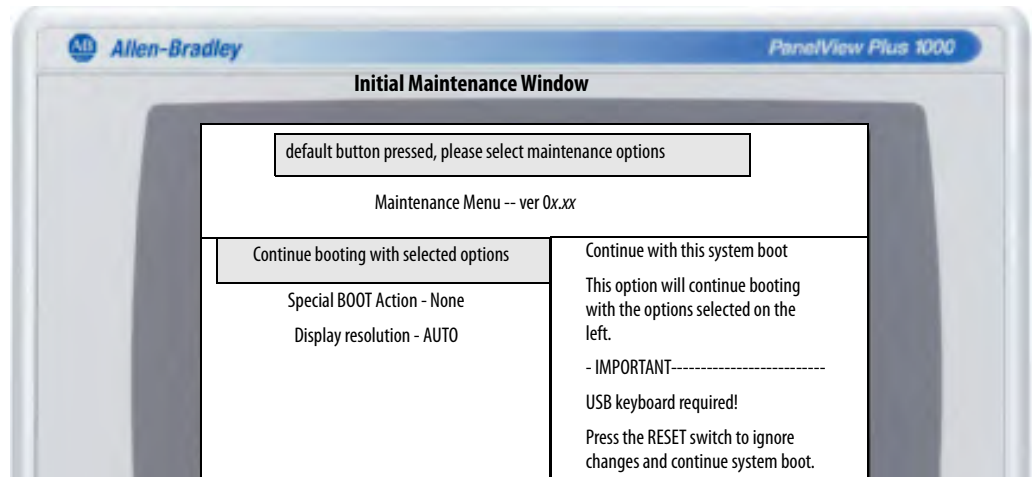

**TIP** Use the keys at the bottom of window to make selections.

2. Press the down arrow on the keyboard to select the following option:  
Special BOOT Action -None
3. Press the right arrow three times to select the following option:  
Special BOOT Action - Restore Factory Defaults.

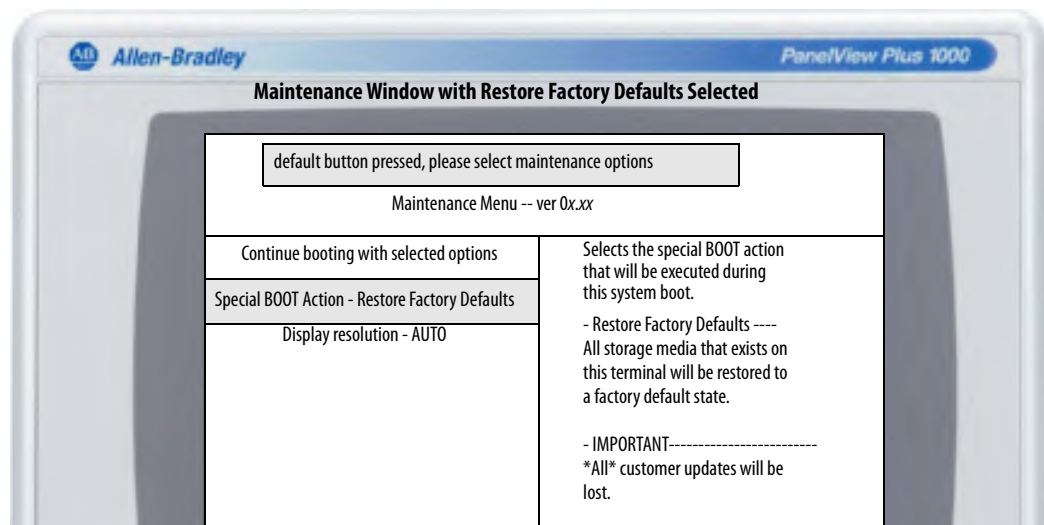

4. Press the up arrow to select “Continue booting with selected options”.
  5. Press Enter on your keyboard to initiate the factory default restore process.
- The terminal is returned to its out-of-box state, including the firmware, registry, file system, and storage areas. All user data is lost after the restore.

**Notes:**

## Fonts Resident on Terminal

### True Type Fonts

The table lists true type fonts that are pre-installed on the terminals. The default system font is Tahoma.

**TIP** The Arial Unicode MS font contains almost 50,000 characters and provides default language support for many non-Latin languages and scripts including Arabic, Hebrew, Vietnamese, Thai, Hindi (Devanagari), and other Indic languages. The font also includes Chinese, Japanese, and Korean (CJK) support.

You can load additional fonts on the system by copying the font files to the \Windows\Fonts folder on the terminal desktop. To access this folder, select the My Device icon on the terminal desktop or choose Start>Programs>Windows Explorer.

**Table 87 - True Type Fonts**

True Type Fonts	File Name
Arial Unicode MS version 1.01	arialuni.ttf
<b>Latin Fonts</b>	
Arial	
Arial (Subset 1_30)	arial_1_30.ttf
Arial Black	arialk.ttf
Arial Bold	arialbd.ttf
Arial Bold Italic	arialbi.ttf
Arial Italic	ariali.ttf
Comic Sans MS	
Comic Sans MS	comic.ttf
Comic Sans MS Bold	comicbd.ttf
Courier New	
Courier New (Subset 1_30)	cour_1_30.ttf
Courier New Bold	courbd.ttf
Courier New Bold Italic	courbi.ttf
Courier New Italic	couri.ttf
Georgia	
Georgia	georgia.ttf
Georgia Bold	georgiab.ttf
Georgia Bold Italic	georgiaz.ttf
Georgia Italic	georgiai.ttf
Impact	impact.ttf
Kino	kino.ttf

**Table 87 - True Type Fonts**

<b>True Type Fonts</b>	<b>File Name</b>
Microsoft Logo	mslogo.ttf
Symbol	symbol.ttf
Tahoma	
Tahoma (Subset 1_07)	tahoma_1_07.ttf
Tahoma Bold	tahomabd.ttf
Times New Roman	
Times New Roman (Subset 1_30)	times_1_30.ttf
Times New Roman Bold	timesbd.ttf
Times New Roman Bold Italic	timesbi.ttf
Times New Roman Italic	timesi.ttf
Trebuchet MS	
Trebuchet MS	trebuc.ttf
Trebuchet MS Bold	trebucbd.ttf
Trebuchet MS Bold Italic	trebucbi.ttf
Trebuchet MS Italic	trebucit.ttf
Verdana	
Verdana	verdana.ttf
Verdana Bold	verdanab.ttf
Verdana Bold Italic	verdanaz.ttf
Verdana Italic	verdanai.ttf
Webdings	webdings.ttf
Wingding	wingding.ttf
PanelView Fonts	
PV 12 x 24, PV 12 x 8	PV12x24.ttf, PV12x8.ttf
PV 16 x 24	
PV 18 x 16, PV 18 x 8	
PV 24 x 32	
PV 32 x 40, PV 32 x 64	
PV 4 x 6	
PV 6 x 16, PV 6 x 24, PV 6 x 8, PV 6 x 9	
PV 8 x 16, PV 8 x 20, PV 8 x 24	
PV Double High	PVdouble_high.ttf
PV Double Wide	PVdouble_wide.ttf
PV Extra Large	PVextra_large.ttf
PV Large	PVlarge.ttf
PV Small	PVsmall.ttf
PV Tiny	PVtiny.ttf
PV Very Tiny	PVvery_tiny.ttf
East Asian Fonts	
Gulim version 2.21 - Korean	gulim.ttc
MS Gothic version 2.30 - Japanese	gulim.ttc



---

## Outdoor Installations for High-bright Displays

### Important Considerations

When using a high-bright display module outdoors, catalog number 2711P-RDT12H, there are important considerations in maximizing the field-life of the front bezel and display:

- Using an antiglare overlay and visor
- Selecting the proper enclosure
- Using the proper orientation of the terminal

Ultraviolet and infrared radiation can reduce the field life of any electronic device. While the materials used in the terminal bezels provide long field life, that field life can be extended by proper installation.

---

<b>IMPORTANT</b>	The high-bright display module is compatible only with DC-powered logic modules, catalog numbers 2711P-RP8D, 2711P-RP8DK, 2711P-RP9D, 2711P-RP9DK. It cannot be used with AC-powered logic modules.
------------------	---

---

### Using an Antiglare Overlay

Ultraviolet (UV) radiation from the sun causes all plastics to fade or yellow, and become brittle over time. Using an antiglare overlay, catalog number 2711P-RGT12, protects the front of the terminal from direct exposure to UV radiation and increase its field life.

### Using a Solar Visor

If the high-bright display module is in direct sunlight during the hottest part of the day and the external ambient temperature exceeds 40 °C (104 °F), use the visor kit, catalog number 2711P-RVT12. The visor reduces the solar load on the front of the display and helps to maintain temperatures within specification.

The high-bright display module has a built-in temperature sensor that automatically reduces the backlight intensity if the temperature inside the cabinet exceeds 55 °C (131 °F). This reduces the risk of damage to the display.

## Selecting an Enclosure

The paint, color, size, and power dissipated by the internal components of an enclosure affect the temperature rise inside the cabinet. Hoffman, a Rockwell Automation Encompass™ Partner, has information to help you select an enclosure, and heating/cooling accessories to meet the temperature requirements of the installed equipment. See <http://www.hoffmanonline.com>.

Stirring fans or active cooling be required in high altitude and high ambient temperature locations to keep the internal enclosure temperature below 55 °C (131 °F). Use a heater in installations where the ambient temperature is below 0 °C (32 °F).

## Backlight Considerations

The backlight of the high-bright display generates a significant amount of heat when set to full intensity. To minimize the amount of heat generated and extend the life of the backlight, decrease the display intensity by using the screen saver with a 5...10 minute delay.

## Orientation of the Terminal

If outside, avoid placing the terminal on the south (north in the southern hemisphere) or west side of a cabinet, if possible. This reduces the heat rise due to solar loading during the hottest part of the day.

Mount the terminal vertically to minimize solar loading on the display. Do not mount the terminal in a sloped enclosure if it is exposed to direct sunlight.

**A**

- AC power**
  - AC power supply module 130
  - connection 40
  - functional earth ground 39
  - protective earth 39
- accessories**
  - adapter plates 24
  - antiglare overlays 22
  - backlights 22
  - battery 24
  - bezel replacements 24
  - communication modules 21
  - logic modules 21
  - mounting hardware 24
  - power supply and terminal blocks 24
  - SD cards 22
  - solar visor 22
- ActiveX controls** 10, 76
  - Program Launcher 168
- adapter plates** 24
- advanced diagnostics** 99
- alarm display, enable or disable** 76
- antiglare overlays** 22, 177
- application**
  - checking integrity 72
  - loading .MER 48
  - running 48
  - troubleshooting 168

**B**

- back up terminal image** 88
- backlight** 22
  - brightness 65, 94
- backlight control** 65
- backup and restore** 88
- battery** 24
  - replacement 128
  - warning on startup 97
- battery voltage** 74
  - control panel 92
  - FactoryTalk View ME 74
- bezel replacement** 24, 122
- button styles** 98

**C**

- cables** 151
- card slot** 12, 13, 16
- catalog numbers**
  - 400 and 600 terminals 18
  - 700 to 1500 terminals 19
  - accessories 20
  - communication modules 21
  - display modules 20
  - logic modules 21
- clean display** 134
- closed system** 10, 98

**communication**

- controller address 58
  - ControlNet 148
  - DH+/DH485 module 145
  - DH485 146
  - DHPlus 147
  - Ethernet 58, 140
  - KEPServer 56, 110
  - RSLink Enterprise 56
  - serial 142
  - communication module** 15, 21
    - installation 118
    - replacement 119
  - configuration mode**
    - accessing 43
    - loading application 48
    - running application 48
    - terminal settings 46
  - configured terminals** 16
    - 400 and 600 terminals 18
    - 400 and 600 with extended features 18
    - 700 to 1500 terminals 19
    - 700 to 1500 with extended features 19
  - control panel** 87
    - advanced diagnostics 99
    - backup and restore 88
    - battery voltage 92
    - battery warning 97
    - cursor 95
    - desktop background 94
    - display temperature 92
    - input panel 86
    - keyboard and keypad settings 93
    - logo updates 96
    - network servers 101
    - processor temperature 92
    - running processes 91
    - screen saver 95
    - startup options 97
    - system event log 91
    - touch screen calibration 93
    - user accounts 100
  - ControlNet**
    - cables 150
    - compatible controllers 148
    - ControlNet protocol 148
    - overview 148
    - Software Requirements 149
  - copying files**
    - applications 64
    - font files 64
  - cursor**
    - control panel 95
    - FactoryTalk View ME 66
- D**
- date and time** 77
  - DC power**
    - connection 38
    - earth ground 37
    - external power supply 37

**default switch** 171**deleting files**

- applications 62
- font files 62
- log files 62

**desktop access**

- disable 53
- enable 52
- factory default state 11
- open versus closed 10
- reset password 54
- set password 54

**device name** 61**DH485**

- network connections 145
- port connectors 145
- status indicators 145

**DHPlus**

- network connections 147
- port connectors 145
- status indicators 145

**diagnostics**

- in FactoryTalk View ME 73

**dimensions**

- panel cutout 28
- product 29

**display brightness**

- control panel 94
- FactoryTalk View ME 65

**display module** 15, 17, 20, 134**display settings**

- configuration mode 65
- control panel 94
- FactoryTalk View ME 65
- resolution 170

**display temperature**

- control panel 92
- FactoryTalk View ME 65

**E****earth ground**

- DC power 37

**enable desktop access** 52**environment and enclosure information** 25**error messages** 164**Ethernet**

- connector pinout 140
- DHCP 59
- IP address 58
- link speed 60
- name server addresses 60
- port 16
- status indicators 140
- troubleshooting 167

**extended features** 10, 85**external power supply** 37**F****factory defaults** 170**FactoryTalk View Machine Edition Station** 11**FactoryTalk View ME** 56, 74, 76

- alarm display enable or disable 76
- battery voltage 75
- check file integrity 72
- configuration mode 43
- cursor 66
- desktop access 52
- diagnostics 72
- display settings 65
- display temperature 65
- Ethernet settings 58
- font linking 82
- input devices 67
- IP address 58
- keyboard or keypad settings 67
- loading application 48
- print options 70
- processor temperature 75
- regional settings 79-81
- running application 48
- screen saver 66
- startup options 49
- string entry 67
- system event log 74
- system information 76
- terminal device name 61
- terminal settings 46
- time and date operations 76
- touch screen calibration 68
- transferring files 62

**FactoryTalk View Studio for ME** 11**FactoryTalk ViewPoint** 11**file server** 85

- configuration 110

**file viewers** 85**firmware revisions** 76

- control panel 97
- FactoryTalk View ME 76

**firmware upgrades**

- firmware upgrade wizard 154
- over network 158
- recover from failure 165, 172
- using storage device 155

**fonts** 175

- linking 82

**ftp server** 10, 85

- anonymous login example 108
- configuration 107
- connection requiring authentication 109
- security 107

**H****hazardous location** 26**high-bright displays**

- antiglare overlay 177
- installation 177
- solar visor 177

**I****IGMP Protocol** 141

**input devices**

- control panel 93
- FactoryTalk View ME 67
- mouse 67, 69

**input panel 45****installation**

- backlight 124
- battery 128
- bezel 122
- environment and enclosure 25
- hazardous location 26
- high-bright displays 177
- keypad legend inserts 132
- mounting 700 to 1500 terminals terminal 33
- panel cutouts 28
- product dimensions 29
- product label 132
- USB peripheral devices 27, 138

**Internet Group Management Protocol (IGMP)**

- 141

**K****KEP Server configuration 110****keyboard and keypad settings**

- control panel 93
- FactoryTalk View ME 67
- troubleshooting 167

**keypad input 17****L****languages 79****loading application 48****logic module 15, 16, 21**

- replacement 118

**logo manager 96****logs**

- application files 72
- runtime files 72
- system event log 74, 91, 163

**M****maintenance operations**

- accessing 171
- default switch 171
- factory defaults 170
- resolution 170
- safe mode 170

**marine-certified components 17, 21****memory usage 74**

- control panel 92
- FactoryTalk View ME 74

**Microsoft Office viewers**

- Excel 10, 85
- PowerPoint 10, 85
- Word 10, 85

**mounting 33**

- hardware 24

**mouse 67, 69**

- troubleshooting 166

**N****network servers 85, 101**

- enabling or disabling 101
- file 110
- ftp 107
- vnc 102
- web 106

**O****open system 10, 98****open versus closed system 10, 98****operating system 10, 83**

- application support 84
- extended features 10
- network support 84
- scripting support 84
- server support 85
- without extended features 10

**P****panel cutout dimensions 28****password**

- desktop access 54
- reset password 54
- set password 54

**PDF reader 10, 85, 114****power connections**

- AC power 39
- AC power supply module 130
- DC power 36
- restart 42
- terminal block 35

**power supply and terminal blocks 24, 35****print setup**

- for alarms 70
- for diagnostic messages 70
- for displays 70

**processor temperature 74**

- control panel 92
- FactoryTalk View ME 74

**product dimensions 29****Program Launcher ActiveX Control 168****protective earth**

- AC power 39

**R****regional settings**

- FactoryTalk View ME 79-81

**reset terminal 170**

- from maintenance window 170
- reset switch 16, 41

**restart system 41****restore factory defaults 170, 172****restore terminal image 88**

**right-click functionality on touch screen** 84  
**RSLinux communication settings** 56  
**run loaded application** 48  
**runtime cables** 151

## S

**safe mode** 98, 170  
**screen saver**  
 control panel 95  
 FactoryTalk View ME 66  
**SD card** 22  
 loading 134  
 slot 134  
 using to back up and restore image 88  
**serial communication**  
 connections 142  
 DF1 142  
 DH485 142  
 null modem cable 143  
 ports 142  
 transferring applications 142  
 using a modem 143  
**servers**  
 enabling or disabling 101  
 file 85, 110  
 ftp 85, 107  
 UPnP 85  
 ViewPoint 85  
 VNC 85, 101, 102  
 web 85, 106  
**Simple Network Management Protocol (SNMP)** 141  
**software support**  
 FactoryTalk View ME Station 11  
 FactoryTalk View Studio for ME software 11  
 FactoryTalk ViewPoint software 11  
 Windows CE operating system 11  
**solar visor** 22  
**startup**  
 anomalies 168  
 error messages 163, 164  
 initial 41  
**startup options** 11, 42  
 advanced diagnostics 99  
 changing button style 98  
 control panel 97  
 detecting safe mode 98  
 disable configuration mode 49  
 disable FactoryTalk View ME Station 49  
 displaying battery warning 97  
 displaying watchdog errors 99  
 FactoryTalk View ME 49  
 open or closed system 98  
 run configuration mode 49, 50  
 run loaded application 51  
**status indicators** 16, 140  
**string entry** 67  
**system event log** 163  
 control panel 91  
 FactoryTalk View ME 74

**system information**  
 control panel 97  
 FactoryTalk View ME 76

## T

**temperature**  
 display 92, 163  
 logic module 92  
 processor 74, 163  
**terminal features**  
 400 12  
 600 13  
 700 to 1500 15  
**terminal settings** 46  
 date 77  
 diagnostics 73  
 short date format 81  
 system event log 74  
 time 77  
 time format 80  
 time zone 78  
**time and date operations**  
 FactoryTalk View ME 76  
**touch screen** 14, 17  
**touch screen calibration**  
 control panel 93  
 FactoryTalk View ME 68  
**transferring files** 64  
**troubleshooting** 161  
 accessing configuration mode 168  
 advanced 169  
 change display resolution 170  
 Ethernet connection 167  
 general 162  
 keyboard 167  
 maintenance operations 170  
 mouse 166  
 power check 162  
 restore factory defaults 170  
 start in safe mode 170  
 start-up error messages 164

## U

**UPnP server** 85  
**USB flash drive**  
 using to back up and restore image 89  
**USB ports**  
 connector pinouts 138  
 device port 12, 13, 16, 138  
 host ports 12, 13, 16, 27, 138  
 installation 27  
**user accounts** 100

**V****VNC server** 85

- client viewers 84, 102
- configuration 102
- control and view connection example 104
- control operations 102
- security 102
- view-only connection example 103
- view-only operations 102

**voltage**

- battery 92, 163

**W****watchdog errors** 99**web browser** 10**web server** 85

- configuration 106

**Windows CE operating system** 11, 83

- with extended features 10
- without extended features 10

**Windows Explorer** 86**wiring and safety guidelines** 137







## Rockwell Automation Support

Use the following resources to access support information.

<b>Technical Support Center</b>	Knowledgebase Articles, How-to Videos, FAQs, Chat, User Forums, and Product Notification Updates.	<a href="https://rockwellautomation.custhelp.com/">https://rockwellautomation.custhelp.com/</a>
<b>Local Technical Support Phone Numbers</b>	Locate the phone number for your country.	<a href="http://www.rockwellautomation.com/global/support/get-support-now.page">http://www.rockwellautomation.com/global/support/get-support-now.page</a>
<b>Direct Dial Codes</b>	Find the Direct Dial Code for your product. Use the code to route your call directly to a technical support engineer.	<a href="http://www.rockwellautomation.com/global/support/direct-dial.page">http://www.rockwellautomation.com/global/support/direct-dial.page</a>
<b>Literature Library</b>	Installation Instructions, Manuals, Brochures, and Technical Data.	<a href="http://www.rockwellautomation.com/global/literature-library/overview.page">http://www.rockwellautomation.com/global/literature-library/overview.page</a>
<b>Product Compatibility and Download Center (PCDC)</b>	Get help determining how products interact, check features and capabilities, and find associated firmware.	<a href="http://www.rockwellautomation.com/global/support/pcdc.page">http://www.rockwellautomation.com/global/support/pcdc.page</a>

## Documentation Feedback

Your comments will help us serve your documentation needs better. If you have any suggestions on how to improve this document, complete the How Are We Doing? form at [http://literature.rockwellautomation.com/idc/groups/literature/documents/du/ra-du002\\_-en-e.pdf](http://literature.rockwellautomation.com/idc/groups/literature/documents/du/ra-du002_-en-e.pdf).

Rockwell Automation maintains current product environmental information on its website at <http://www.rockwellautomation.com/rockwellautomation/about-us/sustainability-ethics/product-environmental-compliance.page>.

Allen-Bradley, CompactLogix, ControlLogix, DH+, Encompass, FactoryTalk, MicroLogix, PLC-5, PanelView, RSLinx, RSNetwork, RSView, Rockwell Automation, Rockwell Software, SLC, and Studio 5000 are trademarks of Rockwell Automation, Inc.

EtherNet/IP is a trademark of ODVA, Inc.

SD and SDHC are trademarks of SD-3C LLC.

Trademarks not belonging to Rockwell Automation are property of their respective companies.

Rockwell Otomasyon Ticaret A.Ş., Kar Plaza İş Merkezi E Blok Kat:6 34752 İçerenköy, İstanbul, Tel: +90 (216) 5698400

**[www.rockwellautomation.com](http://www.rockwellautomation.com)**

### Power, Control and Information Solutions Headquarters

Americas: Rockwell Automation, 1201 South Second Street, Milwaukee, WI 53204-2496 USA, Tel: (1) 414.382.2000, Fax: (1) 414.382.4444

Europe/Middle East/Africa: Rockwell Automation NV, Pegasus Park, De Kleetlaan 12a, 1831 Diegem, Belgium, Tel: (32) 2 663 0600, Fax: (32) 2 663 0640

Asia Pacific: Rockwell Automation, Level 14, Core F, Cyberport 3, 100 Cyberport Road, Hong Kong, Tel: (852) 2887 4788, Fax: (852) 2508 1846

Publication 2711P-UM006I-EN-P - February 2020

Supersedes Publication 2711P-UM006H-EN-P - May 2019

Copyright © 2020 Rockwell Automation, Inc. All rights reserved. Printed in the U.S.A.