

Programmable Operator Interface

# MONITOUCH

**V9** series  
V9 makes automation complete.



# Satisfying, intuitive control Impressive ability to convey data. Boosts efficiency in the field through enhanced performance.

On its release in 1988 as the first ever programmable display\*, MONITOUCH ushered in a new era of human-machine interface technology. It is now used as an information terminal for countless different purposes in production sites all over the world. The total number of shipments has reached around one million.

We have continuously pioneered the field of programmable displays through an impressive array of exciting new cutting-edge features specifically designed to meet the needs of our clients.

**MONITOUCH THE PREMIUM.**

We are confident that this lineup will meet your requirements for all types of application.

\*According to our own research.



V9 Standard  
High performance model



V9 Advanced  
High resolution widescreen LCD with wireless LAN



V9 Lite  
Basic model

# MONITOUCH V9 series

|                              |                                   |  |
|------------------------------|-----------------------------------|--|
| 04..... Lineup V9            | 19..... Optional Accessories      | 29..... Lineup V808CH  |
| 06..... Network              | 20..... Specifications            | 30..... PLC Connection - Summary                                       |
| 10..... Usability & Graphics | 22..... System Configuration      | 32..... Temperature Controller / Servo / Inverter Connection - Summary |
| 12..... Storage              | 24..... Dimensions & Part Names   | 34..... Service & Support  |
| 14..... Security             | 26..... Product Details           | 35..... Product Warranty   |
| 15..... Information          | 27..... Optional Accessories List |  |
| 16..... V-SFT Ver.6          | 28..... Lineup TS2000             |  |

# Meeting customer needs with a product lineup suited to all kinds of applications.

## V9 Advanced

10.1 inches

- V9101iWRLD **DC**
- V9101iWLD **DC**



7 inches

- V9071iWRLD **DC**
- V9071iWLD **DC**



## V9 Standard

15 inches

- V9150iX **AC**
- V9150iXD **DC**



12.1 inches

- V9120iS **AC**
- V9120iSB **AC** **BLACK**
- V9120iSD **DC**
- V9120iSBD **DC** **BLACK**



## V9 Lite

10.4 inches

- V9100iS **AC**
- V9100iSB **AC** **BLACK**
- V9100iSD **DC**
- V9100iSBD **DC** **BLACK**



8.4 inches

- V9080iSD **DC**
- V9080iSBD **DC** **BLACK**



10.4 inches

- V9100iC **AC**
- V9100iCB **AC** **BLACK**
- V9100iCD **DC**
- V9100iCBD **DC** **BLACK**



8.4 inches

- V9080iCD **DC**
- V9080iCBD **DC** **BLACK**



5.7 inches

- V9060iTD **DC**
- V9060iTBD **DC** **BLACK**



| Model                       | V9101iW                    | V9071iW                       | V9150iX                    | V9120iS                    |
|-----------------------------|----------------------------|-------------------------------|----------------------------|----------------------------|
| Display Size                | 10.1" widescreen           | 7" widescreen                 | 15"                        | 12.1"                      |
| Display Device              | TFT color                  | TFT color                     | TFT color                  | TFT color                  |
| Resolution W:H (dots)       | 1024x600                   | 800x480                       | 1024x768                   | 800x600                    |
| Display Colors              | 16.7 million <sup>*1</sup> | 16.7 million <sup>*1</sup>    | 16.7 million <sup>*1</sup> | 16.7 million <sup>*1</sup> |
| Touch Switch                | Capacitance                | Capacitance                   | Analog resistance film     | Analog resistance film     |
| Screen Memory (FROM)        | 64MB                       | 64MB                          | 64MB                       | 64MB                       |
| Backup Memory (SRAM)        | 800KB                      | 800KB                         | 800KB                      | 800KB                      |
| Ethernet(LAN)               | ✓                          | ✓                             | ✓                          | ✓                          |
| Extended Cable LAN          | ✓                          | ✓                             | △ <sup>*2</sup>            | △ <sup>*2</sup>            |
| Wireless LAN                | △ <sup>*2</sup>            | △ <sup>*2</sup>               | △ <sup>*2</sup>            | △ <sup>*2</sup>            |
| Serial (CN1)                | RS-232C/422/485            | RS-232C/422/485 <sup>*3</sup> | RS-232C/422/485            | RS-232C/422/485            |
| Serial (MJ1)                | RS-232C/485                | RS-232C/485                   | RS-232C/485                | RS-232C/485                |
| Serial (MJ2)                | RS-232C/485                | RS-232C/422/485               | RS-232C/485                | RS-232C/485                |
| Communication I/F (CUR-XX)  | ✓                          | ✓                             | ✓                          | ✓                          |
| Expansion Unit I/F (GUR-XX) | ✓                          | —                             | ✓                          | ✓                          |
| SD Card I/F                 | ✓                          | ✓                             | ✓                          | ✓                          |
| USB (Type A)                | ✓                          | ✓                             | ✓                          | ✓                          |
| USB (Type mini-B)           | ✓                          | ✓                             | ✓                          | ✓                          |
| Sound Output                | ✓                          | —                             | ✓                          | ✓                          |

Please refer to page 26 for the details of each model.

| V9100iS                    | V9080iSD                   | V9100iC                    | V9080iCD                   | V9060iTD                      |
|----------------------------|----------------------------|----------------------------|----------------------------|-------------------------------|
| 10.4"                      | 8.4"                       | 10.4"                      | 8.4"                       | 5.7"                          |
| TFT color                  | TFT color                  | TFT color                  | TFT color                  | TFT color                     |
| 800x600                    | 800x600                    | 640x480                    | 640x480                    | 640x480                       |
| 16.7 million <sup>*1</sup> | 16.7 million <sup>*1</sup> | 16.7 million <sup>*1</sup> | 16.7 million <sup>*1</sup> | 260 thousand <sup>*1</sup>    |
| Analog resistance film     | Analog resistance film     | Analog resistance film     | Analog resistance film     | Analog resistance film        |
| 64MB                       | 64MB                       | 64MB                       | 64MB                       | 64MB                          |
| 800KB                      | 800KB                      | 800KB                      | 800KB                      | 800KB                         |
| ✓                          | ✓                          | ✓                          | ✓                          | ✓                             |
| △ <sup>*2</sup>            | △ <sup>*2</sup>            | —                          | —                          | —                             |
| △ <sup>*2</sup>            | △ <sup>*2</sup>            | —                          | —                          | —                             |
| RS-232C/422/485            | RS-232C/422/485            | RS-232C/422/485            | RS-232C/422/485            | RS-232C/422/485 <sup>*3</sup> |
| RS-232C/485                | RS-232C/485                | RS-232C/485                | RS-232C/485                | RS-232C/485                   |
| RS-232C/485                | RS-232C/485                | RS-232C/485                | RS-232C/485                | RS-232C/422/485               |
| ✓                          | ✓                          | ✓                          | ✓                          | ✓                             |
| ✓                          | ✓                          | —                          | —                          | —                             |
| ✓                          | ✓                          | ✓                          | ✓                          | ✓                             |
| ✓                          | ✓                          | ✓                          | ✓                          | ✓                             |
| ✓                          | ✓                          | —                          | —                          | —                             |

\*1 For pictures, 3D parts, video and RGB input (excluding high-speed mode) only. Other items are displayed in 65,536 colors. \*2 Depending on the model. \*3 When optional unit DUR-00 is installed.



# Network

Enhanced safety features while connecting to various types of network

## VNC Server

### Remote Connection from Tablet PCs

All of the V9 family has remote monitoring/maintenance capabilities via Ethernet, thanks to its VNC feature.



\*1 Wireless LAN compatible products only

Tablet PC

### VNC App: Simple Remote

By installing Simple Remote on your Android device, you can get connected remotely right away. The app is available for free on Google Play.<sup>\*2</sup>



\*2 Android, Google Play and the Google Play logo are trademarks of Google LLC.

### Selecting Priority for VNC Connections

When using a single MONITOUCH unit to remotely monitor and control more than one client device, you can choose the priority as either priority-first or priority-last. If you have a priority-first connection, the client will not change suddenly.

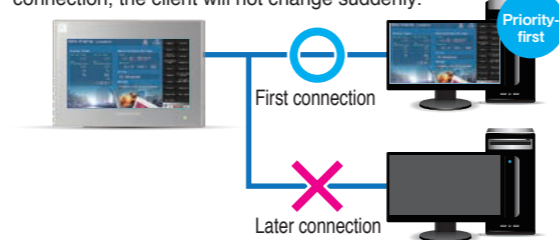

### Authentication by MAC Address for VNC Connections

For PC client connection authentications, it is possible to prevent connections from unspecified devices by supplementing usernames and passwords with MAC addresses. This enhances security.

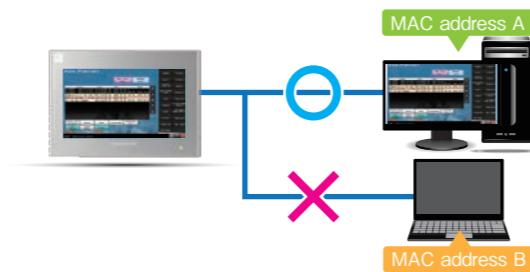

## DHCP Server<sup>\*3</sup> / DHCP Client

### Easy Communication with DHCP

The information required for network connectivity can be acquired from a server as a DHCP client or can assign to a client as a DHCP server.



\*3 The DHCP server is only available for wireless LAN-compatible products.

## Web Machine Interface

### VPN Remote Access / Cloud Data Utilization Solution

The Web Machine Interface is a solution service that makes remote monitoring safe, easy, and inexpensive. It consists of two services: "VPN Remote Access Service" which enables secure remote monitoring by VPN and "Cloud Data Utilization Service" which can receive various types of data via a cloud server. By performing remote maintenance, it is possible to check for signs of abnormality in advance and ensure proper maintenance of the machine. It also helps to reduce the number of sudden stoppages and implements preventive maintenance.

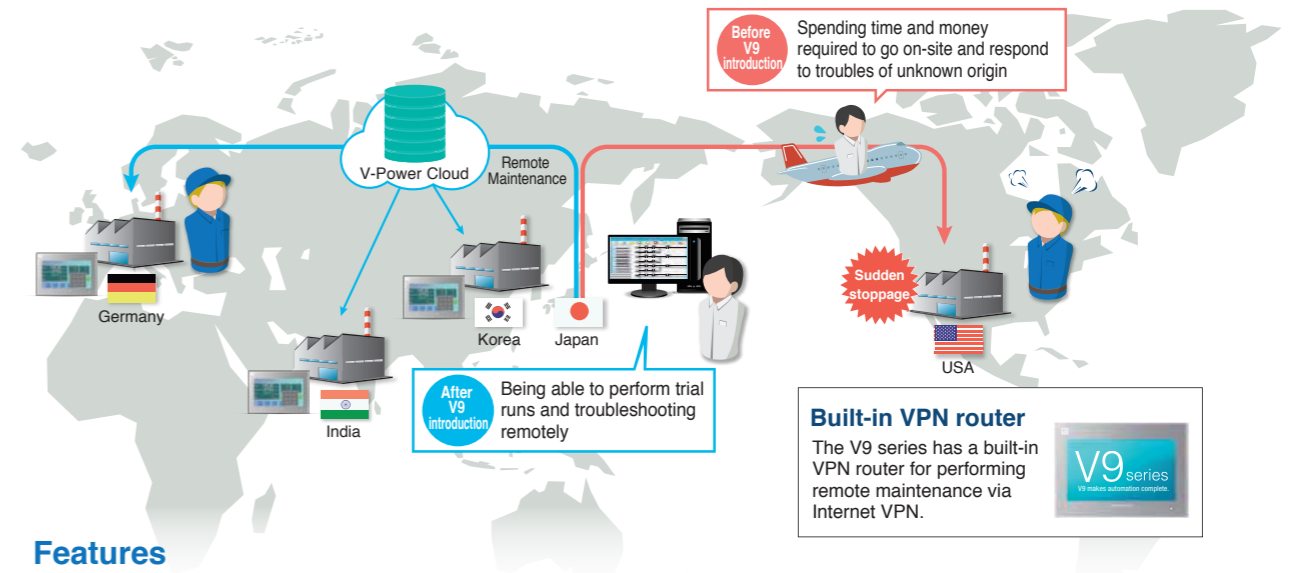

### Features

**\$** Creates remote connectivity inexpensively

If you have an Internet connection, you can build a VPN environment only by the V9 series without using a VPN router.

**🔒** Provides highly secure remote access

SSL-VPN enables you to securely connect to remote locations without worrying about eavesdropping or tampering.

**🔄** Makes it easy to access peripheral devices remotely

The built-in routing function allows easy remote access to PLC and various devices connected to the V9 series by Ethernet.

## Network Camera Compatible

### Real-time Monitoring of Remote Site

By connecting to a network camera, it is possible to display camera images in real time on the V9 series screen. It is especially useful for monitoring and checking the inside of clean rooms.

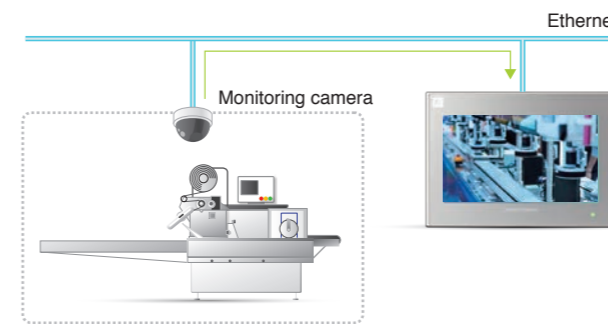

## FTP Compatible

### Easily Retrieve Files in Storage from Remote Locations

**FTP Server Function**  
Files in a storage media inserted in a V9 can be read out and written using a PC.

**FTP Client Function**  
Files on an FTP server can be read and written using the V9 series.

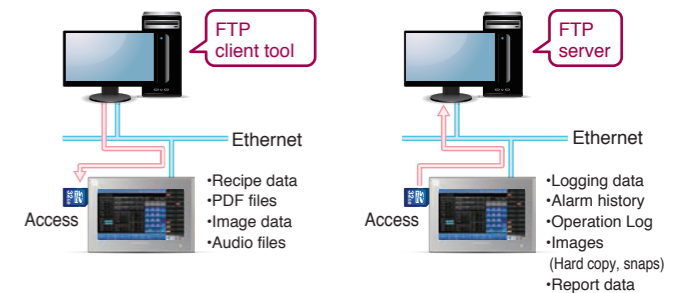

## Remote Desktop

### Control the PC Screen from the V9 series

By connecting to Ethernet, you can display the screen of the PC directly on the V9 series. You can view work instructions and manuals located on PCs even at manufacturing sites that do not allow you to carry in PCs. It improves the efficiency of maintenance.

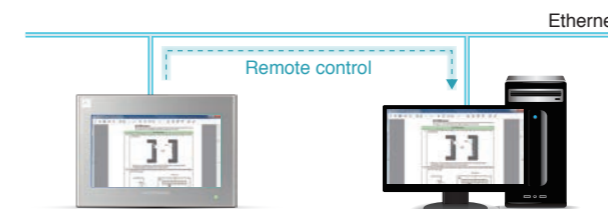

## Network Printer Compatible<sup>\*4</sup>

### Share Printers with Multiple V9 series

Printing jobs from multiple V9 series can be shared via a single network printer. Network printer connection supports both wired and wireless LAN, and that helps to achieve space and cable savings.

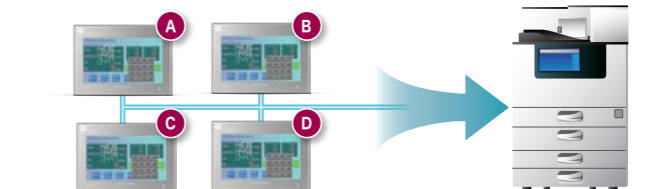

\*4 Compatible only with EPSON ESC/P-R. Wireless LAN connection is possible for wireless LAN compatible products.

## 8-Way Communication

### Connection and Data Transmission with Multiple Devices

You can connect up to eight different models, off-brand PLC and other peripheral devices at the same time via both Ethernet and serial connection.

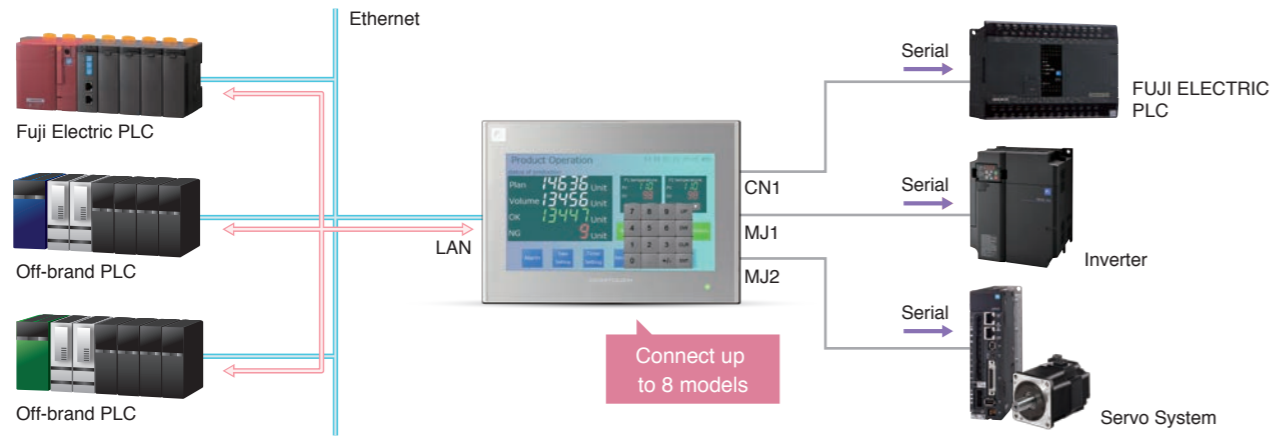

## Supports EtherCAT<sup>1</sup> Connection

### EtherCAT (Slave) Connection

The "CUR-09" communication unit for EtherCAT connection allows for general connection to EtherCAT compatible models. It can also serve as a gateway between devices connected to the V9 series and the EtherCAT master equipment.

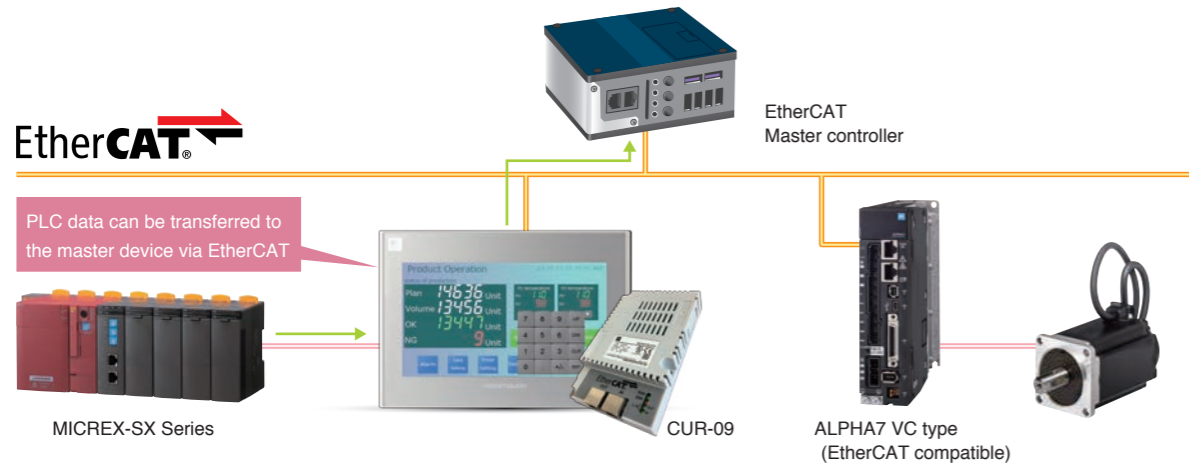

<sup>1</sup> EtherCAT® is a patented technology and registered trademark licensed by Beckhoff Automation GmbH (Germany).

## Ladder Monitoring Function

### Enable PLC Monitoring

PLC ladder monitoring is available on the V9 series screen. It is possible to search for the target address freely or to switch programs during RUN mode in case there are multiple programs.

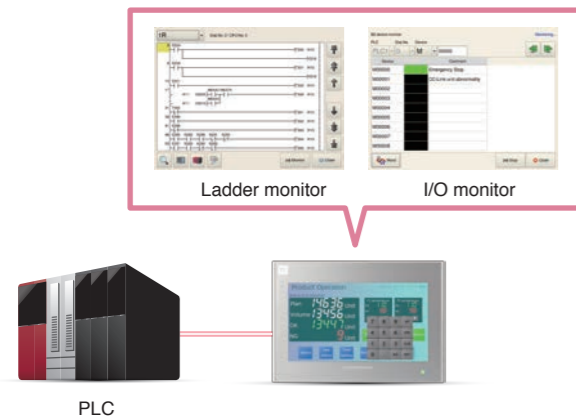

## Path-through Programming

### Ladder Program Transmission (3-way)

Up to 3 PLCs are accessible to monitor and revise PLC programs by connecting a PC to the V9 via Ethernet.

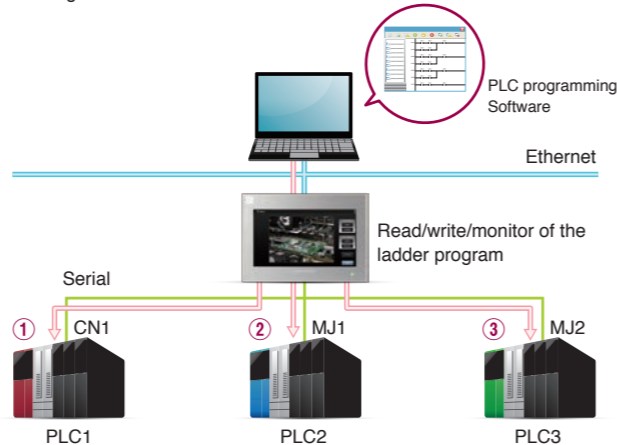

## TELLUS and V-Server

### Remote Monitoring and Operation Solutions

This application software connects remotely located V9 series to office computers in order to provide on-site information and to monitor and control equipments. You can allocate jobs based on the operation conditions of the line, respond quickly to trouble, and achieve more efficient and cost-effective production.

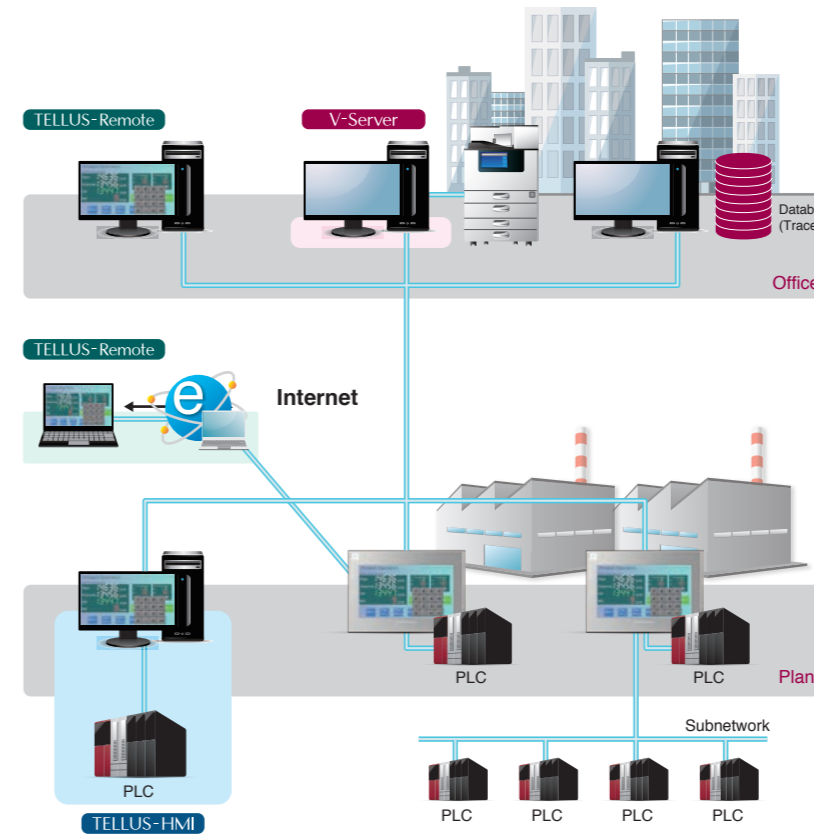

### V-Server

#### Real-time collection of on-site information

- Data can be collected in real time by capturing site status and production information.
- It can be linked with databases such as SQL Server. Or save data in CSV or Excel format.
- It supports operations suited to the site via various operation directives based on event monitoring.

### TELLUS-Remote

#### Easy, low-cost monitoring and operation from remote locations

- You can use the same screen data as the on-site V9 series, eliminating the need to create a new remote monitoring screen.
- Multiple startups allow you to monitor and operate more than one V9 series via a single PC.

### TELLUS-HMI

#### Use V9 series features directly on your PC

- Display and operation can be performed on your PC instead of on the V9 series.
- It enables you to easily connect to peripheral devices such as printers. There is no need to worry about selecting peripheral devices.

## MES<sup>2</sup> Interface Features

### Operation Monitoring and Production Management Solutions

Various types of information such as aggregation of production results, number of defects and stoppage factors are sent to the database using SQL statements from the V9 series through the V-Server. Communication with the database can be accomplished without a gateway PC or cumbersome programming.

#### Programming not required

By simply specifying the data to be stored in the database on V-SFT, you can communicate with the database without the need for programming.

#### Prevents data loss

If transmission fails, it will produce an error log, so you do not have to worry about losing important data.

#### Reduces system load

When various conditions are fulfilled, data can be transmitted from the V9 series. It reduces the load on the system by eliminating the need for constant monitoring on the higher-level side.

<sup>2</sup>MES: Manufacturing Execution System

This "Manufacturing Execution System" has been designed to optimize quality, production volume, delivery time, and cost as a management and production control system for manufacturing sites.

### V-Server

The V-Server collects data and gives instructions to the production site over LAN. You can manage multiple V9 series with a single license without adding optional equipment to the V9 itself.

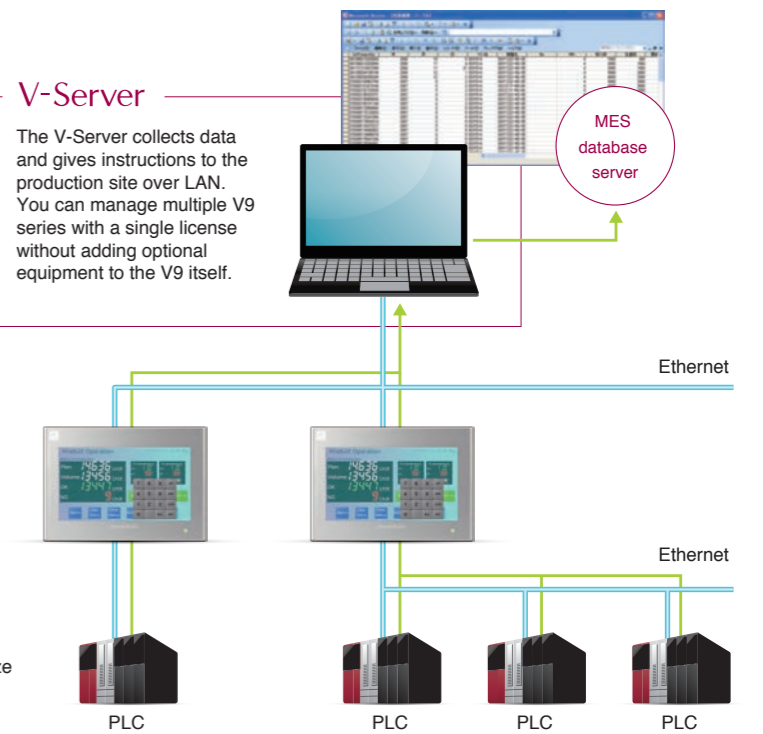



# Usability & Graphics

Render overwhelming beauty and outstanding visibility to the finest detail



## Smooth Operation with Your Fingers

### Zooming In and Out with Two Fingers

V9 Advanced

The displayed image can be magnified up to 200% by pinching out the screen<sup>1</sup>. It can be reduced to its original size by pinching it in.



Enlarge up to 200%

<sup>1</sup> Images can be scaled up and down by double tapping when using V9 Standard/Lite.

### Scrolling Magnified Images

You can view a particular part of a magnified image in close-up while scrolling around the screen.



## Abundant Quantity of Information

### Displaying Four Times the Screen Size

First in industry

The whole area of a large image can be confirmed easily by scrolling the screen without the need of switching it. The navigation window helps you to recognize the current displayed position instantly.

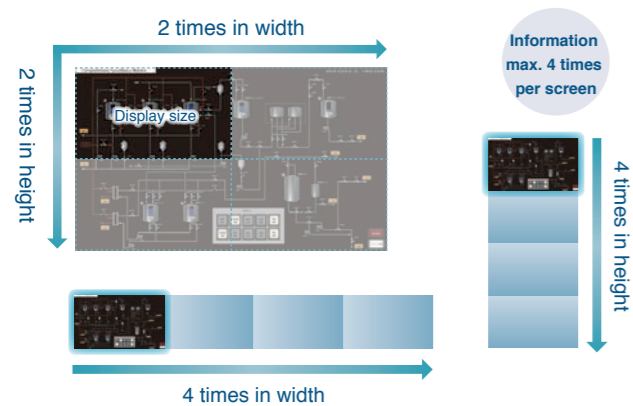

Images can be laid out four times the screen size in height or width according to your needs.

<sup>2</sup> According to our own research.

### Widescreen LCD

V9 Advanced

V9 Advanced models are equipped with a high-precision, high-resolution widescreen (16:9). Greater volume and variety of information can be displayed on the screen.

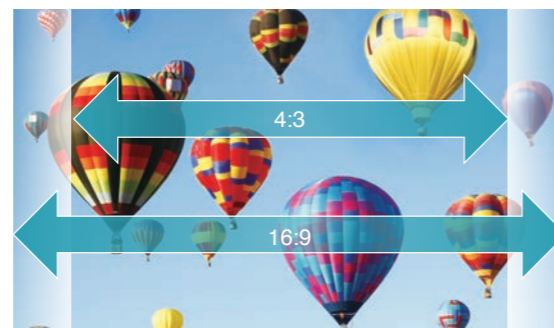

## Expression and Beauty

### 7-segment Fonts for Realistic Expression

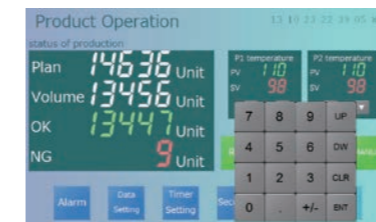

7-segment fonts allow for realistic, highly visible expression of measuring instruments. Non-illuminated segments can be shown in a subtle color.

### TrueType Font as Standard

TrueType font has been added to the standard fonts. Smoother display is possible via antialiasing. Furthermore, space can be reduced relative to Windows fonts, thus enabling you to work without worrying about screen data memory.



### Audio Playback Function<sup>4</sup>

It comes standard with an output port for audio playback that allows you to play audio files saved to storage without any optional units.

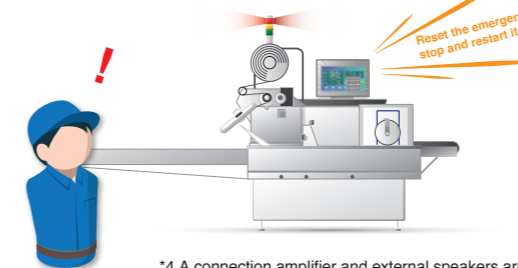

<sup>4</sup> A connection amplifier and external speakers are required.  
<sup>5</sup> V9101W/V9 Standard only

### Extended Datasheets

It also supports PDF output in addition to standard printer output. By converting various forms such as daily reports to PDF, the printer is no longer needed. It helps to achieve paper and space savings. PDF files saved on storage can be transferred to PC in office using FTP server/client functions, which allows you to check data without having to go to the production site.

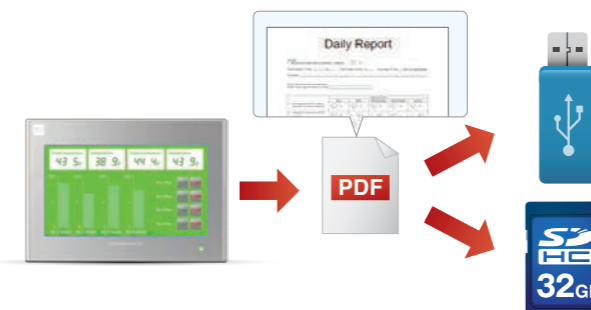

### Compatible with Vertical Placement

The screen can also be displayed and edited while the panel is placed vertically (by left or right turning).



For all models

### Video/RGB Input-Output

By attaching an optional unit, videos and RGB images can be displayed on the V9. Also, images displayed on the V9 can be sent to external displays.

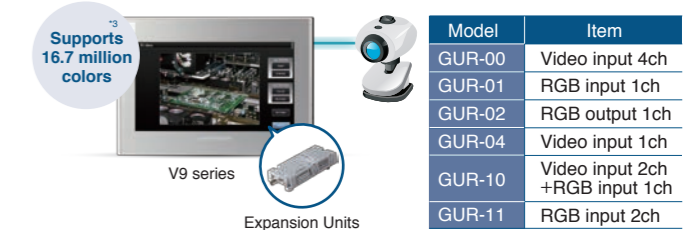

| Model  | Item                            |
|--------|---------------------------------|
| GUR-00 | Video input 4ch                 |
| GUR-01 | RGB input 1ch                   |
| GUR-02 | RGB output 1ch                  |
| GUR-04 | Video input 1ch                 |
| GUR-10 | Video input 2ch + RGB input 1ch |
| GUR-11 | RGB input 2ch                   |

<sup>3</sup> For displaying pictures, 3D parts, video, and RGB input (excluding high-speed mode) only. Other parts are displayed in 65,536 colors.

### Dimmer Function

Fine-grained adjustment is possible via 128-step setting. Even at night or in dark places, the screen is easy to see and not too dazzling, thus enabling smooth operation.

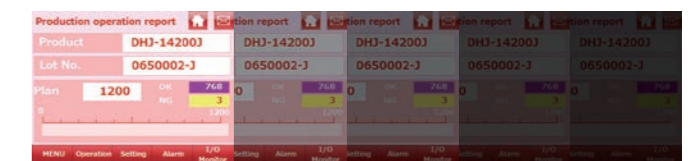

Bright ← → Dark

### Overlap Function

Up to 10 pop-up windows can be displayed on the screen at the same time. All of them can be displayed transparently without limiting the overlap size of each window. You can also use overlap screens as subscreens or check them by scrolling without switching to the main screen.

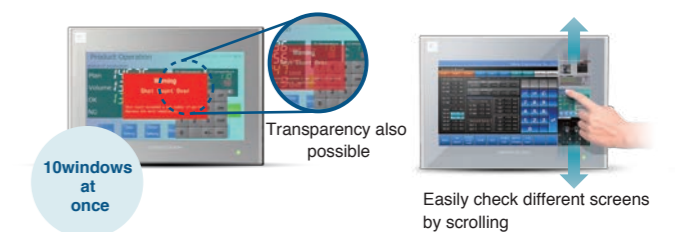

10 windows at once

Transparency also possible

Easily check different screens by scrolling



# Storage

Store and manage data and develop it with scalable functions.

## Compatible with Event Record Functions

### Instantaneous Video Recording and Playback

By using a commercially available USB camera<sup>\*1</sup>, you can record video before and after alarm occurrences, such as those due to momentary stoppages, and save it in an SD card to support cause investigation and improve the operating efficiency of equipment.

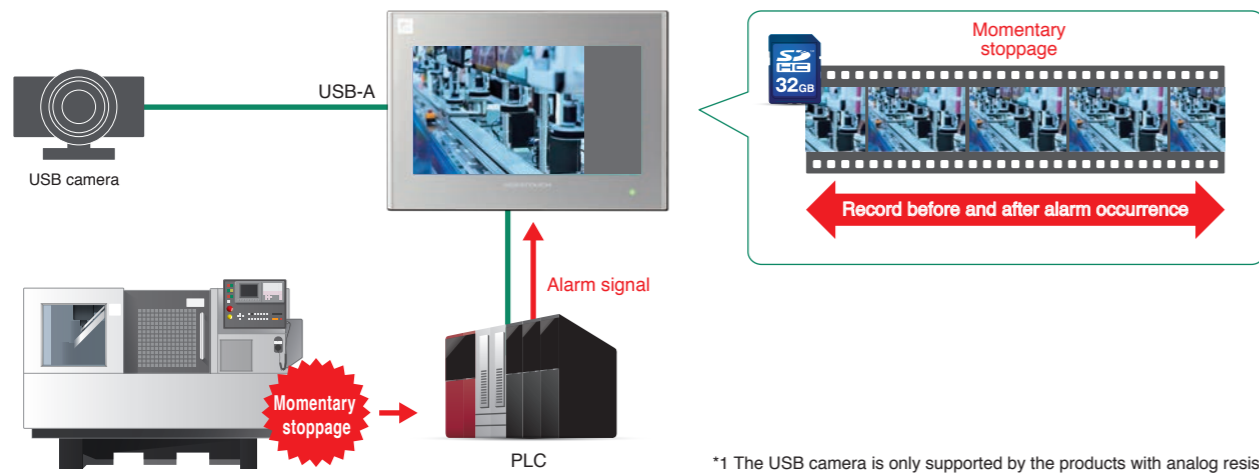

\*1 The USB camera is only supported by the products with analog resistive film.

## Equipped with Video Player

### Play Video Data Saved to Storage

By playing videos used for troubleshooting at time of abnormalities, operators can easily learn how to react to the issues quickly. In addition to viewer initiated playback from the system menu, video can also be played via switch and PLC controller commands. It supports MP4 (MPEG-4) video files to ensure high compression and high quality.

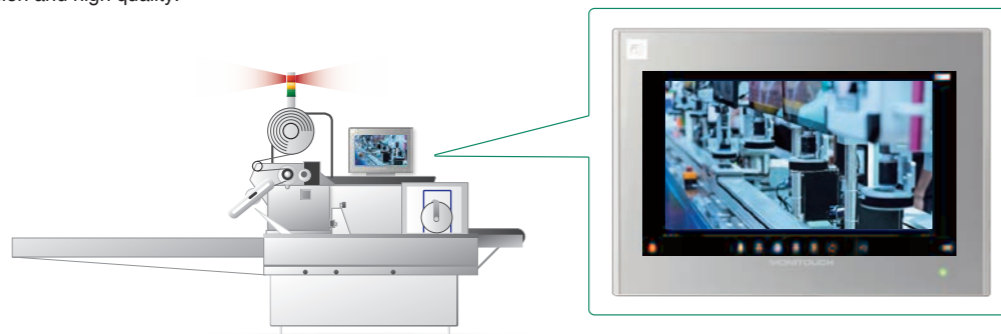

## Trend Data Display

### Backup Data Display

Backup files can be loaded and displayed on the V9. Alarm backup data can also be displayed.



### Easy Creation of Backup Files

By using the scheduler, backup files are automatically created at scheduled timings.

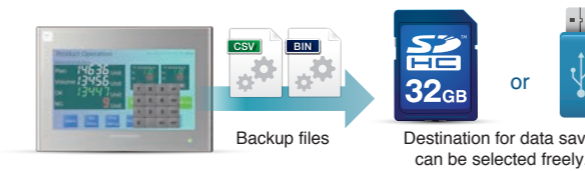

### Coordination with the Scheduler

Operations such as bit output and execution of macro programs can be scheduled on a specific date and time. Also, start and stop of logging, and data saving can be conducted by setting the logging conditions.

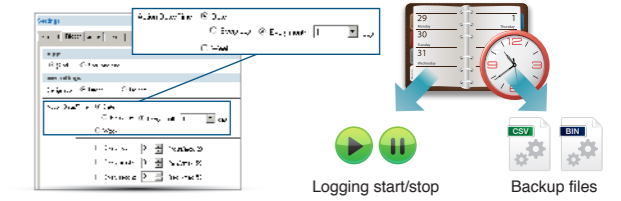

### Zoom In and Out of Graphs

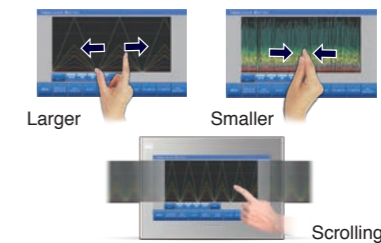

You can zoom in and out on the vertical and horizontal axes of trend graphs. You can also scroll<sup>\*2</sup> by touching and dragging zoomed-in graphs.

\*2 Supports only horizontal scrolling.

## Alarm Display

### Scrolling of the Alarm Messages



Scrolling the alarm messages

The entire alarm message can be displayed by scrolling the screen with touch and drag.

### Running Emergency Messages



Alarm messages run automatically at a specified position when alarms are occurred.

Convenient tools for scrolling

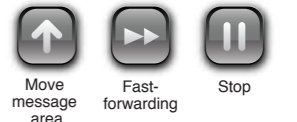

## Recipe

### Global Control Function

It is possible to read and write to specified files and record data, regardless of the screen displayed, by turning on or off a bit.

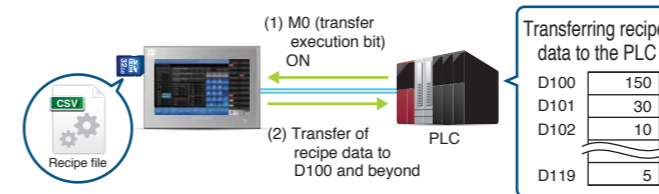

### Filter Settings

The required data can be easily extracted using the recipe selection list dialog to narrow down file and record searches.

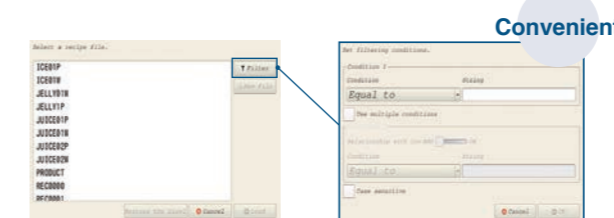

## PDF Viewer Function

### PDF Viewer Function

PDF files stored on an SD card can be displayed. PDF instruction manuals can be used for troubleshooting.

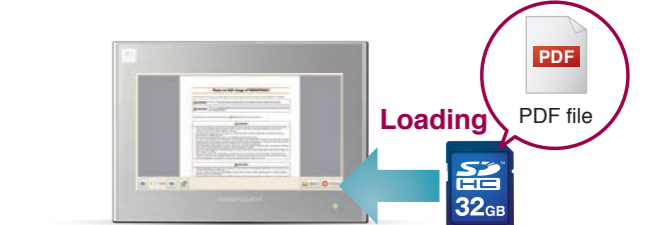

Fast navigation to the desired page, using bookmarks.





# Security

Various setting functions for improving usability



# Information

Visualizing information for prompt recognition



## Operation Log

### Improved Operation Log Viewer

The operability and visibility of the log viewer have been improved.

Operability  
Visibility  
Improvement

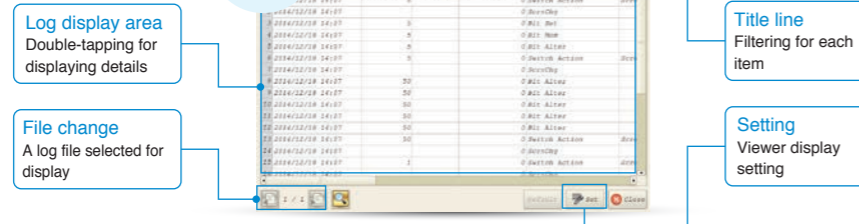

### Search Function

Operation log can be searched for by specifying an operator or date and time.

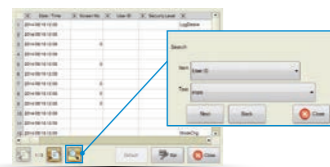

### Filter/Sort Settings

Filter and sort can be set for displayed items.

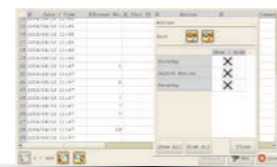

### Display Item Settings

It is possible to select items to display in the operation log.

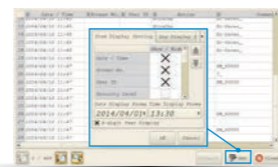

## Security Features

### Security Level Setting

A security level between 0 and 15 can be set for each screen. You can create a high-level security environment by restricting features based on security level.

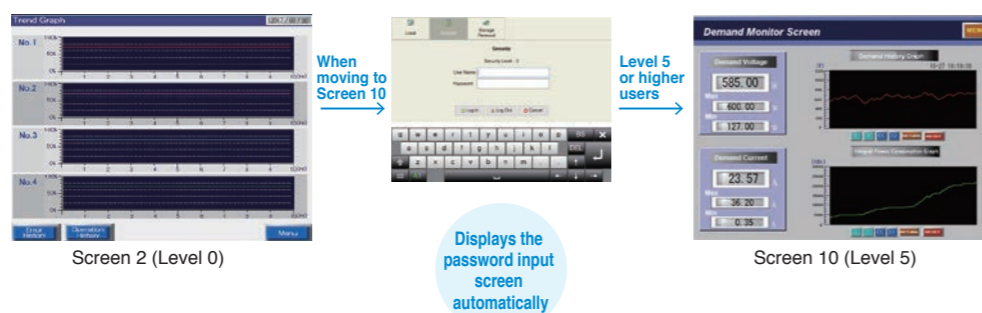

### Switch Interlock

A security level can also be set for a switch. Only users who log in at the authorized level will be able to operate the switch.

## Local Screen Settings

### Transmission Setting

Transmission settings with connected devices can be modified on the V9.

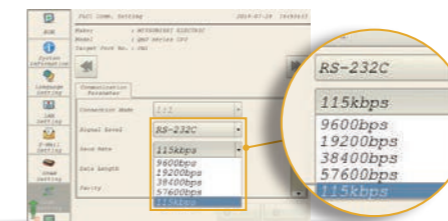

Communication Setting

### Backlight Setting

Backlight settings can be modified on the V9.

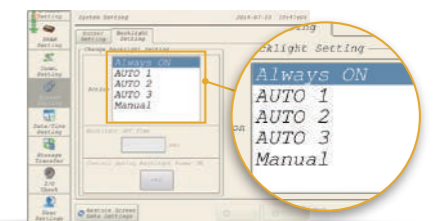

Backlight Setting

### Buzzer Setting

Buzzers settings can be modified on the V9.

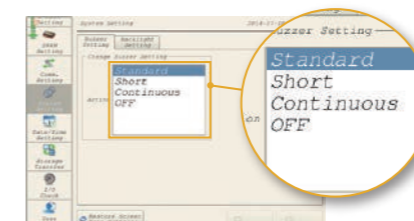

Buzzer Setting

### Network Query

Ethernet network status and IP redundancy within the network can be verified.



Network Test

### E-mail Setting

E-mail addresses and SMTP IP addresses can be modified.

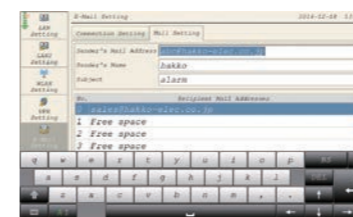

E-mail Setting

### RGB Adjustment

It displays the frequency of the connected device as a real value. Frequencies that cannot be displayed on the screen are displayed in red, so you can check the availability of a connection at a glance.

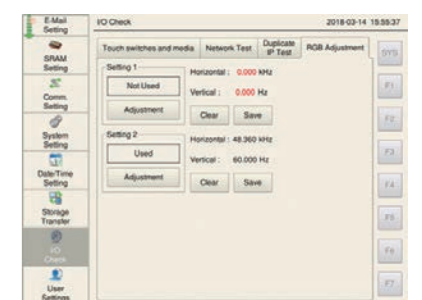

RGB Adjustment



# Achieve sleeker screens with simple, easy-to-understand operations

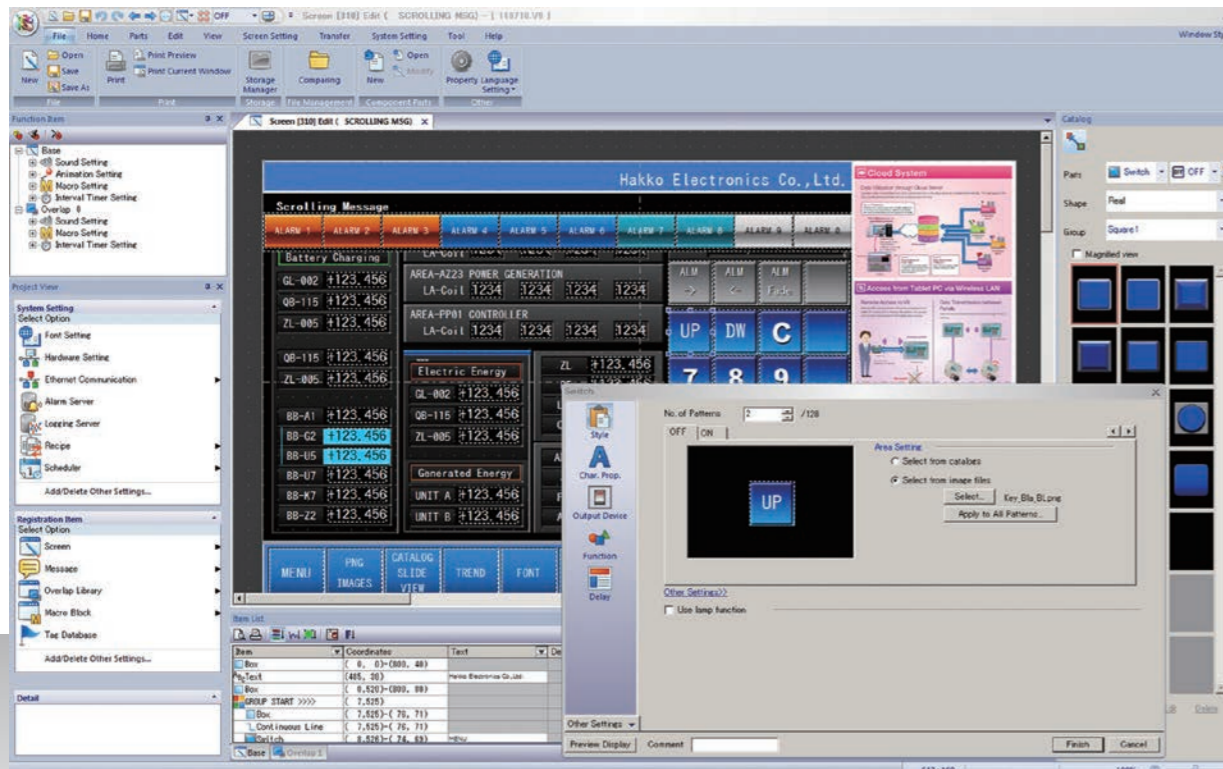

## V-SFT Ver. 6

|           |  |
|-----------|--|
| Computer  | PC/AT compatible computer running Windows  |
| OS*       | Windows XP/XP 64Edition/Windows Vista (32bit, 64bit)/Windows 7 (32bit, 64bit)/Windows 8 (32bit, 64bit)/Windows 8.1(32bit, 64bit)/Windows 10 (32bit, 64bit) |
| CPU       | Pentium 4 2.0GHz or higher is recommended  |
| Memory    | 1.0GB or higher (2.0GB or higher is recommended)   |
| Hard disk | When installed: 4.0GB or higher  |

|                |   |
|----------------|---|
| Disc drive     | DVD-ROM drive   |
| Display        | 1024 × 768 (XGA) resolution or higher   |
| Display colors | High color (16 bits) or higher  |
| Others         | Microsoft .NET Framework 4.0 or 4.5 (Microsoft .NET Framework 4.0 is installed automatically on computers that do not have either Microsoft .NET Framework 4.0 or 4.5 installed.) |

\*Administrator privileges are required for installation.

### Backward Compatibility with Previous Models

#### V8 series Compatibility

V-SFT Ver. 6 provides intuitive operation, with easy-to-use visual tools and refined displays. In addition to the V9 series, V-SFT Ver. 6 is also compatible with the V8 series.

#### Compatible with Program from Legacy Products

Screen data from previous models created in an older version of V-SFT can be converted as is to data for the current model. This allows anyone to leverage their screen data assets from previous models.

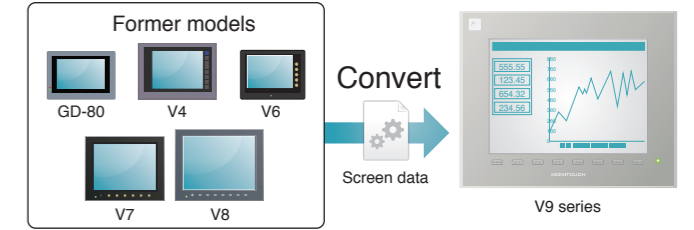

### Configuration of Easy-to-view Screens

#### Wider Range of Parts

The number of real world icons has been increased, and the icons with simple design have been added. Pick from the wide range of ready-made icons for sophisticated representation.



#### Simple Icons

A wide range of modern icon designs reminiscent of smartphones have been added.



#### Real World Icons

V-SFT adds more real world icons.



#### Improved 3D Parts Scaling Function

3D parts can be scaled up and down without changing the widths of frames. Frame size can be modified by batch, or individually according to the item type.

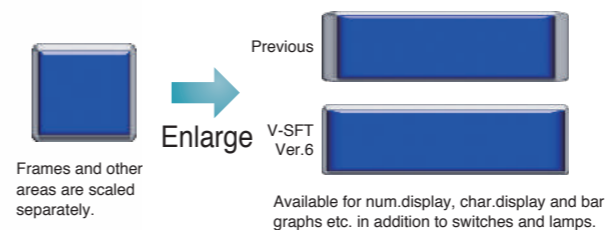

\* For the V9 series square picture icons and 3D parts with frames (excluding some icons and parts)

#### Line Width Setting

The line widths of graphic items and trend items (graph lines, reference lines) can now be set in eight steps. Effective screens can be created using a variety of drawing tools and graph representations.



\* Excluding thick lines

#### Copy/Paste of Microsoft Office Data

Graphics created in Microsoft Office Word, Excel and PowerPoint can be copied and pasted into V-SFT files by converting them to pictures, patterns or parts.

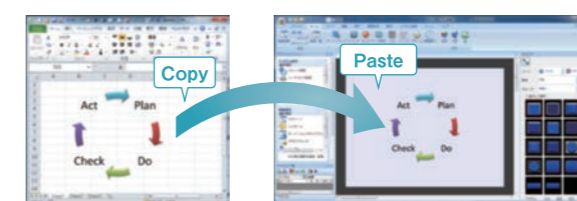

#### Pasting of an Image File

It is possible to paste a PNG file directly onto the screen. JPG, BMP and GIF formats are also supported as image files, allowing you to create whatever visually impressive screen you choose.

## Upgraded Operability

### Integration of Search Menu

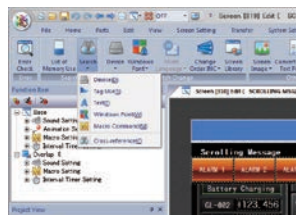

The search menu, which used to be displayed separately, has now been integrated for easy operation.

### Enhanced Interlock Setting

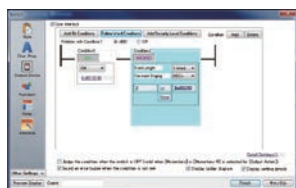

Interlock can be set with a ladder drawing screen. The condition settings are easy to understand and convenient even when setting multiple conditions. It is possible to set interlocking for keypad indication conditions in addition to switch conditions. Up to five conditions (AND or OR) for a bit device, word device or security level can be set, which is suitable for setting complicated conditions.

### Intuitively Grasp the Connection Device Configuration

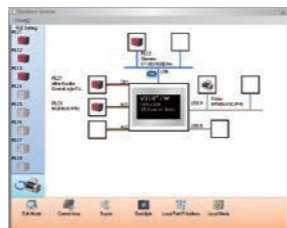

The improved hardware setting screen makes it easy to grasp exactly how devices are connected together in the system.

### Character String Table

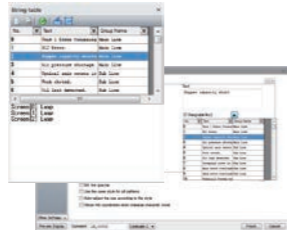

Text for switches, lamps and other parts can be managed centrally using the character string table. Frequently used text can be registered in the table for easy reference and batch modification. When a change occurs, you can make bulk changes simply by changing the string table.

\* Switches, lamps, text and multi text only.

## Data Batch Transfer Function

### Screen Data Batch Transfer (Ethernet)

Screen data can be transferred sequentially to multiple V9 series selected from the network.

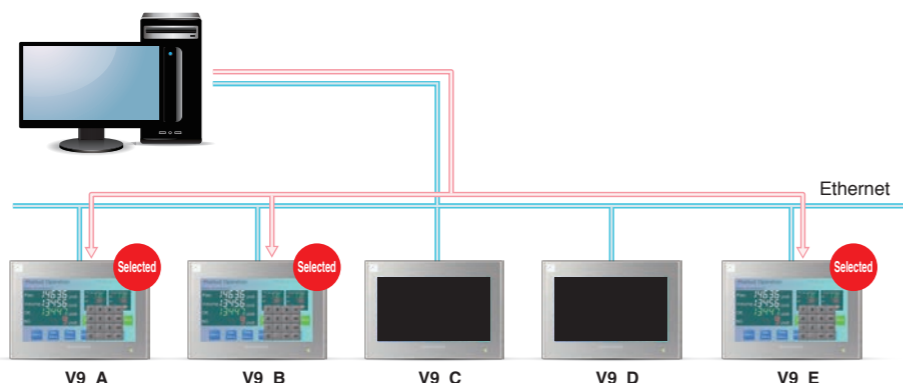
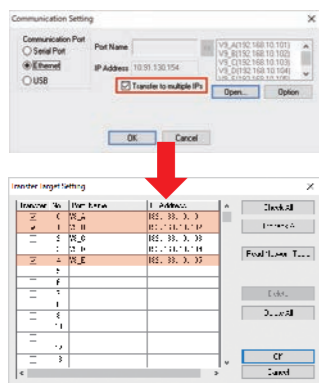

## V-SFT Ver.6 New Functionality

### Guideline Function

After arranging the items, this function displays guidelines by detecting surrounding items as you move and scale them. It enables user customization, such as whether to show or hide guidelines on an item-by-item basis, in order to increase your efficiency when aligning and arranging items.

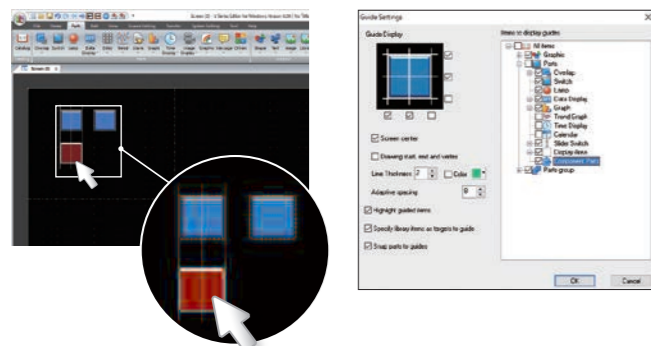

### Quick Access Toolbar

Quick Access toolbar is displayed at the top of the toolbar. The display icons can be freely customized by the user, as well as exported and imported. Therefore, they can be edited in the same environment even when switching or replacing computers.

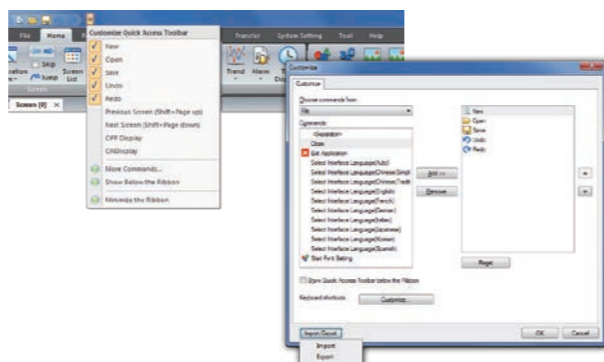

## Optional Accessories

### Expansion Units

#### GUR-00 (Video input 4ch)

Displays images from video cameras on V9 directly.

#### GUR-01 (RGB input 1ch)

Displays RGB input on V9.

#### GUR-02 (RGB output 1ch)

Displays images of V9 on a monitor.

#### GUR-04 (Video input 1ch)

Displays images from video cameras on V9 directly.

#### GUR-10 (Video input 2ch + RGB input 1ch)

Displays images from video camera and RGB input on V9 simultaneously.

#### GUR-11 (RGB input 2ch)

Displays RGB images such as PC images through two channels on V9 simultaneously.

### Communication Units

#### CUR-00 OPCN-1

CUR-06 SX Bus

#### CUR-01 T-Link

CUR-07 DeviceNet

#### CUR-02 CC-Link

CUR-08 FL-net

#### CUR-03 Ethernet

CUR-09 EtherCAT

#### CUR-04 PROFIBUS-DP

### Configuration Software

#### V-SFT Ver.6

Windows XP/XP 64Edition/Windows Vista (32bit, 64bit)/Windows 7 (32bit, 64bit)/Windows 8 (32bit, 64bit)/Windows 8.1 (32bit, 64bit)/Windows 10 (32bit, 64bit)

#### Editable Models

V9/TS2000/V8/TELLUS Ver.4/TELLUS Ver.3

### Cables

| Model  | Configuration                               | Configuration                          |
|--------|---|--|
| V-CP   | RS-232C Modular 8pin<br>Length: 3m          | PC                                     |
| V6-BCD | RS-232C Modular 8pin<br>Length: 3m          | Barcode reader                         |
| V6-MLT | RS-485 Modular 8pin<br>Length: 3m           | MONITOUCH V9/V8/V7/V6 /TS2000          |
| V6-TMP | RS-232C/485 Modular 8pin<br>Length: 3·5·10m | Temperature controller, Inverter, etc. |
| UA-FR  | Type A<br>Length: 1m                        | Card reader/writer, USB memory, etc.   |

### DUR-00 (Dedicated optional unit for V907xiW, V9060iTD, TS2060i)

Used for serial connection with D-Sub9pin.

### Other Accessories

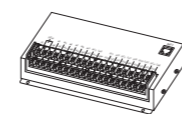

#### V-I/O (Serial expansion I/O unit)

This is an expansion I/O unit that connects to the MONITOUCH modular jack. Maximum 16 points can be used for both input and output.



#### TC-D9 (Terminal converter)

Connects V9 with other units via RS-422/485 terminal.



#### V9-BT

A replacement lithium battery for V9 series.  
\* Excluding the V907xiW and V9060iTD.



#### V7-BT

A replacement lithium battery for the V907xiW, V9060iTD and V8 series.

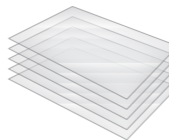

#### V9xxx-GS/V9xxx-GSN10

Protection sheets for panels. N10 is a non-glare type sheet. (5 sheets per set). See P.27 for details.

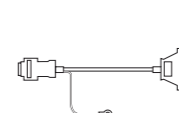

#### D9-D25

Replacement cable for CN1 cable of V6/V7 series. Length: 0.3m

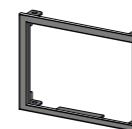

#### Panel adapter (PAD-Vxxx)

Used when fitting V9 into V4/GD-80/GD-65/GD-64 panel cutout. Contact our technical helpdesk for details.

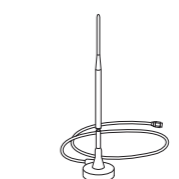

#### V9-ANT

Antenna for V9 models compatible with wireless LAN. Length: 3m

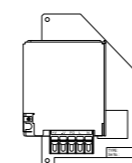

#### V9080C-PW

This is an AC to DC power converter for the V9080iCD. It can be used to replace existing GD-80E and V609E30M AC power supply models with the V9080iCD without having to change to a DC power supply.



# High-end specifications realize smooth and accurate operation.

## General Specifications

| Item                            | V9 Advanced                         |   | V9 Standard   |   |   |   |   |
|---------------------------------|-------------------------------------|---|---|---|---|---|---|
|                                 | V9101IW                             | V9071IW   | V9150iX   | V9150iXD  | V9120iS/V9120iSB  | V9120iSD/V9120iSBD  |   |
| Power Supply                    | Rated Voltage                       | DC24V   |   | AC100~240V  | DC24V   | AC100~240V  | DC24V   |
|                                 | Permissible Range of Voltage        | ±10%  |   | -15%,+10%   | ±10%  | -15%,+10%   | ±10%  |
|                                 | Permissible Momentary Power Failure | Within 1ms  |   | Within 20ms (100VAC or higher)                                  | Within 1ms  | Within 20ms (100VAC or higher)                                  | Within 1ms  |
|                                 | Power Consumption (Max. Rating)     | 27W or less   | 22W or less   | 90VA or less  | 40W or less   | 70VA or less  | 28W or less   |
|                                 | Rush Current                        | 17A or less, 6ms  | 10A or less, 6ms  | 30A or less, 3ms  | 19A or less, 7ms  | 30A or less, 3ms  | 18A or less, 5ms  |
| Insulation Resistance           | DC500V 10MΩ or more                 |   |   |   |   |   |   |
| Physical Environment            | Ambient Temperature                 | 0~50°C *1   |   | 0~40°C *1   |   | 0~50°C *1   |   |
|                                 | Ambient Humidity                    | 85%RH or less (without dew condensation) *1   |   |   |   |   |   |
|                                 | Operating Altitude                  | 2,000m or less  |   |   |   |   |   |
|                                 | Operating Atmosphere                | No exposure to corrosive gas or conductive dust   |   |   |   |   |   |
|                                 | Storage Temperature                 | -10~60°C *1   |   | -10~50°C *1   |   | -10~60°C *1   |   |
|                                 | Storage Humidity                    | 85%RH or less (without dew condensation) *1   |   |   |   |   |   |
|                                 | Pollution Degree                    | Pollution degree 2  |   |   |   |   |   |
| Mechanical Operating Conditions | Resistance to Oscillation           | JIS B 3502 (IEC61131-2) compliant, Vibration frequency 5 to 9Hz, Half amplitude: 3.5mm, 9 to 150Hz, Constant acceleration: 9.8m/s <sup>2</sup> (1G), X, Y, Z 3 directions 10 times each |   |   |   |   |   |
|                                 | Resistance to Shock                 | JIS B 3502 (IEC61131-2) compliant, Peak acceleration: 147m/s <sup>2</sup> (15G), X,Y,Z 3 directions, 3 times each (18 times in total)   |   |   |   |   |   |
| Electric Operating Conditions   | Resistance to Noise                 | Noise voltage:1,000Vp-p, pulse width:1μs, pulse rise time : 1ns   | Noise voltage:1,500Vp-p, pulse width:1μs, pulse rise time : 1ns | Noise voltage:1,000Vp-p, pulse width:1μs, pulse rise time : 1ns | Noise voltage:1,500Vp-p, pulse width:1μs, pulse rise time : 1ns | Noise voltage:1,500Vp-p, pulse width:1μs, pulse rise time : 1ns | Noise voltage:1,000Vp-p, pulse width:1μs, pulse rise time : 1ns |
|                                 | Resistance to Static Discharge      | Complies with IEC61000-4-2, contact: 6kV, air: 8kV  |   |   |   |   |   |
| Installation Conditions         | Grounding                           | Grounding resistance: Less than 100Ω, FG/SG separation  |   | Grounding resistance: Less than 100Ω, FG=SG                     |   | Grounding resistance: Less than 100Ω, FG/SG separation          |   |
|                                 | Structure                           | Protection structure: Front case: IP66, Type 4X/13 <sup>2,3</sup> (when water-proof gasket is used), Rear case: IP20, single unit, installation method: panel mounting                  |   |   |   |   |   |
|                                 | Cooling System                      | Natural air cooling   |   |   |   |   |   |
|                                 | Dimensions W*H*D (mm)               | 278.5 x 198.5 x 54.4  | 201.6 x 147.6 x 60.3  | 382.8 x 312.8 x 80.8  |   | 327.8 x 261.0 x 54.9  |   |
|                                 | Panel Cutout (mm)                   | 257.0 x 183.0 (+0.5/-0) mm  | 187.2 x 133.4 (+0.5/-0) mm                                      | 369.4 x 299.4 (+0.5/-0) mm                                      |   | 313.0 x 246.2 (+0.5/-0) mm                                      |   |
|                                 | Weight                              | Approx. 1.7 kg  | Approx. 1.0kg   | Approx. 4.7kg   |   | Approx. 2.5kg   |   |
| Case Color                      | Light gray                          |   | Front case: Silver, Rear case: Light gray                       |   | Light gray (black front housing for black model)                |   |   |
| Material                        | PC resin                            |   | Front case: Aluminum, Rear case: PC resin                       |   | PC resin  |   |   |

\*1 Use at a wet-bulb temperature of 39°C or less because higher temperatures may cause failure.

| Item                            | V9 Standard                                      |   |                            | V9 Lite                        |                            |                                |                    |   |
|---------------------------------|--|---|----------------------------|--------------------------------|----------------------------|--------------------------------|--------------------|---|
|                                 | V9100iS/V9100iSB                                 | V9100iSD/V9100iSBD  | V9080iSD/V9080iSBD         | V9100iC/V9100iCB               | V9100iCD/V9100iCBD         | V9080iCD/V9080iCBD             | V9060iTD/V9060iTBD |   |
| Power Supply                    | Rated Voltage                                    | DC24V   |                            | AC100~240V                     | DC24V                      | DC24V                          | DC24V              |   |
|                                 | Permissible Range of Voltage                     | ±10%  |                            | -15%,+10%                      | ±10%                       | ±10%                           | ±10%               |   |
|                                 | Permissible Momentary Power Failure              | Within 1ms  |                            | Within 20ms (100VAC or higher) | Within 1ms                 | Within 20ms (100VAC or higher) | Within 1ms         |   |
|                                 | Power Consumption (Max. Rating)                  | 70VA or less  | 28W or less                | 50VA or less                   | 17W or less                |                                | 13W or less        |   |
|                                 | Rush Current                                     | 30A or less, 3ms  | 17A or less, 6ms           | 30A or less, 3ms               | 17A or less, 6ms           |                                | 8A or less, 7ms    |   |
| Insulation Resistance           | DC500V 10MΩ or more                              |   |                            |                                |                            |                                |                    |   |
| Physical Environment            | Ambient Temperature                              | 0~50°C *1   |                            |                                |                            |                                |                    |   |
|                                 | Ambient Humidity                                 | 85%RH or less (without dew condensation) *1   |                            |                                |                            |                                |                    |   |
|                                 | Operating Altitude                               | 2,000m or less  |                            |                                |                            |                                |                    |   |
|                                 | Operating Atmosphere                             | No exposure to corrosive gas or conductive dust   |                            |                                |                            |                                |                    |   |
|                                 | Storage Temperature                              | -10~60°C *1   |                            |                                |                            |                                |                    |   |
|                                 | Storage Humidity                                 | 85%RH or less (without dew condensation) *1   |                            |                                |                            |                                |                    |   |
|                                 | Pollution Degree                                 | Pollution degree 2  |                            |                                |                            |                                |                    |   |
| Mechanical Operating Conditions | Resistance to Oscillation                        | JIS B 3502 (IEC61131-2) compliant, Vibration frequency 5 to 9Hz, Half amplitude: 3.5mm, 9 to 150Hz, Constant acceleration: 9.8m/s <sup>2</sup> (1G), X, Y, Z 3 directions 10 times each |                            |                                |                            |                                |                    |   |
|                                 | Resistance to Shock                              | JIS B 3502 (IEC61131-2) compliant, Peak acceleration: 147m/s <sup>2</sup> (15G), X,Y,Z 3 directions, 3 times each (18 times in total)   |                            |                                |                            |                                |                    |   |
| Electric Operating Conditions   | Resistance to Noise                              | Noise voltage: 1,500Vp-p, pulse width: 1μs, pulse rise time: 1ns  |                            |                                |                            |                                |                    | Noise voltage:1,000Vp-p, pulse width:1μs, pulse rise time : 1ns |
|                                 | Resistance to Static Discharge                   | Complies with IEC61000-4-2, contact: 6kV, air: 8kV  |                            |                                |                            |                                |                    |   |
| Installation Conditions         | Grounding  | Grounding resistance: Less than 100Ω, FG/SG separation  |                            |                                |                            |                                |                    |   |
|                                 | Structure  | Protection structure: Front case: IP66, Type 4X/13 <sup>2,3</sup> (when water-proof gasket is used), Rear case: IP20, single unit, installation method: panel mounting                  |                            |                                |                            |                                |                    |   |
|                                 | Cooling System                                   | Natural air cooling   |                            |                                |                            |                                |                    |   |
|                                 | Dimensions W*H*D (mm)                            | 303.8x231.0x54.0  | 235.0x180.0x48.9           | 303.8x231.0x54.0               | 235.0x180.0x48.9           | 182.5x138.8x53.0               |                    |   |
|                                 | Panel Cutout (mm)                                | 289.0 x 216.2 (+0.5/-0) mm  | 220.5 x 165.5 (+0.5/-0) mm | 289.0 x 216.2 (+0.5/-0) mm     | 220.5 x 165.5 (+0.5/-0) mm | 174.0 x 131.0 (+0.5/-0) mm     |                    |   |
|                                 | Weight   | Approx. 2.0kg   | Approx. 1.3kg              | Approx. 2.0kg                  | Approx. 1.3kg              | Approx. 740g                   |                    |   |
| Case Color                      | Light gray (black front housing for black model) |   |                            |                                |                            |                                |                    |   |
| Material                        | PC resin   |   |                            |                                |                            |                                |                    |   |

## Performance Specifications

| Item                 | V9 Advanced                    |  | V9 Standard                      |   |
|----------------------|--------------------------------|--|----------------------------------|---|
|                      | V9101IW                        | V9071IW  | V9150iX                          | V9120iS   |
| Screen Memory (FROM) | 64MB                           |  |                                  |   |
| Backup Memory (SRAM) | 800KB                          |  |                                  |   |
| Display              | Display Device                 | TFT color  |                                  |   |
|                      | Resolution W:H (dots)          | 1024x600   | 800x480                          | 1024x768  |
|                      | Display Size                   | 10.1" widescreen   | 7" widescreen                    | 15 Inch   |
|                      | Display Colors                 | 16.7 million *4  |                                  |   |
|                      | Backlight                      | LED  |                                  |   |
| Backlight Life       | 50,000 hours                   | 100,000 hours  |                                  | 70,000 hours  |
| Touch Switch         | Capacitance                    |  | Analog resistance film           |   |
| Function Switch      | Quantity: 8                    |  |                                  |   |
| External Interface   | D-Sub 9-pin (CN1) *5           | RS-232C/RS-422/RS-485<br>Asynchronous, Data length: 7, 8 bits Parity: Even, odd, none Stop bit: 1, 2 bits<br>Baud rate: 4800, 9600, 19200, 38400, 57600, 76800, 115200, 187500 *6 bps        |                                  |   |
|                      | Modular 8-pin (MJ1/MJ2)        | RS-232C/RS-422/RS-485 (2-wire type) *7<br>Asynchronous, Data length: 7, 8 bits Parity: Even, odd, none Stop bit: 1, 2 bits<br>Baud rate: 4800, 9600, 19200, 38400, 57600, 76800, 115,200 bps |                                  |   |
|                      | SD Card                        | One card slot provided as standard   |                                  |   |
|                      | Ethernet                       | 2ch, Baud rate: 100Mbps, 10Mbps  | 1ch, Baud rate : 100Mbps, 10Mbps |   |
|                      | Wireless LAN                   | Complies with IEEE802.11b/g/n (2.4GHz) *8  |                                  |   |
|                      | USB                            | Type A, Type mini-B (Ver.2.0)  |                                  |   |
| Sound Output         | 1ch provided as standard       | —  | 1ch provided as standard         |   |
| Clock                | Backup Period                  | 5 years (Ambient temperature 25°C)   |                                  |   |
|                      | Calendar Accuracy              | Gap ±90 sec. per month (Ambient temperature 25°C, When the battery is backed up)   |                                  |   |
| Standard             | CE Marking *2                  | EN61000-6-2, EN61000-6-4, EN50581  |                                  | EN61000-6-2, EN61000-6-4, EN50581 *9                          |
|                      | UL-cUL *2                      | UL61010 -1/UL61010-2-201(E313548)*10   |                                  | UL61010 -1/UL61010-2-201(E313548)*10, ANSI/ISA12.12.01 *11    |
|                      | KC                             | Compatible   |                                  | Compatible *9 *12   |
|                      | Radio Act *8                   | Japan: TELEC<br>USA: FCC<br>Canada: IC RSS   | Europe: RE<br>South Korea: KC    | Japan: TELEC  |
|                      | Classification Standard *2 *12 | —  |                                  | Nippon Kaiji Kyokai (NK)<br>Lloyd's Register of Shipping (LR) |

| Item                 | V9 Standard                    |  | V9 Lite  |   |          |  |
|----------------------|--------------------------------|--|----------|---|----------|--|
|                      | V9100iS                        | V9080iSD   | V9100iC  | V9080iCD  | V9060iTD |  |
| Screen Memory (FROM) | 64MB                           |  |          |   |          |  |
| Backup Memory (SRAM) | 800KB                          |  |          |   |          |  |
| Display              | Display Device                 | TFT color  |          |   |          |  |
|                      | Resolution W:H (dots)          | 800x600  |          | 640x480   |          |  |
|                      | Display Size                   | 10.4 Inch  | 8.4 Inch | 10.4 Inch   | 8.4 Inch | 5.7 Inch   |
|                      | Display Colors                 | 16.7 million *4  |          |   |          | 260 thousand *4  |
|                      | Backlight                      | LED  |          |   |          |  |
| Backlight Life       | 70,000 hours                   |  |          | 50,000 hours  |          |  |
| Touch Switch         | Analog resistance film         |  |          |   |          |  |
| Function Switch      | Quantity: 8                    |  |          |   |          |  |
| External Interface   | D-Sub 9-pin (CN1) *5           | RS-232C/RS-422/RS-485<br>Data length: 7, 8 bits Parity: Even, odd, none Stop bits: 1, 2 bits<br>Baud rate : 4800, 9600, 19200, 38400, 57600, 76800, 115200, 187500 *6 bps                    |          |   |          |  |
|                      | Modular 8-pin (MJ1/MJ2)        | RS-232C/RS-422/RS-485 (2-wire type) *7<br>Asynchronous, Data length: 7, 8 bits Parity: Even, odd, none Stop bit: 1, 2 bits<br>Baud rate: 4800, 9600, 19200, 38400, 57600, 76800, 115,200 bps |          |   |          |  |
|                      | SD Card                        | One card slot provided as standard   |          |   |          |  |
|                      | Ethernet                       | 1ch, Baud rate : 100Mbps, 10Mbps   |          |   |          |  |
|                      | Wireless LAN                   | Complies with IEEE802.11b/g/n (2.4GHz) *8  |          |   |          |  |
|                      | USB                            | Type A, Type mini-B (Ver.2.0)  |          |   |          |  |
| Sound Output         | 1ch provided as standard       |  | —        |   |          |  |
| Clock                | Backup Period                  | 5 years (Ambient temperature 25°C)   |          |   |          |  |
|                      | Calendar Accuracy              | Gap ±90 sec. per month (Ambient temperature 25°C, When the battery is backed up)   |          |   |          |  |
| Standard             | CE Marking *2                  | EN61000-6-2, EN61000-6-4, EN50581 *9   |          | EN61000-6-2, EN61000-6-4, EN50581                             |          |  |
|                      | UL-cUL *2                      | UL61010 -1/UL61010-2-201(E313548)*10, ANSI/ISA12.12.01 *11   |          | UL61010 -1/UL61010-2-201(E313548)*10, ANSI/ISA12.12.01 *11    |          |  |
|                      | KC                             | Compatible *9 *12  |          |   |          |  |
|                      | Radio Act *8                   | Japan: TELEC   |          |   |          |  |
|                      | Classification Standard *2 *12 | —  |          | Nippon Kaiji Kyokai (NK)<br>Lloyd's Register of Shipping (LR) |          | American Bureau of Shipping (ABS) *9<br>Det Norske Veritas (DNV) *13 |

\*2 DC products only. \*3 V9101IW: Hardware of Ver.c or later V9120iSD/V9100iSD/V9080iSD/V9100iCD/V9080iCD: Hardware of Ver.b or later V9071IW/V9150iXD/V9060iTD: All versions \*4 For displaying pictures, 3D parts, video, and RGB input (excluding high-speed mode) only. Other parts are displayed in 65,536 colors. \*5 Optional unit (DUR-00) is required for the V9071IW and V9060iTD. \*6 Only for Siemens MPI (Incompatible with DUR-00).

\*7 187,500 bps (four-wire system) for the V9071IW and V9060iTD MJ2 only. \*8 Wireless LAN-compatible products only. \*9 Wireless LAN compatible products are not supported. \*10 Only for Hardware Ver. f or later. Applicable standard for Hardware Ver. a to e is UL 508. \*11 V9120iSD/V9100iSD/V9080iSD: Hardware of Ver.b or later V9060iTD: All versions \*12 Black model not certified \*13 V9150iXD/V9060iTD: All V9120iSD: Hardware Ver.b or higher, V9100iSD/V9080iSD: Hardware Ver.c or higher.

# Flexible system configuration meets diversified requirements.

## Advanced Model System Configuration

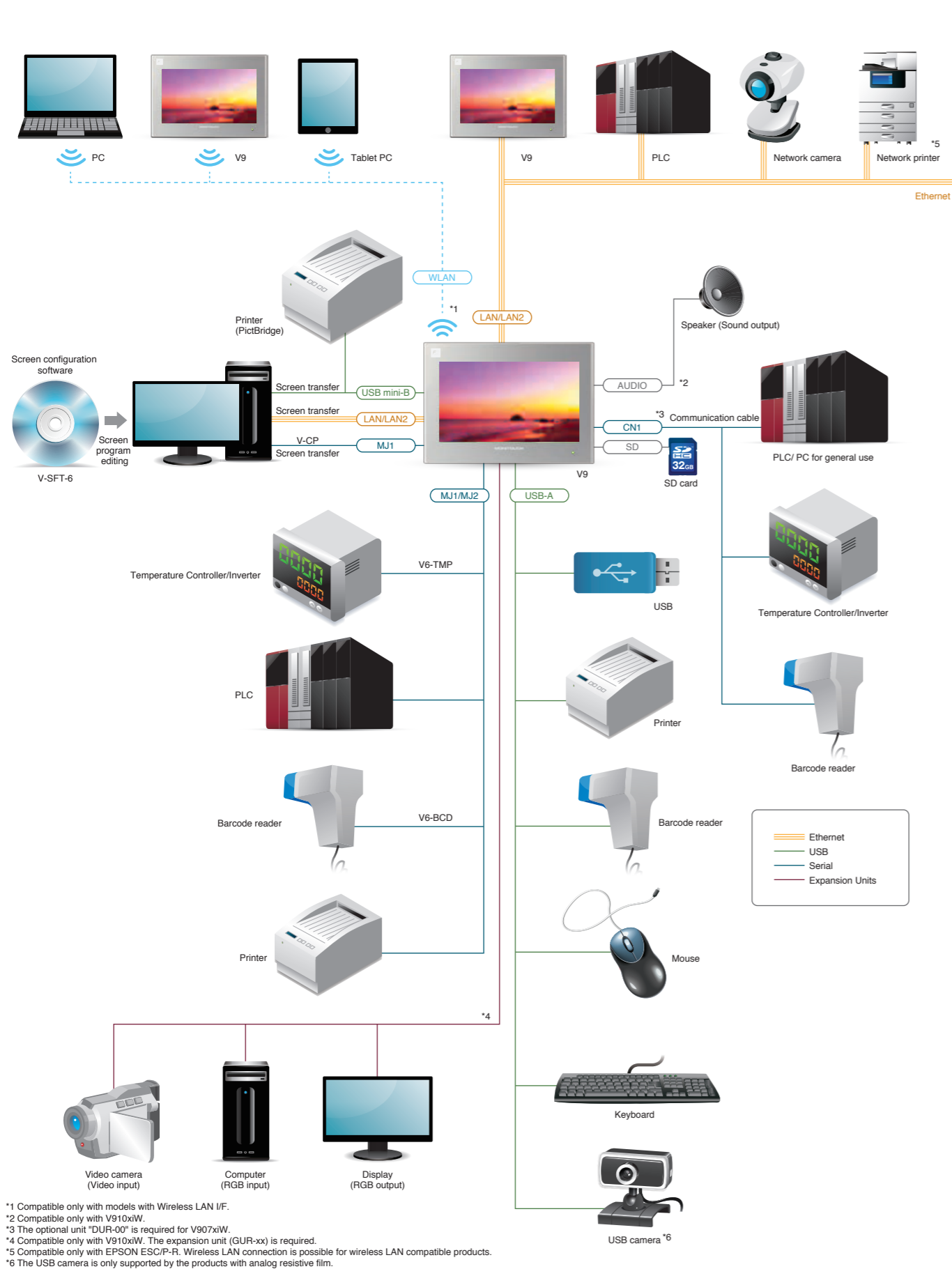

## Standard Model System Configuration

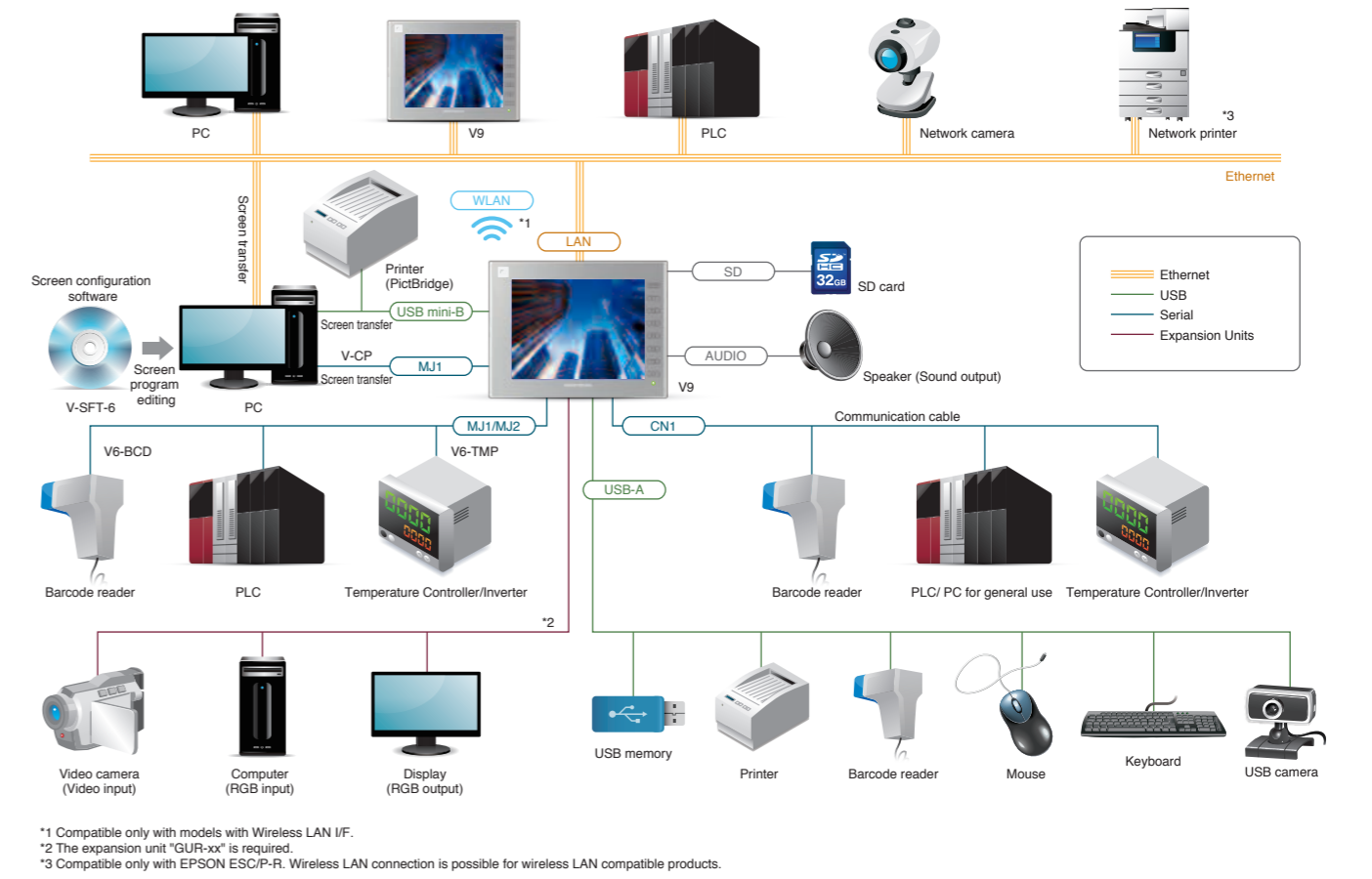

## Lite Model System Configuration

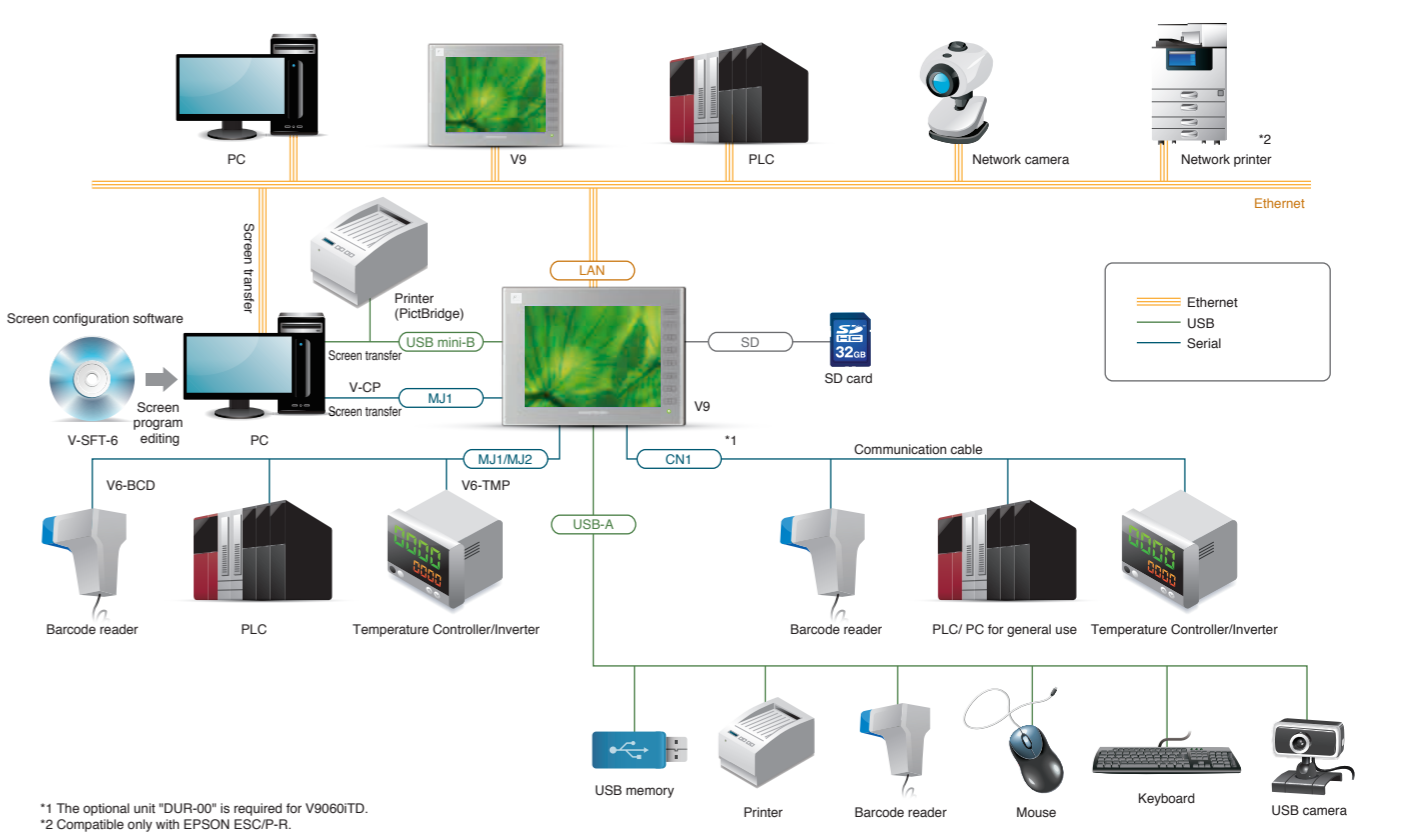



# Dimensions & Part Names

## V9 Advanced V9101iW (Unit: mm)

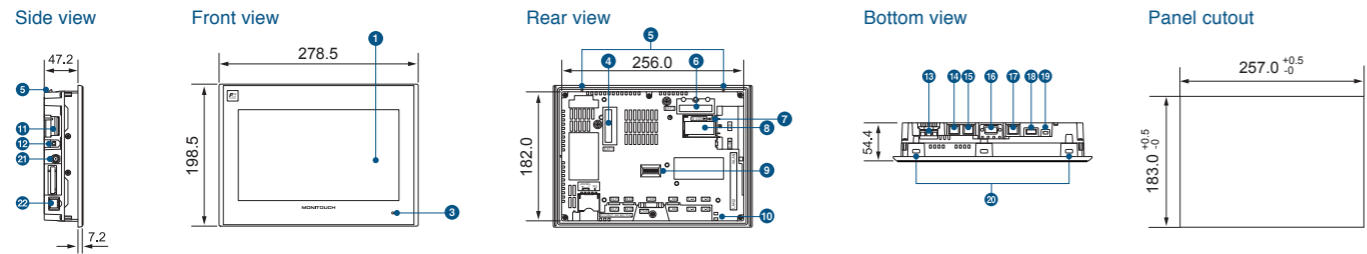

## V9 Advanced V9071iW (Unit: mm)

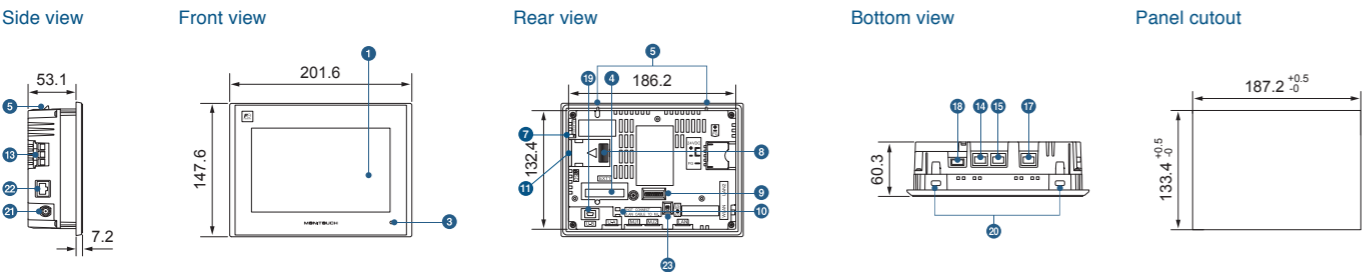

## V9 Standard V9150iX (Unit: mm)

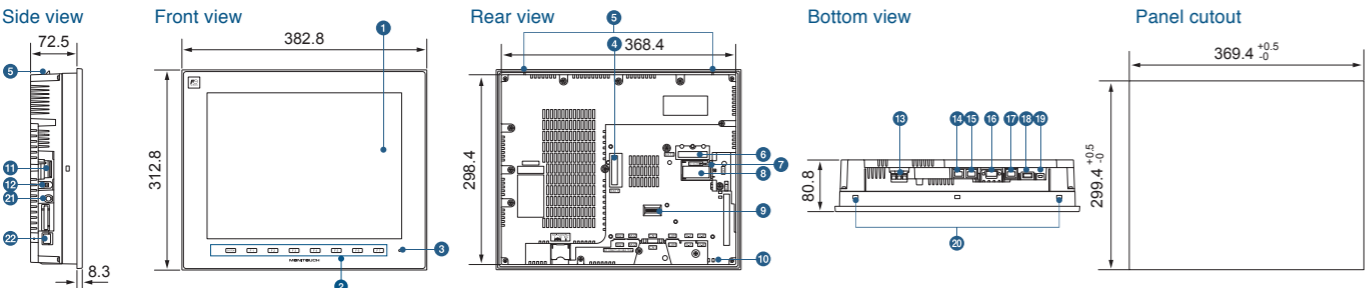

## V9 Standard V9120iS/V9120iSB (Unit: mm)

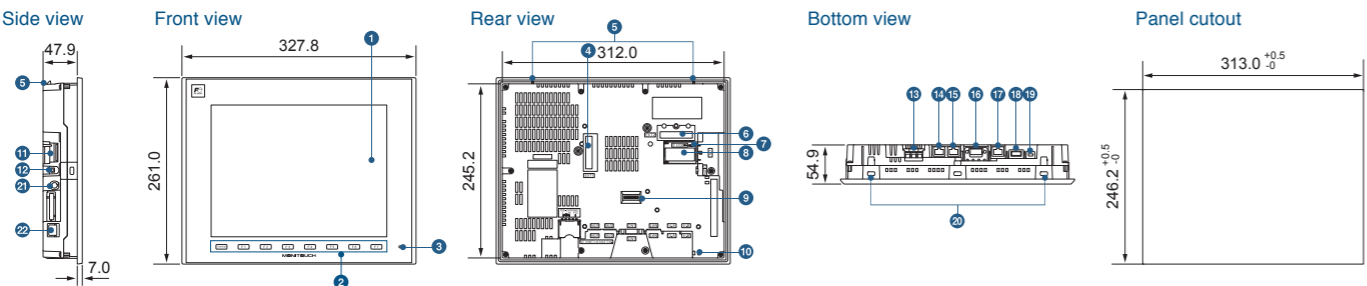

## V9 Standard V9100iS/V9100iSB (Unit: mm)

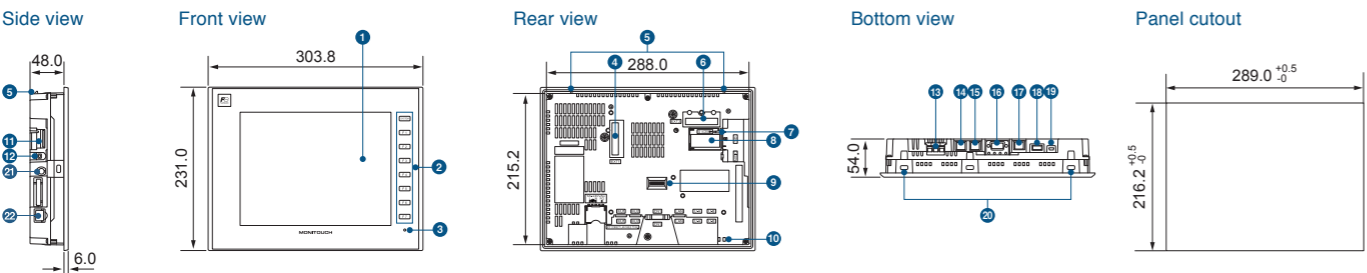

## V9 Standard V9080iSD/V9080iSBD (Unit: mm)

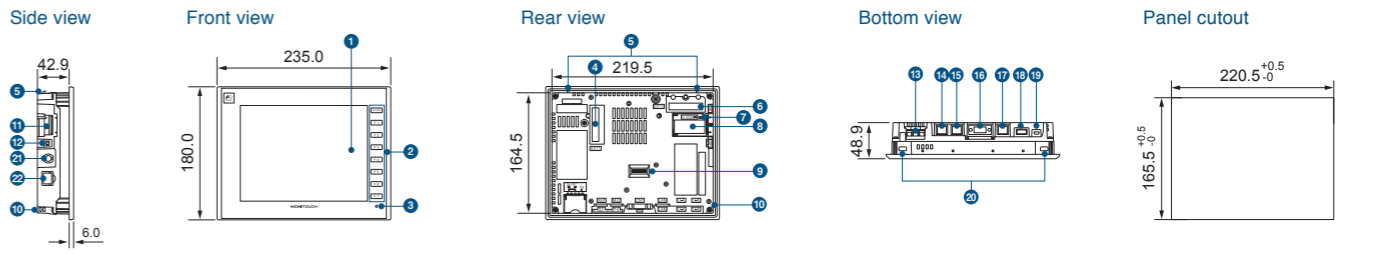

## V9 Lite V9100iC/V9100iCB (Unit: mm)

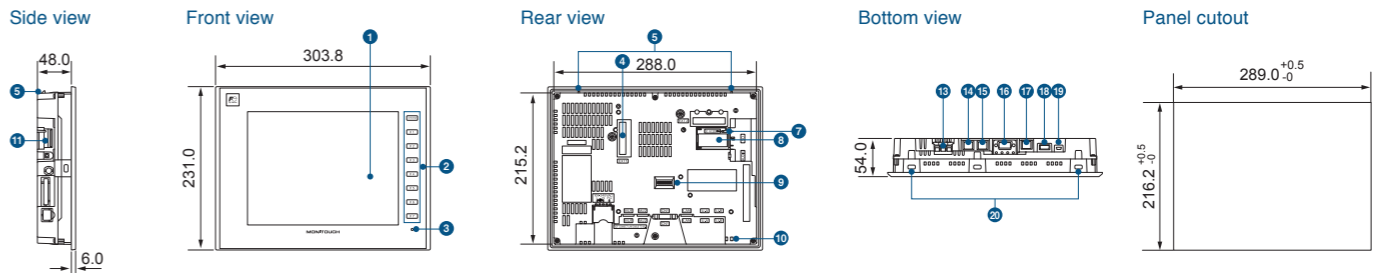

## V9 Lite V9080iCD/V9080iCBD (Unit: mm)

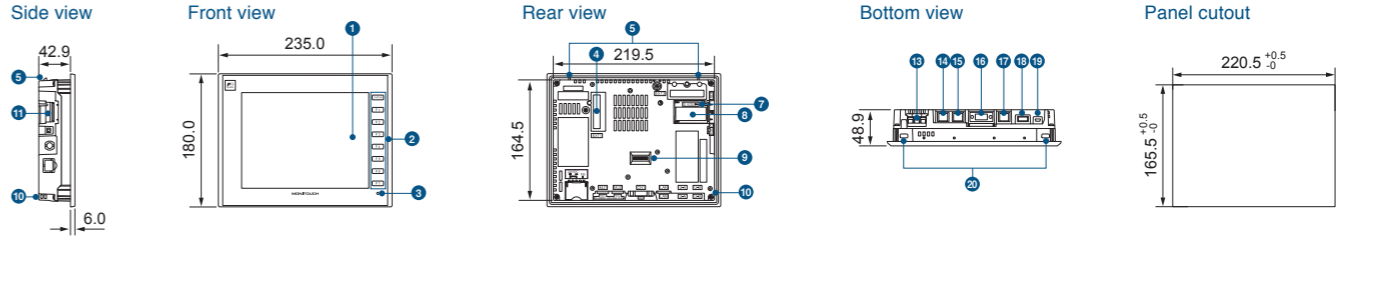

## V9 Lite V9060iTD/V9060iTBD (Unit: mm)

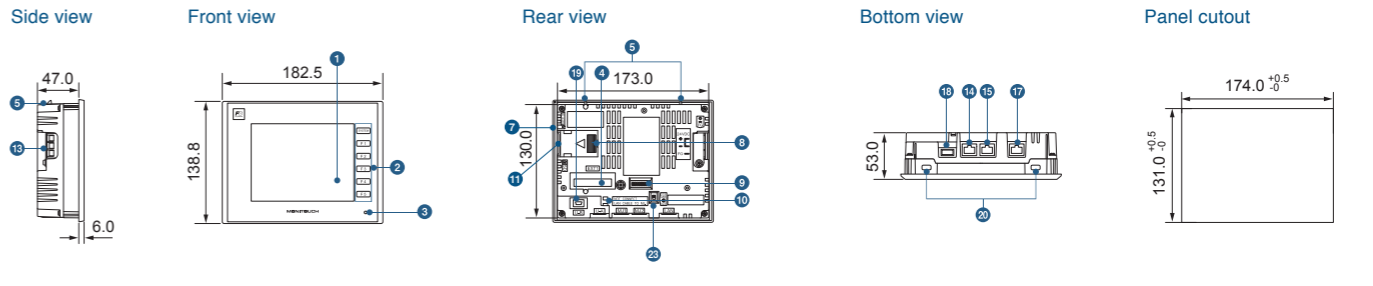

Part Names

|                                       |                                   |  |   |
|---------------------------------------|-----------------------------------|--|---|
| 1 Display                             | 7 SD card access LED              | 13 Power input terminal block          | 19 USB mini-B(U-B)                                |
| 2 Function switch                     | 8 Battery compartment             | 14 Modular jack 1 (MJ1)                | 20 Mounting point                                 |
| 3 Power lamp                          | 9 DIP switch                      | 15 Modular jack 2 (MJ2)                | 21 Wireless LAN external antenna connector (WLAN) |
| 4 Communication unit connector (EXT1) | 10 USB cable retention            | 16 PLC connector (CN1)                 | 22 100BASE-TX/10BASE-T connector (LAN2)           |
| 5 Fall prevention hook                | 11 SD card connector              | 17 100BASE-TX/10BASE-T connector (LAN) | 23 Slide switch                                   |
| 6 Expansion unit connector (EXT2)     | 12 Sound output connector (AUDIO) | 18 USB-A(U-A)                          |   |





# MONITOUCH wide-variety product lineup

## TS2000 series

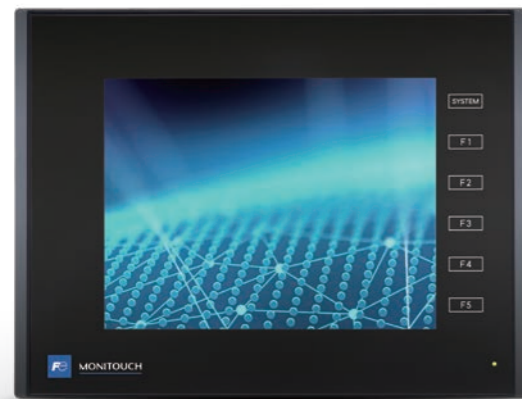

# TECHNOSHOT

5.7 inch QVGA 64K Color TFT LED Backlight 2ch Serial USB miniB DC Power supply



With Ethernet port  
**TS2060i**  
No Ethernet port  
**TS2060**

10.5M FROM 512k SRAM USB A SD Card Ethernet Communication Units

2.5M FROM 128k SRAM

\*1 "DUR-00" or "CUR-xx" is mountable.

### Specifications

|                         | TS2060   | TS2060i   |
|-------------------------|--|---|
| Screen Memory (FROM)    | 2.5Mbyte   | 10.5Mbyte   |
| Backup Memory (SRAM)    | 128Kbyte   | 512Kbyte  |
| Stroke Font             | -  | Compatible  |
| Display                 | Display Device   | TFT color   |
|                         | Resolution W:H (dots)  | 320 x 240   |
|                         | Display Size   | 5.7 inch (QVGA)   |
|                         | Display Colors   | 65,536 colors(The software is compatible with displays in 32K colors, 256 colors, 128 colors and monochrome.)   |
|                         | Backlight  | LED   |
|                         | Backlight Life   | 50,000 hours  |
|                         | Touch Switch   | Type  |
| Function Switch         | Quantity   | 6   |
| External Interface      | D-Sub 9-pin <sup>2</sup>   | RS-232C/RS-422/RS-485, asynchronous type, Data length: 7, 8 bits, Parity: odd, even, none, Stop bit: 1, 2 bits, Baud rate: 4800, 9600, 19200, 38400, 57600, 76800, 115200 bps   |
|                         | Modular 8-pin(MJ1/2)   | RS-232C/RS-422 (4-wire system) <sup>3</sup> /RS-485 (2-wire system), Asynchronous type, Data length: 7, 8 bits, Parity: even, odd, none Stop bit: 1, 2 bits, Baud rate: 4800, 9600, 19200, 38400, 57600, 76800, 115200, 187500 <sup>4</sup> bps |
|                         | SD Card  | -   |
|                         | Ethernet   | -   |
|                         | USB  | Type mini-B(Ver. 2.0)   |
|                         | Communication Units  | -   |
|                         | Power Supply   | Permissible Range of Voltage  |
| Physical Environment    | Power Consumption (max. rating)  | 13W or less   |
|                         | Ambient Temperature  | 0°C to +50°C <sup>5</sup>   |
|                         | Ambient Storage Temperature  | -10°C to +60°C <sup>5</sup>   |
|                         | Ambient Humidity   | 85% RH or less (without dew condensation) <sup>5</sup>  |
|                         | Ambient Storage Humidity   | 85% RH or less (without dew condensation) <sup>5</sup>  |
|                         | Operating Altitude   | 2,000m or less  |
|                         | Operating Atmosphere   | Not exposed to corrosive gas or excessive dust (free of conductive dust)  |
| Installation Conditions | Contamination Level  | Contamination level2  |
|                         | Grounding  | Grounding resistance: Less than 100Ω, FG/SG separation  |
|                         | Protective Structure   | Front panel : Compatible with IP65 (when gasket is used), Rear cover : Compatible with IP20   |
|                         | Cooling System   | Natural air cooling   |
|                         | Dimensions WxHxD   | 182.5 x 138.8 x 45.8mm  |
|                         | Panel Cutout   | 174.0 <sup>+0.5</sup> x 131.0 <sup>+0.5</sup> mm (equivalent to V806/V606e/S806/V706/V606)  |
| Standard                | CE (EN61000-6-2, EN61000-6-4, EN50581), KC, UL61010-1, UL61010-2-201 (E313548) |   |
| Case Color              | Black  |   |
| Battery                 | Built-in button battery / Battery life : 5 years (ambient temperature 25°C)    |   |

<sup>2</sup> Only when mounting the optional unit (DUR-00) to the TS2060i. <sup>3</sup> Only MJ2 is compatible with 4-wire system.

<sup>4</sup> 187500 bps only applies to Siemens MPI/PPi connections. MPI/PPi supports only MJ2. <sup>5</sup> Use at a wet-bulb temperature of 39°C or less because higher temperatures may cause failure.

## V8 Handy Type



# V808CH

7.5 inch VGA 64K Color TFT LED Backlight 2ch Serial CF Card USB B DC Power supply



With Ethernet port  
**V808iCH**  
No Ethernet port  
**V808CH**

12.5M FROM 512k SRAM Ethernet

4.5M FROM 128k SRAM

### V808CH Models

V808 CH

|   | Key switch | Deadman switch |                 |
|---|------------|----------------|-----------------|
|   |            | Type           | External output |
| 0 | N/A        | Momentary      | N/A             |
| 1 | Equipped   | Momentary      | N/A             |
| 2 | N/A        | 3-position     | 1-contact       |
| 3 | Equipped   | 3-position     | 1-contact       |
| 4 | N/A        | 3-position     | 2-contact       |

Feature Specifications  
N/A: No built-in LAN port  
i: Built-in LAN port

### Specifications

|                     | V808iCHx  | V808CHx  |                  |
|---------------------|---|--|------------------|
| Basic Specs         | Display Size  | 7.5 inch (VGA)   |                  |
|                     | Display Device  | TFT color LCD  |                  |
|                     | Resolution W:H (dots)   | 640 x 480 dots   |                  |
|                     | Display Colors  | 65,536 colors (no blink) / 32,768 colors (with blink)  |                  |
|                     | Screen Memory(FROM)   | FROM (12.5M byte)  | FROM (4.5M byte) |
|                     | Backup Memory(SRAM)   | SRAM (512K byte)   | SRAM (128K byte) |
|                     | Clock   | Equipped   |                  |
|                     | Ethernet  | 100BASE-TX/10BASE-T provided as standard   | N/A              |
|                     | CF Card I/F   | Equipped   |                  |
|                     | USB I/F   | Type B (Ver 1.1)   |                  |
| Function Switch     | Quantity  | 12 (4 : external output)   |                  |
|                     | Type  | Membrane switch  |                  |
| Touch Switch        | Mechanical Life Expectancy  | 1,000,000 times or more  |                  |
|                     | Type  | Push lock system (b-contact, 2 circuits)   |                  |
|                     | Mechanical Life Expectancy  | 100,000 times or more  |                  |
|                     | Rated Voltage   | DC24V  |                  |
| Key Switch          | Rated Current   | 1A (load resistance)   |                  |
|                     | Contact   | a-contact, 1 circuit   |                  |
|                     | Mechanical Life Expectancy  | 250,000 times or more  |                  |
| Deadman Switch      | Electrical Life Expectancy  | 100,000 times or more (operating cycles: 1200 times/hour)  |                  |
|                     | Type  | 3-position output (a-contact, 2 circuits <sup>1</sup> )  |                  |
|                     | Rated Voltage   | DC24V  |                  |
|                     | Rated Current   | 1A (load resistance)   |                  |
| External I/F        | Type  | Momentary  |                  |
|                     | Mechanical Life Expectancy  | 1,000,000 times or more  |                  |
|                     | TB2   | RS232C, Data length : 7, 8 bits, Parity: Even, odd, none Stop bit: 1, 2 bits Baud rate: 4800, 9600, 19200, 38400, 76800, 115,200 bps |                  |
| TB3                 | RS-422/485, Asynchronous type; Data length: 7, 8 bits Parity: Even, odd, none Stop bit: 1, 2 bits Baud rate: 4800, 9600, 19200, 38400, 76800, 115200, 187500 <sup>2</sup> bps |  |                  |
| Applicable Standard | CE Marking  |  |                  |
|                     | EN61000-6-2, EN61000-6-4, EN50581   |  |                  |

<sup>1</sup> Only V808(i)CH4 comes with a-contact and 2 circuits. V808(i)CH2,3 only have 1 circuit.  
<sup>2</sup> 187500 bps only applies to Siemens MPI/PPi connections.

### Optional Accessories List

| Model        | Product  |
|--------------|--|
| V8H-C□       | V808CH external connection cable (□ =3, 5,15, 20m) |
| V7-BT        | V8, V7, V606e battery                              |
| V8H-SWG      | V808CH switch guard                                |
| V6H-WF       | V808CH wall mounting bracket set                   |
| V6H-WF1      | V808CH wall mounting bracket (wall side)           |
| V8H-WFV      | V808CH fixing bracket (VESA compliant)             |
| V8H-ST       | V808CH stand                                       |
| V608CH-GSN10 | V808CH/V608CH protection sheets (Non-glare)        |

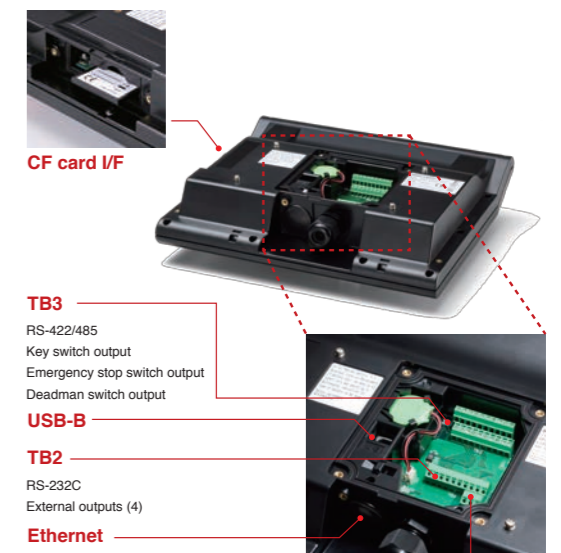

CF card I/F

TB3

RS-422/485  
Key switch output  
Emergency stop switch output  
Deadman switch output

USB-B

TB2

RS-232C  
External outputs (4)

Ethernet

TB1

Power supply (24 V)







# Worldwide service network for trouble-free

TEL

FAX

TEL. +81-76-274-2144 FAX. +81-76-274-5136

E-mail

✉ sales@hakko-elec.co.jp

WEB

www.monitouch.com



## Global Sales Network

Our distributors are ready to support your worldwide business.

[www.monitouch.com/site/distributors-e/distributors-oversea-01.html](http://www.monitouch.com/site/distributors-e/distributors-oversea-01.html)



# Operations

## To the purchasers:

The warranty of this product is as follows, unless there are special instructions that state otherwise in the quote, contract, catalog, or specifications at the time of the quote or order.

The purpose or area of use may be limited, and a routine checkup may be required depending on the product. Please contact the distributor from which you purchased the product, or Fuji Electric / Hako Electronics for further information.

Please conduct inspection of the product promptly upon purchase or delivery. Also, please give sufficient consideration to management and maintenance of the product prior to accepting it.

### 1 Period and Coverage of the Warranty

#### 1-1 Period

- (1) The period of the warranty is effective until twenty-four (24) months from the date of manufacture printed on the plate.
- (2) The above period may not be applicable if the particular environment, conditions or frequency of use affects the lifetime of the product.
- (3) The warranty for the parts repaired by our service department is effective for six (6) months from the date of repair.

#### 1-2 Coverage

- (1) If malfunction occurs during the period of warranty due to negligence on the part of Fuji Electric / Hako Electronics, the malfunctioning parts are exchanged or repaired free of charge at the point of purchase or delivery. However, the warranty does not apply to the following cases:
  - 1) The malfunction occurs due to inappropriate conditions, environment, handling or usage that is not specified in the catalog, instruction book or users' manual.
  - 2) The malfunction is caused by factors that do not originate in the purchased or delivered product.
  - 3) The malfunction is caused by another device or software design that does not originate in a Fuji Electric / Hako Electronics product.
  - 4) The malfunction occurs due to an alteration or repair that was not performed by Fuji Electric / Hako Electronics.
  - 5) The malfunction occurs because the expendable parts listed in the instruction book or catalog were not maintained or replaced in an appropriate manner.
  - 6) The malfunction occurs due to factors that were not foreseeable by the practical application of science and technology at the time of purchase or delivery.
  - 7) The malfunction occurs because the product is used for a purpose other than that for which it is intended.
  - 8) The malfunction occurs due to a disaster or natural disaster that Fuji Electric / Hako Electronics are not responsible for.
- (2) The warranty is only applicable to the single purchased and delivered product.
- (3) The warranty is only valid for the conditions stated in (1) above. Any damage induced by the malfunction of the purchased or delivered product, including damage or loss to a device or machine and passive damage, is not covered by the warranty.

#### 1-3 Malfunction Diagnosis

The initial diagnosis of malfunction is to be made by the purchaser. The diagnosis can be conducted by Fuji Electric / Hako Electronics or our delegated service provider with due charge upon the request of the purchaser. The charge is to be paid by the purchaser at the rate stipulated in the rate schedule of Fuji Electric / Hako Electronics.

### 2 Liability for Opportunity Loss

Regardless of the time of occurrence, Fuji Electric / Hako Electronics are not liable for damage caused by factors that Fuji Electric / Hako Electronics are not responsible for, opportunity loss on the part of the purchaser caused by the malfunction of a Fuji Electric / Hako Electronics product, passive damage, damage due to a special situation regardless of whether it was foreseeable or not, or secondary damage, accident compensation, damage to products that were not manufactured by Fuji Electric / Hako Electronics, or compensation towards other operations.

### 3 Period for Repair and Provision of Spare Parts after Production is Discontinued (Maintenance Period)

Discontinued models (products) can be repaired for seven (7) years from the date of discontinuation. Also, most spare parts used for repair are provided for seven (7) years from the date of discontinuation. However, some electric parts may not be available due to their short life cycle. In this case, it may be difficult to repair or provide the parts during the seven-year period. Please contact Fuji Electric / Hako Electronics or our service providers for further information.

### 4 Delivery

Standard products that do not entail application setting or adjustment are regarded as received by the purchaser upon delivery. Fuji Electric / Hako Electronics are not responsible for local adjustments and test runs.

### 5 Service

The price of the delivered or purchased products does not include the service fee for the technician. Please contact Fuji Electric / Hako Electronics or our service providers for further information.

### 6 Scope of Application

The above contents shall be assumed to apply to transactions and product use in the country where a Fuji Electric / Hako Electronics product is purchased. Please consult your local supplier or Fuji Electric / Hako Electronics for details.



## Safety Considerations

- For safe operation, read the instruction manual or user manual that comes with the product carefully or consult the distributor from which you purchased the product, before using the product.
- Products introduced in this catalog have not been designed or manufactured for such applications in a system or equipment that will affect human bodies or lives.
- Customers, who want to use the products introduced in this catalog for special systems or devices such as for atomic-energy control, aerospace use, medical use, passenger vehicle, and traffic control, are requested to consult the Hakko Overseas Sales Section.
- Customers are requested to prepare safety measures when they apply the products introduced in this catalog to such systems or facilities that will affect human lives or cause severe damage to property if the products become faulty.
- For safe operation, wiring should be conducted only by qualified engineers who have sufficient technical knowledge about electrical work or wiring.

## Notes to consider before purchasing

- Appearance and specifications are subject to modification without prior notice due to technical improvements.
- Colors in the catalog may differ from the actual colors due to printing inaccuracies.
- Consult your distributor or us for further information about products in this catalog.

**[www.monitouch.com](http://www.monitouch.com)**

Sales company :

**Fuji Electric Co.,Ltd.**

URL : [www.fujielectric.com](http://www.fujielectric.com)

Gate City Ohsaki, East Tower,

11-2, Osaki 1-chome, Shinagawa-ku,

Tokyo 141-0032, Japan

Phone : +81-3-5435-7066

Fax : +81-3-5435-7475

Manufacturer :

**Hakko Electronics Co., Ltd.**

URL : [www.monitouch.com](http://www.monitouch.com)

890-1 Kamikashiwano-machi,

Hakusan, Ishikawa 924-0035, Japan

Phone : +81-76-274-2144

Fax : +81-76-274-5136

E-mail : [sales@hakko-elec.co.jp](mailto:sales@hakko-elec.co.jp)



[www.monitouch.fujielectric.com/site/v9-e/](http://www.monitouch.fujielectric.com/site/v9-e/)

Distributor

\* Product specifications and design are subject to modification.  
\* Combined images are used for the screen images.  
\* Product colors may differ from colors in brochure photos due to printing.  
\* Microsoft and Windows are trademarks of Microsoft (USA) in the U.S. and other countries.  
\* Other company and product names in this brochure are registered trademarks.