

Hardware Specifications

MONITOUCH V7 Series



Record of Revisions

Reference numbers are shown at the bottom left corner on the back cover of each manual.

Printing Date	Reference No.	Revised Contents
September, 2002	2010NE0	First edition
April, 2003	2010NE1	Second edition <ul style="list-style-type: none"> • Ladder Transfer Function MITSUBISHI Q00/Q01, FX/FX1S/FX2N series • PLC2Way MITSUBISHI QnH (Q) series CPU, FX series link (A protocol) • OMRON CS1/CS1DNA (Ethernet) • ALLEN-BRADLEY PLC5, SLC500, Control Logix (Ethernet) • SIEMENS S7-300/400MPI, S7-300MPI Helmholtz SSW7 ADP • KEYENCE KV-700 (Ethernet) • LG GLOFA GM series CPU • IDEC MICRO Smart
February, 2004	2010NE2	Third edition <ul style="list-style-type: none"> • Information on connections with PLCs put into a separate volume entitled "PLC Connection Manual" • Information on the matrix switch type added • Information on V710C added
March, 2006	2010NE3	Fourth edition <ul style="list-style-type: none"> • Information on CU-07(DeviceNet) added • 100BASE-TX supported • Address revised, etc.
June, 2008	2010NE4	Fifth edition <ul style="list-style-type: none"> • Cover and back cover changed

Preface

Thank you for selecting the MONITOUCH V7 series.

For correct set-up of the V7 series, you are requested to read through this manual to understand more about the product.

For more information about the V7 series, refer to the following related manuals.

Manual Name	Contents	Reference No.
Reference Manual (Operation)	The V-SFT operating procedure is described.	1043NE
Reference Manual (Function)	The functions and instructions of the V7/V6 series are explained.	1044NE
PLC Connection Manual	Connections with various PLCs and universal serial communications are explained.	2200NE
Temperature Control Network	The temperature control network function is explained.	1033NE
Specifications for CC-LINK Communication Unit	Instructions for CC-LINK are contained.	1028NE
Specifications for PROFIBUS Communication Unit	Instructions for PROFIBUS are contained.	1036NE
Connection with AB Control Logix	The connection, communication parameters and tag setting for AB Control Logix are explained.	1041NE
M-CARD SFT Operation Manual	The operating procedure of the memory card editor is described.	1023NE
V-SFT Additional Specifications	Additional specifications for the Reference Manual are explained.	5044NE
Ladder Monitor Specifications	Instructions for the ladder monitor function are contained.	1045NE

For further details about PLCs (programmable logic controllers), see the manual attached to each PLC.

Notes:

1. This manual may not, in whole or in part, be printed or reproduced without the prior written consent of Hakko Electronics Co., Ltd.
2. The information in this manual is subject to change without prior notice.
3. Windows and Excel are registered trademarks of Microsoft Corporation in the United States and other countries.
4. All other company names or product names are trademarks or registered trademarks of their respective holders.
5. This manual is intended to give accurate information about MONITOUCH hardware. If you have any questions, please contact your local distributor.

Notes on Safe Use of MONITOUCH

In this manual, you will find various notes categorized under the following levels with the signal words "DANGER," and "CAUTION."



DANGER

Indicates an imminently hazardous situation which, if not avoided, will result in death or serious injury.



CAUTION

Indicates a potentially hazardous situation which, if not avoided, may result in minor or moderate injury and could cause property damage.

Note that there is a possibility that the item listed with  CAUTION may have serious ramifications.



DANGER

- Never use the input function of MONITOUCH for operations that may threaten human life or to damage the system, such as switches to be used in case of emergency. Please design the system so that it can cope with malfunction of a touch switch. A malfunction of the touch switch will result in machine accident or damage.
- Turn off the power supply when you set up the unit, connect cables or perform maintenance and inspection. Otherwise, electrical shock or damage may occur.
- Never touch any terminals while the power is on. Otherwise, electric shock may occur.
- You must put a cover on the terminals on the unit when you turn the power on and operate the unit. Without the terminal cover in place, an electric shock may occur.
- The liquid crystal in the LCD panel is a hazardous substance. If the LCD panel is damaged, never swallow the leaked liquid crystal. If the liquid crystal spills on your skin or clothing, use soap and wash off thoroughly.
- For MONITOUCH using a lithium battery, never disassemble, recharge, deform by pressure, short-circuit, nor reverse the polarity of the battery, and never dispose of the battery in fire. Failure to follow these conditions will lead to explosion or ignition.
- For MONITOUCH using a lithium battery, never use a battery that is deformed, leaks, or shows any other signs of abnormality. Failure to follow these conditions will lead to explosion or ignition.

 **CAUTION**

- Check the appearance of the unit when it is unpacked. Do not use the unit if any damage or deformation is found. Failure to do so may lead to fire, damage or malfunction.
- For use in a facility or for a system related to nuclear energy, aerospace, medical, traffic equipment, or mobile installations, please consult your local distributor.
- Operate (or store) MONITOUCH under the conditions indicated in this manual and related manuals. Failure to do so could cause fire, malfunction, physical damage or deterioration.
- Understand the following environmental limits for use and storage of MONITOUCH. Otherwise, fire or damage to the unit may result.
 - Avoid locations where there is a possibility that water, corrosive gas, flammable gas, solvents, grinding fluids or cutting oil can come into contact with the unit.
 - Avoid high temperature, high humidity, and outside weather conditions, such as wind, rain or direct sunlight.
 - Avoid locations where excessive dust, salt, and metallic particles are present.
 - Avoid installing the unit in a location where vibration or physical shock may be transmitted.
- Equipment must be correctly mounted so that the main terminal of MONITOUCH will not be touched inadvertently. Otherwise, an accident or electric shock may occur.
- Tighten the fixtures of the MONITOUCH with a torque in the specified range. Excessive tightening may distort the panel surface. Loose tightening may cause MONITOUCH to come off, malfunction or be short-circuited.
- Check periodically that terminal screws on the power supply terminal block and fixtures are firmly tightened. Loosened screws may result in fire or malfunction.
- Tighten terminal screws on the power supply terminal block equally to a torque of 0.5 N•m. Improper tightening of screws may result in fire, malfunction, or trouble.
- MONITOUCH has a glass screen. Do not drop or give physical shock to the unit. Otherwise, the screen may be damaged.
- Connect the cables correctly to the terminals of MONITOUCH in accordance with the specified voltage and wattage. Over-voltage, over-wattage or incorrect cable connection could cause fire, malfunction or damage to the unit.
- Be sure to establish a ground of MONITOUCH. Ground FG terminal which must be used for the unit. Otherwise, electric shock or a fire may occur.
- Prevent any conductive particles from entering into MONITOUCH. Failure to do so may lead to fire, damage or malfunction.
- After wiring is finished, remove the paper used as a dust cover before starting to operate MONITOUCH. Operation with the cover attached may result in accident, fire, malfunction, or trouble.
- Do not attempt to repair MONITOUCH at your site. Ask Hakko or the designated contractor for repair.
- Do not disassemble or modify MONITOUCH. Otherwise, it may cause a malfunction.
- Hakko Electronics Co., Ltd. is not responsible for any damages resulting from repair, overhaul or modification of MONITOUCH that was performed by an unauthorized person.
- Do not use a sharp-pointed tool when pressing a touch switch. Doing so may damage the screen.
- Only experts are authorized to set up the unit, connect the cables or perform maintenance and inspection.
- For MONITOUCH using a lithium battery, handle the battery with care. The combustible materials such as lithium or organic solvent contained in the battery may generate heat, explode, or catch fire, resulting in personal injury or fire. Read related manuals carefully and handle the lithium battery correctly as instructed.
- When using a MONITOUCH that has analog switch resolution with resistance film, do not press two or more points on the screen at the same time. If there is a switch between the two pressed points, it may be activated.
- Take safety precautions during such operations as setting change during running, forced output, start, and stop. Any misoperation may cause unexpected machine motions, resulting in machine accident or damage.
- In facilities where a failure of MONITOUCH could lead to accident threatening human life or other serious damage, be sure that the facilities are equipped with adequate safeguards.
- At the time of disposal, MONITOUCH must be treated as industrial waste.
- Before touching MONITOUCH, discharge static electricity from your body by touching grounded metal. Excessive static electricity may cause malfunction or trouble.

[General Notes]

- Never bundle control cables and input/output cables with high-voltage and large-current carrying cables such as power supply cables. Keep these cables at least 200 mm away from the high-voltage and large-current carrying cables. Otherwise, malfunction may occur due to noise.
- When using MONITOUCH in an environment where a source of high-frequency noise is present, it is recommended that the FG shielded cable (communication cable) be grounded at its ends. However, the cable may be grounded only at one end if this is necessary due to unstable communication conditions or for any other reason.
- Plug connectors or sockets of MONITOUCH in the correct orientation. Otherwise, it may cause a malfunction.
- Do not use thinners for cleaning because they may discolor the MONITOUCH surface. Use alcohol or benzine commercially available.
- If a data receive error occurs when MONITOUCH and the counterpart (PLC, temperature controller, etc.) are started at the same time, read the manual for the counterpart unit and handle the error correctly.
- Avoid discharging static electricity on the mounting panel of the MONITOUCH. Static charges can damage the unit and cause malfunctions. Otherwise, malfunction may occur due to noise.
- Avoid prolonged display of any fixed pattern. Due to the characteristics of the liquid crystal display, an afterimage may occur. If a prolonged display of a fixed pattern is expected, use the auto OFF function of the backlight.

Contents

Preface

Notes on Safe Use of MONITOUCH

Chapter 1 Overview

1. Features	1-1
2. Models and Peripheral Equipment	1-2
MONITOUCH Models	1-2
Peripheral Equipment	1-3
3. System Composition	1-7
System Composition of V7 Series (Standard)	1-7
System Composition of V7i (High-performance)	1-8

Chapter 2 Specifications

1. Specifications	2-1
General Specifications	2-1
Display Specifications	2-2
Touch Switch Specifications	2-2
Function Switch Specifications	2-2
Interface Specifications	2-3
Clock and Backup Memory Specifications	2-3
Drawing Environment	2-3
Display Function Specifications	2-4
Function Performance Specifications	2-5
2. Dimensions and Panel Cut-out	2-6
V708/V708i External View and Dimensions	2-6
V710/V710i External View and Dimensions	2-7
V712/V712i External View and Dimensions	2-8
3. Names and Functions of Components	2-9
4. Serial Connector (CN1)	2-12
Serial Connector for PLC Connection	2-12
5. Modular Jack (MJ1/MJ2)	2-13
Modular Jack 1 (MJ1)/2 (MJ2)	2-13
V-SFT Setting	2-13
Transferring Screen Data	2-15
Barcode Reader Connection	2-15
6. LAN Connector (LAN)	2-16
LAN Connector	2-16
Wiring	2-17
7. CF Card (CF)	2-18
Recommended CF Cards	2-18
Mounting and Dismounting the CF Card	2-18
Notes on Handling the CF Card	2-19
8. Printer Connection (PRINTER)	2-20
Printer Connector (PRINTER)	2-20
Connection with Printer through Serial Interface	2-21

Chapter 3 Installation

1. Mounting Procedure	3-1
Mounting Procedure	3-1
Mounting Angle	3-1

2. Power Supply Cable Connection	3-2
Power Supply Cable Connection	3-2
Notes on Usage of 100-240 VAC Specifications	3-3
Grounding	3-3

Chapter 4 Instructions

1. Coin-type Lithium Battery	4-1
Battery Mounting Procedure	4-1
Battery Replacement	4-2
2. DIP Switch Setting	4-4
DIP Switch (DIPSW) Setting	4-4
3. Function Switches	4-5
Types	4-5
[SYSTEM] Switch	4-5

Chapter 5 Connections

1. 1 : 1 Connection	5-1
2. 1 : n Connection (Multi-drop)	5-2
3. n : 1 Connection (Multi-link 2)	5-3
4. n : 1 Connection (Multi-link)	5-4
5. Universal Serial Communications	5-5
6. V-Link	5-6
7. PLC2Way	5-7
8. Temperature Control Network	5-8
9. Ethernet	5-9
10. Other Networks	5-11
FL-net (OPCN-2)	5-11
MELSECNET/10	5-12
CC-Link	5-14
OPCN-1	5-15
T-LINK	5-16
PROFIBUS-DP	5-17
DeviceNet	5-18

Chapter 6 MONITOUCH Operations

1. Operational Procedures	6-1
MONITOUCH Operation	6-1
2. Main Menu Screen	6-3
1. I/O Test	6-4
1-1. Self-loop Test	6-5
1-2. Print Check	6-8
1-3. SYSTEM & Function Switch Test	6-8
1-4. Touch Switch Test	6-9
2. Card Menu Screen	6-11
2-1. CREC Menu Screen	6-12
2-2. Transferring Screen Data from a CF Card	6-14
2-3. Saving Backup Copies of SRAM	6-20
2-4. Messages during Data Transfer	6-22
3. Ethernet	6-23

4. SRAM/Clock.....	6-26
5. Extension Program Information	6-27
6. Extended Function Setting.....	6-28

Chapter 7 Error Correction

1. Error Message	7-1
1. Communication Error	7-1
2. Check.....	7-5
3. Warning.....	7-5
4. SYSTEM ERROR	7-6
5. Touch Switch is Active	7-6
2. Troubleshooting	7-7
In the Event of an Error.....	7-7
Probable Symptoms.....	7-7

Chapter 8 Inspection and Maintenance

1. Inspection and Maintenance	8-1
Daily Inspection.....	8-1
Periodical Inspection.....	8-1
2. Warranty Policy.....	8-2
Inquiries about Failure.....	8-2
Warranty Period	8-2
Free-of-charge Repair	8-2
Chargeable Repair	8-2
Inquiry Form.....	8-3

1

Overview

1. Features
2. Models and Peripheral Equipment
3. System Composition

1. Features

The V7 series inherits and heightens the features of the V6 series as described below.

1. 32k-color Display
32,768-color display makes colorful expression possible.
Bitmap files are clearly displayed in brilliant colors.
2. CF Card Interface as Standard
The CF card can be used for saving multiple screen data, sampling data, recipe data, hard copy images, and other various usages.
Large-sized video capture images, JPEG or WAV files can be saved.
3. Connector for LAN (for high-performance type only)
This connector enables Ethernet connection with a host computer. 100BASE-TX/10BASE-T is supported. High-speed communications are possible via Ethernet for uploading/downloading screen data and reading/writing data from/to the server.
4. Video Display Upgraded (for high-performance type only/optional)
The video display function is upgraded drastically to allow: saving the current video screen, taking snapshots of multiple exposures, superimposing a semi-transparent operation screen on a video display, showing four video channels at the same time, and so on.
5. Web Server Function (for high-performance type only)
The V7i screens are converted into HTML files and displayed on the WWW browser using the Ethernet.
6. Animation Function
The animation function enables representation of the field close to the real image.
7. Play of WAV File (for high-performance type only/optional)
WAV files can be played with ease simply by connecting the option unit to the speaker.
It is possible to use sound for notifying the field conditions, such as an occurrence of an error. So, the monitoring operator can work in a distance.

2. Models and Peripheral Equipment

MONITOUCH Models

The model name consists of the following information.

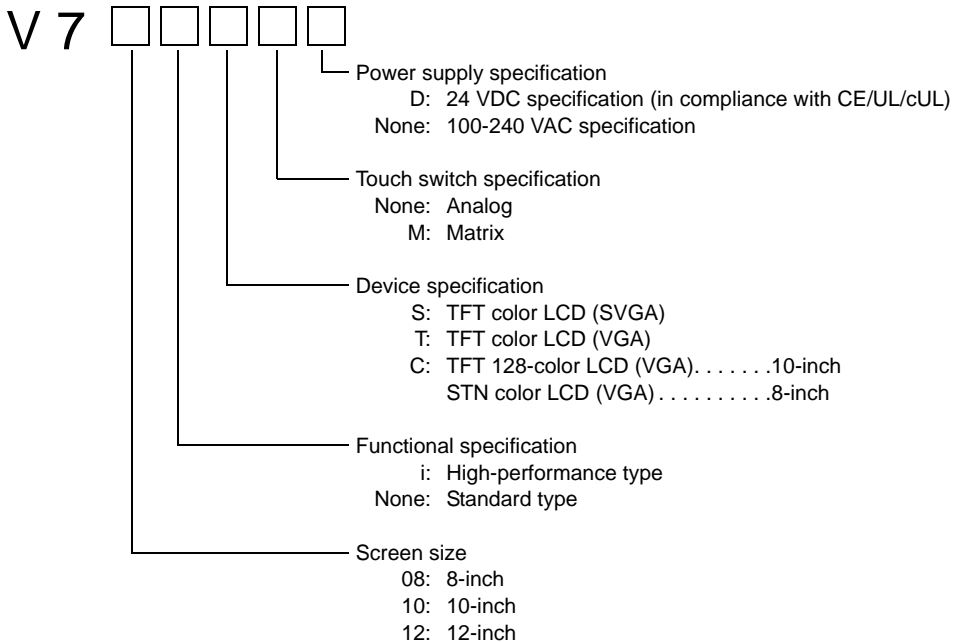

The following models are available.

<Analog>

Series and Size	Model Name	Specifications	Remarks
V708 series 8-inch	V708SD	TFT color, 800 × 600 dots, standard, DC power supply	Compliant with CE/UL/cUL
	V708iSD	TFT color, 800 × 600 dots, high-performance, DC power supply	Compliant with CE/UL/cUL
	V708CD	STN color, 640 × 480 dots, standard, DC power supply	Compliant with CE/UL/cUL
V710 series 10-inch	V710T	TFT color, 640 × 480 dots, standard, AC power supply	
	V710TD	TFT color, 640 × 480 dots, standard, DC power supply	Compliant with CE/UL/cUL
	V710iT	TFT color, 640 × 480 dots, high-performance, AC power supply	
	V710iT	TFT color, 640 × 480 dots, high-performance, DC power supply	Compliant with CE/UL/cUL
	V710S	TFT color, 800 × 600 dots, standard, AC power supply	
	V710SD	TFT color, 800 × 600 dots, standard, DC power supply	Compliant with CE/UL/cUL
	V710iS	TFT color, 800 × 600 dots, high-performance, AC power supply	
	V710iSD	TFT color, 800 × 600 dots, high-performance, DC power supply	Compliant with CE/UL/cUL
	V710C	TFT color, 640 × 480 dots, standard, AC power supply	
	V710CD	TFT color, 640 × 480 dots, standard, DC power supply	Compliant with CE/UL/cUL

Series and Size	Model Name	Specifications	Remarks
V712 series 12-inch	V712S	TFT color, 800 × 600 dots, standard, AC power supply	
	V712SD	TFT color, 800 × 600 dots, standard, DC power supply	Compliant with CE/UL/cUL
	V712iS	TFT color, 800 × 600 dots, high-performance, AC power supply	
	V712iSD	TFT color, 800 × 600 dots, high-performance, DC power supply	Compliant with CE/UL/cUL

<Matrix>

Series and Size	Model Name	Specifications	Remarks
V710 series 10-inch	V710TM	TFT color, 640 × 480 dots, standard, AC power supply	
	V710TMD	TFT color, 640 × 480 dots, standard, DC power supply	Compliant with CE/UL/cUL
	V710iTM	TFT color, 640 × 480 dots, high-performance, AC power supply	
	V710iTMD	TFT color, 640 × 480 dots, high-performance, DC power supply	Compliant with CE/UL/cUL
	V710CM	TFT color, 640 × 480 dots, standard, AC power supply	
	V710CMD	TFT color, 640 × 480 dots, standard, DC power supply	Compliant with CE/UL/cUL
V712 series 12-inch	V712SM	TFT color, 800 × 600 dots, standard, AC power supply	
	V712SMD	TFT color, 800 × 600 dots, standard, DC power supply	Compliant with CE/UL/cUL
	V712iSM	TFT color, 800 × 600 dots, high-performance, AC power supply	
	V712iSMD	TFT color, 800 × 600 dots, high-performance, DC power supply	Compliant with CE/UL/cUL

Peripheral Equipment

The following options are available for using the V7 series more effectively.

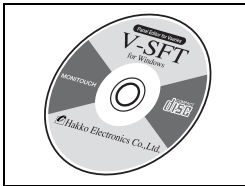

V-SFT (configuration software: English version)

Application software for editing display data for the MONITOUCH.
(Windows98/NT4.0/Me/2000/XP compatible)
The V7 series is supported with ver. 2.00 and later.

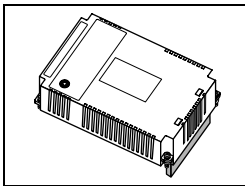

EU-xx (option unit)

* This option unit can only be mounted on the V7i model.

xx: 00 → Video input + sound output unit

Video images can be displayed on V7i directly.
WAV files can be played at an external speaker.

xx: 01 → RGB input + sound output unit

Screen images displayed on a CRT display can be shown on V7i.
WAV files can be played at an external speaker.

xx: 02 → RGB output + sound output unit

Screen images displayed on V7i can be shown on a CRT display.
WAV files can be played at an external speaker.

xx: 03 → Sound output unit

WAV files can be played at an external speaker.

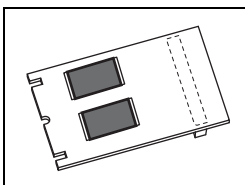

V7EM-F (FLASH memory cassette)

Extension print circuit board to extend the memory for screen data.
The capacity of FLASH memory is 8 Mbyte.

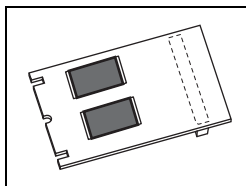
**V7EM-L (FLASH memory cassette for ladder monitor)**

Extension print circuit board for the ladder monitor function.
The memory for screen data is extended at the same time.
The capacity of FLASH memory is 8 Mbytes. (4 Mbytes for ladder monitor, 4 Mbytes for screen data)

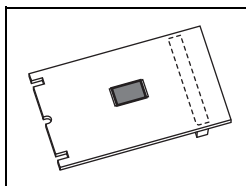
**V7EM-S (SRAM cassette)**

Extension print circuit board to back-up the memory for sampling data, V7 internal memory and memo pad. The capacity of an SRAM cassette is 512 kbyte.

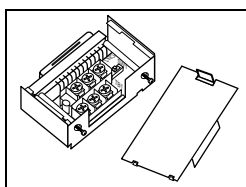
**TC485 (terminal converter)**

Used for connection between the V7 series and a PLC at the RS-422/485 terminal block.

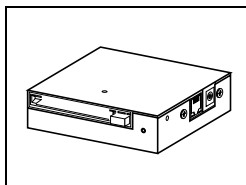
**CREC (card recorder)**

The card recorder creates a backup copy of screen data or works as an external memory storage system for memory manager and data logging functions.

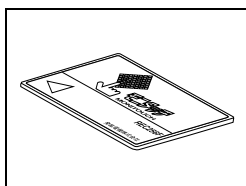
**REC-MCARD (memory card) compliant with JEIDA ver. 4.0**

Used with the card recorder when having a backup copy of screen data or saving data on an external medium for memory manager and data logging functions.

SRAM 256 k, 512 k, 1 M, 2 M, 4 Mbyte
FLASH ROM 256 k, 512 k, 1 Mbyte

**M-CARD SFT (memory card editor)**

Application software for editing data stored on a memory card, SRAM or CF card.
(Windows98/NT4.0/Me/2000/XP compatible)

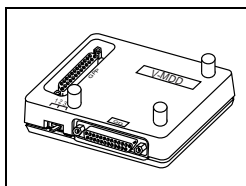
**V-MDD (ACPU/QnACPU/FXCPU dual port interface)**

Add-on connector with two ports, specifically designed for the connector on the MITSUBISHI's ACPUCPU/QnACPU/FXCPU programmer. Operability can be improved when directly connecting the V7 series to the ACPUCPU/QnACPU/FXCPU programmer.

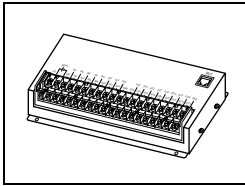
**V-I/O (serial extension I/O)**

Used as an external I/O unit for PLC. It has 16 inputs and 16 outputs.

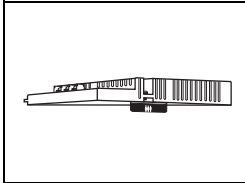

**CU-xx [xx: 00 → OPCN-1, 01 → T-LINK, 02 → CC-Link,
03-2 → Ethernet/FL-net (OPCN-2), 04 → PROFIBUS-DP,
05 → MELSECNET/10, 07 DeviceNet] (communication
interface unit)**

Used for communications with each network. This unit enables connection of multiple V7 series to a single PLC. Since other devices on the same network can be connected, it brings about the reduction in costs of the whole system.

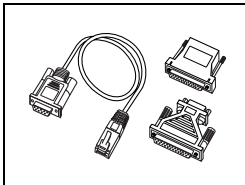
**V6-CP (screen data transfer cable) 3 m**

Used for connection between the V7 series and a personal computer, or a personal computer and the card recorder (CREC).

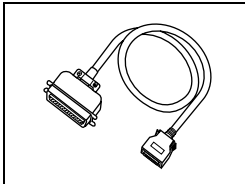
**V7-PT (printer cable) 2.5 m**

Used for connection between the V7 series and a printer.
For the CBM292/293 printer, use the V7-PTCBM printer cable (2.5 m).

**V6-BCD (barcode reader connection cable) 3 m**

Used for connection between the V7 series and a barcode reader.

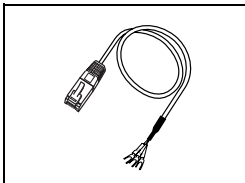
**V6-MLT (multi-link 2 master cable) 3 m**

Used for Multi-Link 2 connection between the V7 master station and the V7 slave station.

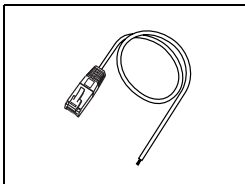
**V6-TMP (temperature controller connection cable)**

Used for connection between the V7 series and a temperature controller or a PLC via PLC2Way.

V6-TMP : 3m
V6-TMP-5M : 5m
V6-TMP-10M : 10m

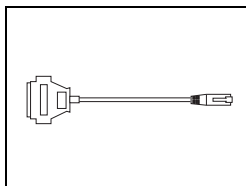

MJ-D25 (MJ-to-D-sub conversion cable) 0.3 m

Used for connection between the V7 series and a PLC via PLC2Way.

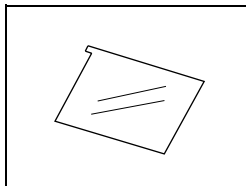
V7xx-GS [xx: 08 → V708/V708i, 10 → V710/V710i, 12 → V712/V712i]
(protective sheet)

This sheet protects the operation panel surface. (5 sheets/set)

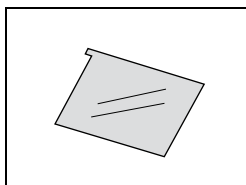
V7xx-GSN10 [xx: 08 → V708/V708i, 10 → V710/V710i, 12 → V712/V712i]
(protective sheet)

This anti-glare sheet protects the operation panel surface. (5 sheets/set)

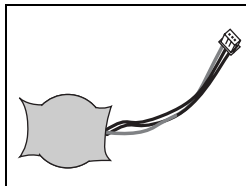

V7-BT (battery for replacement)

Replacement lithium battery for the V7 series.

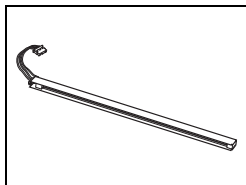

V712S-FL* → V712S/V712iS
 V612S-FL01* → V712S/V712iS
 V610S-FL01 → V710S/V710iS
 V710T-FL* → V710T/V710iT
 V610T-FL01* → V710T/V710iT/V710C
 V708S-FL → V708S/V708iS
 V608C-FL → V708C
 (backlight for replacement)

Replacement backlight parts for the V7 series.

* The type of backlight depends on the serial number of the V7 series. For more information, please ask your local distributor.

3. System Composition

System Composition of V7 Series (Standard)

The following illustration shows possible system configurations using the V7 series (standard).

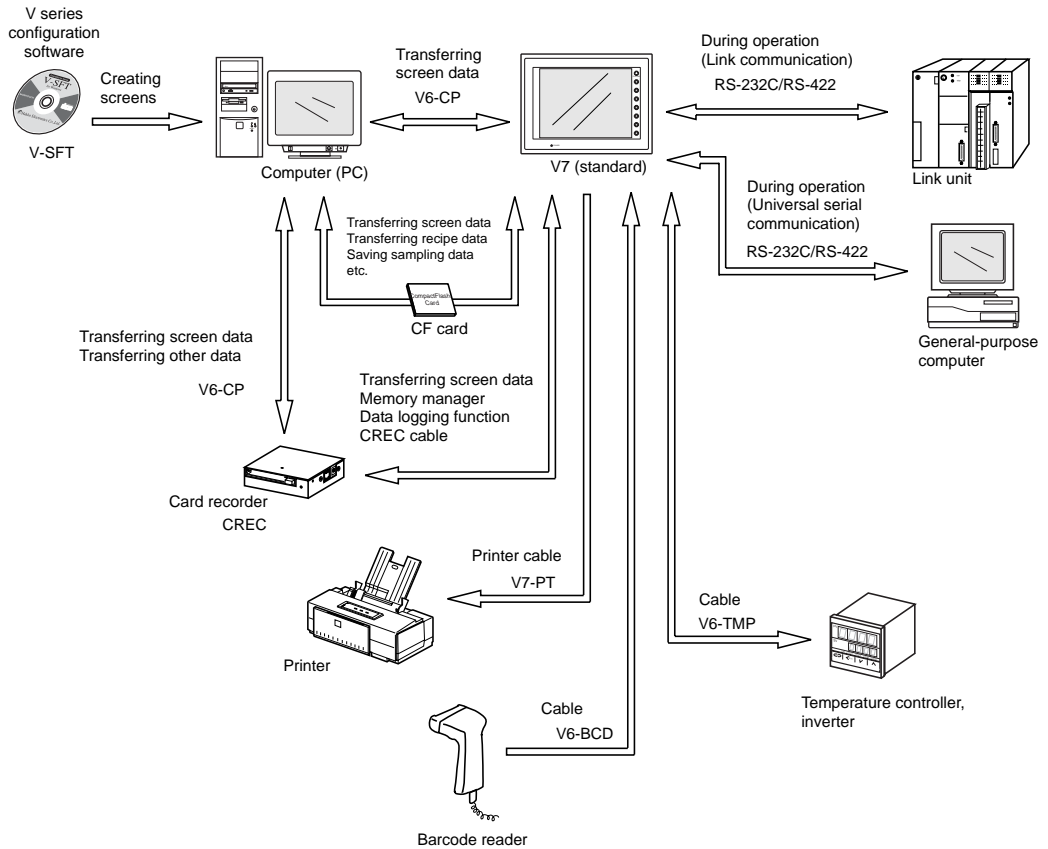

System Composition of V7i (High-performance)

The following illustration shows possible system configurations using the V7i series (high-performance).

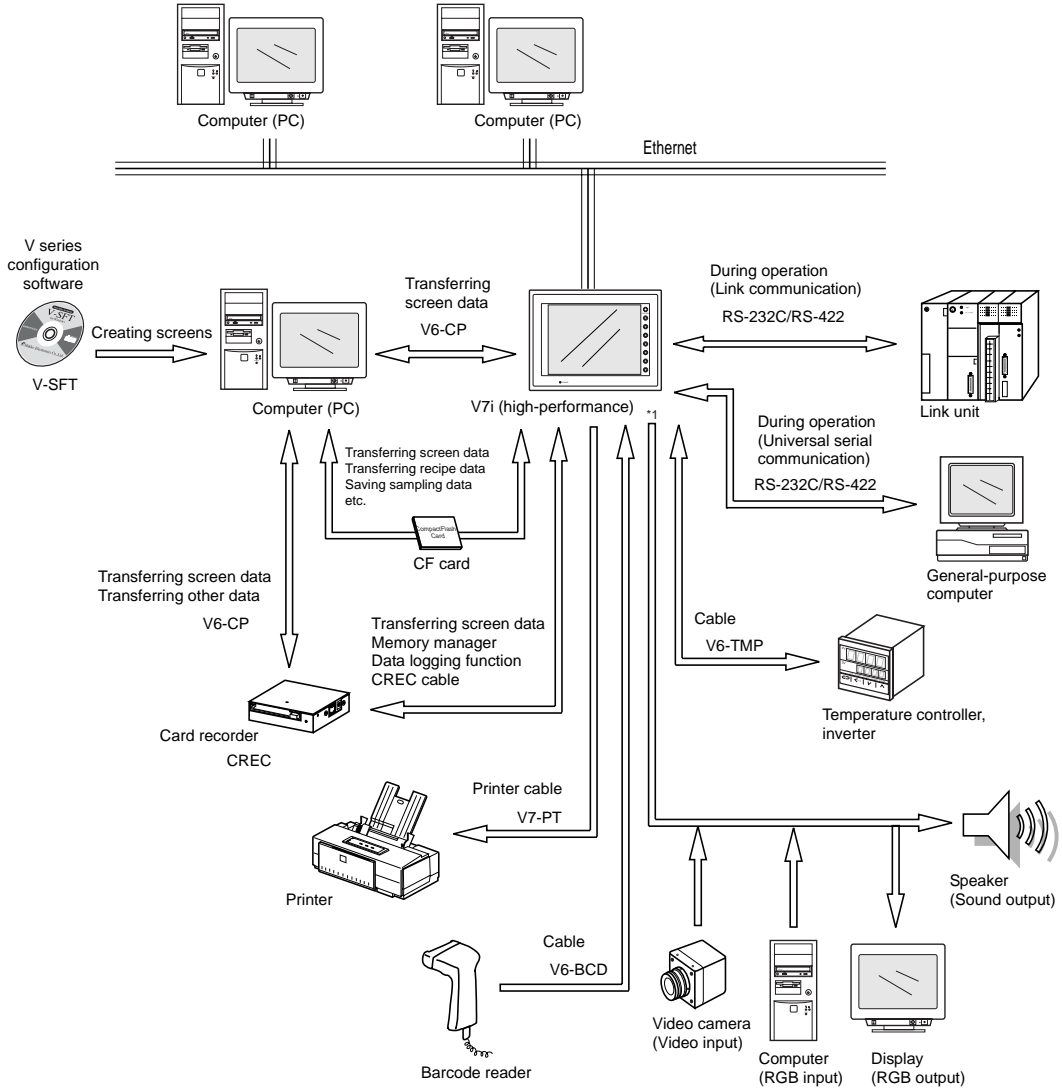

*1 The option unit (EU-xx) is required.

2 Specifications

1. Specifications
2. Dimensions and Panel Cut-out
3. Names and Functions of Components
4. Serial Connector (CN1)
5. Modular Jack (MJ1/MJ2)
6. LAN Connector (LAN)
7. CF Card (CF)
8. Printer Connection (PRINTER)

1. Specifications

General Specifications

Item		Model					
		V708		V710		V712	
		DC power supply		AC power supply	DC power supply	AC power supply	DC power supply
Power Supply	Rated Voltage	24 VDC		100 - 240 VAC	24 VDC	100 - 240 VAC	24 VDC
	Permissible Range of Voltage	24 VDC \pm 10%		100 - 240 VAC \pm 10%	24 VDC \pm 10%	100 - 240 VAC \pm 10%	24 VDC \pm 10%
	Permissible Momentary Power Failure	Within 1 ms		Within 20 ms	Within 1 ms	Within 20 ms	Within 1 ms
	Power Consumption (Maximum Rating)	V708C 15 W or less	V708S/S 22 W or less	60 VA or less	30 W or less	60 VA or less	30 W or less
	Rush Current	25 A, 0.7 ms		For 100 VAC: 16 A, 6 ms For 200 VAC: 32 A, 7 ms	30 A, 1ms	For 100 VAC: 16 A, 6 ms For 200 VAC: 32 A, 7 ms	30 A, 1 ms
	Withstand Voltage	DC external terminals to FG: 500 VAC, 1 minute		AC external terminals to FG: 1500 VAC, 1 minute	DC external terminals to FG: 500 VAC, 1 minute	AC external terminals to FG: 1500 VAC, 1 minute	DC external terminals to FG: 500 VAC, 1 minute
Insulation Resistance		500 VDC, 10 M Ω or above					
Physical Environment	Ambient Temperature	0°C to +50°C					
	Storage Ambient Temperature	-10°C to +60°C					
	Ambient Humidity	85% RH or less (without dew condensation)					
	Solvent Resistance	No cutting oil or organic solvent attached to the unit					
	Atmosphere	No corrosive gas, not so much excessive dust and no conductive dust					
Mechanical Working Conditions	Vibration Resistance	Vibration frequency: 10 to 150 Hz, Acceleration: 9.8 m/s ² (1.0G) Single amplitude: 0.075 mm, X, Y, Z: 3 directions for one hour					
	Shock Resistance	Pulse shape: Sine half wave Peak acceleration: 147 m/s ² (15G), X, Y, Z: 3 directions six times each					
Electrical Working Conditions	Noise Resistance	1500 Vp-p (pulse width 1 μ s, rise time: 1 ns)					
	Static Electricity Discharge Resistance	Compliant with IEC61000-4-2, contact: 6 kV, air: 8 kV					
Mounting Conditions	Grounding	Grounding resistance: less than 100 Ω					
	Structure	Protection structure: front panel: compliant with IP65 (when using waterproof gasket) rear case: compliant with IP20 Form: in a single body Mounting procedure: inserted in a mounting panel					
	Cooling System	Cooling naturally					
	Weight (kg)	Unit: approx. 1.5	Analog type: Unit: approx. 2.4 Matrix type: Unit: approx. 2.8	Analog type: Unit: approx. 2.7 Matrix type: Unit: approx. 3.2			
	Dimensions W x H x D (mm)	233 x 178 x 66.1		303.8 x 231.0 x 72.0		326.4 x 259.6 x 72.0	
	Panel Cut-out (mm)	220.5 ^{+0.5} x 165.5 ^{+0.5}		289.0 ^{+0.5} x 216.2 ^{+0.5}		313.0 ^{+0.5} x 246.2 ^{+0.5}	
Case Color	Black (Munsell N2.0)						
Material	PC/ABS*						

* The material is different according to the hardware version of each type of MONITOUCH as follows.

Type Material	V708C	V708S	V710C	V710T/S, V712
PC/PS	a to d	a to e	a to d	a to f
PC/ABS	f or later	f or later	e or later	g or later

Display Specifications

Item	Model					
	V708C	V708xS	V710C	V710xT	V710xS	V712xS
Display Device	STN color LCD	TFT color LCD				
Display Size	7.7-inch	8.4-inch	10.4-inch			12.1-inch
Colors	128 colors +16-color blinks	32,768 colors +16-color blinks	128 colors +16-color blinks	32,768 colors +16-color blinks		
Resolution W × H (dots)	640 × 480	800 × 600	640 × 480		800 × 600	
Dot Pitch W × H (mm)	0.246 × 0.246	0.213 × 0.213	0.33 × 0.33		0.264 × 0.264	0.3075 × 0.3075
Brightness (cd/m ²)	200	350	220	350	280	350
Contrast Ratio	25 : 1	250 : 1	350 : 1	300 : 1	300 : 1	350 : 1
Angle of Vertical Visibility (°)	+40, -30	+35, -55	+30, -20	+45, -55	+35, -45	+40, -45
Angle of Horizontal Visibility (°)	±50	±50	±45	±70	±50	±55
Backlight	Cold cathode rectifier (exchangeable by users)					
Average Backlight Life*1	Approx. 40,000 h	Approx. 50,000 h				
Backlight Auto OFF Function	Always ON, random setting					
Contrast Adjustment	Provided *2	Not provided				
Brightness Adjustment	Not provided	3 levels *2				
Surface Sheet	Material: Polycarbonate, 0.3 mm thick					
POWER Lamp	ON when the power is supplied					

*1 When the normal temperature is 25°C, and the surface luminance of the display is 50% of the initial setting.

*2 Adjustable with function switches

Touch Switch Specifications

Item	Specifications	
Method	Analog resistance film type	Matrix resistance film type
Switch Resolution	1024 (W) × 1024 (H)	10.4-inch: 40 (W) × 24 (H)
		12.1-inch: 50 (W) × 30 (H)
Mechanical Life	One million activations or more	
Surface Treatment	Hard-coated, anti-glare treatment 5%	

Function Switch Specifications

Item	Specifications
Number of Switches	8
Method	Digital resistance film type
Mechanical Life	One million activations or more

Interface Specifications

Item	Specifications
Serial Interface for PLC Connection (D-sub 25-pin, female)	RS-232C, RS-422/485 Asynchronous type Data length: 7, 8 bits Parity: Even, odd, none Stop bit: 1, 2 bits Baud Rate: 4800, 9600, 19200, 38400, 57600, 76800, 115k bps
Serial Interface 1, 2 for Screen Data Transfer/External Connection (Modular jack, 8-pin)	RS-232C, RS-422/485 (2-wire connection) CREC, Barcode, V-I/O, Multi-link 2, Temperature control network/PLC2Way, V-link, etc.
Printer Interface for Printer Connection	Compliant with Centronics, half-pitch 36-pin PR201, ESC/P-J84, ESC/P super function, ESC/P24-J84 CBM292/293 printer*1 Barcode printer MR400 EPSON printer: STYLUS PHOTO series*2
CF Card Interface	Compliant with CompactFlash™
Ethernet Connection 100BASE-TX ³ /10BASE-T (Standard with V7i)	Compliant with IEEE802.3 Baud rate: 100 Mbps, 10 Mbps Cables: 100 Ω unshielded twist-pair, category 5, maximum length = 100 m

*1 The CBM292/293 printer cannot print screen hard copies.

*2 For more information, refer to V-SFT Additional Specifications.

*3 It is available with SYSTEM PROG. Ver. 1.470 (V-SFT Ver. 2.2.25.0) or later.

Clock and Backup Memory Specifications

Item	Specifications
Battery Specification	Coin-type lithium primary cell
Backup Memory	SRAM 64 kbyte
Backup Time Period	5 years (ambient temperature at 25°C)
Battery Voltage Drop Detection	Provided (internal memory allocated)
Calendar Accuracy	Monthly deviation ±90 sec (ambient temperature at 25°C)

Drawing Environment

Item	Specifications
Drawing Method	Exclusive configuration software
Drawing Tool	Name of exclusive configuration software: V-SFT (Ver. 2.00 and later) Personal computer: Pentium II 450 MHz or above recommended OS: Windows98/Me/NT Ver.4.0/2000/XP Capacity of hard disk required: Free space of approx. 460 Mbyte or more (For minimum installation: approx. 105 Mbyte) Display: Resolution 800 × 600 or above recommended

Display Function Specifications

Item		Specifications				
Display Language*		USEnglish	English/Western Europe	Chinese (traditional)	Chinese (simplified)	Korean
Characters	1/4-size, 1-byte	ANK code	Latin1	ASCII code	ASCII code	ASCII code
	2-byte 16-dot	JIS #1, 2 levels	–	Chinese (traditional)	Chinese (simplified)	Hangul (without Kanji)
	2-byte 32-dot	JIS #1 level	–	–	–	–
Character Size		1/4-size: 8 × 8 dots 1-byte: 8 × 16 dots 2-byte: 16 × 16 dots or 32 × 32 dots Enlarge: W: 1 to 8 times, H: 1 to 8 times				
Number of Displayable Characters		Resolution	640 × 480		800 × 600	
		1/4-size	80 characters × 60 lines		100 characters × 75 lines	
		1-byte	80 characters × 30 lines		100 characters × 37 lines	
		2-byte	40 characters × 30 lines		50 characters × 37 lines	
Characters Properties		Display properties: Normal, reverse, blink, bold, shadow Colors: 32,768 colors + blink 16 colors (V708C, V710C: 128 colors + blink 16 colors)				
Graphics		Lines: Circles: Others:	Line, continuous line, box, parallelogram, polygon Circle, arc, sector, ellipse, elliptical arc Tile patterns			
Graphic Properties		Line types: Tile patterns: Display properties: Colors: Color selection:	6 (thin, thick, dot, chain, broken, two-dot chain) 16 (incl. user-definable 8 patterns) Normal, reverse, blink 32,768 colors + blink 16 colors (V708C, V710C: 128 colors + blink 16 colors) Foreground, background, boundary (line)			

* In addition, the following fonts are available. For more information, refer to the Reference Manual (Operation) and the V-SFT Additional Specifications Manual.
 Gothic, English/Western Europe (HK Gothic), English/Western Europe (HK Times), Central Europe, Cyrillic, Greek, Turkish

Function Performance Specifications

Item		Specifications
Screens		Max. 1024
Screen Memory		Flash memory: Approx. 4,992 kbyte (varies depending on the font)
Switch		768 per screen
Switch Actions		Set, reset, momentary, alternate, to light (Possible to press a function switch and a switch on the display at the same time)
Lamps		Reverse, blink, exchange of graphics 768 per screen
Graphs		Pie, bar, panel meter and closed area graph: No limitation within 256 kbyte per screen ^{*1} Statistics and trend graphs: Max. 256 per layer ^{*2}
Data Setting	Numerical Data Display	No limitation within 256 kbyte per screen ^{*1}
	Character Display	No limitation within 256 kbyte per screen ^{*1}
	Message Display	Resolution: 640×480, max. 80 characters (1-byte) 800 × 600, max. 100 characters (1-byte) No limitation within 256 kbyte per screen ^{*1}
Sampling		Sampling display of buffer data (Constant sample, bit synchronize, bit sample, relay sample, alarm function)
Graphic Library		Max. 2560
Multi-Overlaps		Max. 1024
Data Blocks		Max. 1024
Messages		Max. 32768 lines
Patterns		Max. 1024
Macro Blocks		Max. 1024
Page Blocks		Max. 1024
Direct Blocks		Max. 1024
Screen Blocks		Max. 1024
Data Sheets		Max. 1024
Screen Library		Max. 1024
Animation (Frames)		Max. 1023
Temperature Control Network/PLC2Way Table		Max. 32
Time Display		Provided
Hard Copy		Provided
Buzzer		Provided, 2 sounds (short beep, long beep)
Auto OFF Function		Always ON, random setting
Self-diagnostic Function		Switch self-test function Communication parameter setting check function Communication check function

*1 The number of setting memory locations is limited to 1024 per screen.

*2 Layer: 4 per screen (base + 3 overlaps)

2. Dimensions and Panel Cut-out

V708/V708i External View and Dimensions

(Unit: mm)

- Side View

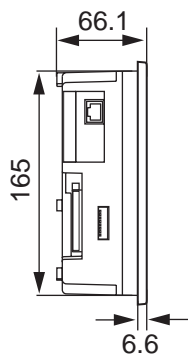

- Front View

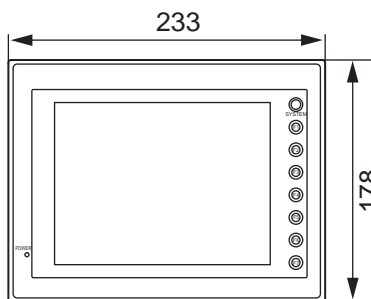

- Rear View

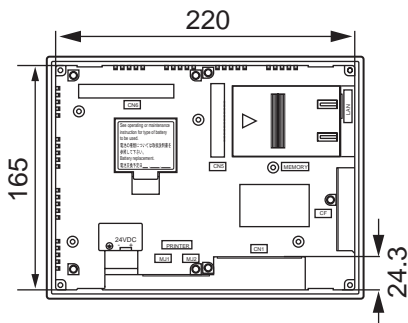

- Bottom View

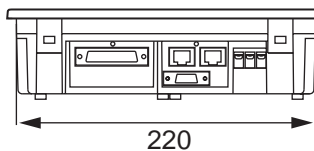

- Panel Cut-out Dimensions

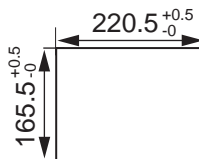

V710/V710i External View and Dimensions

(Unit: mm)

- Side View

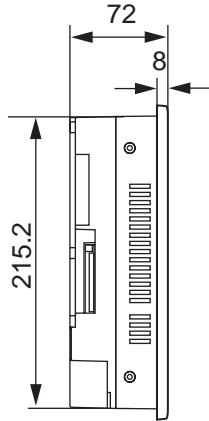

- Front View

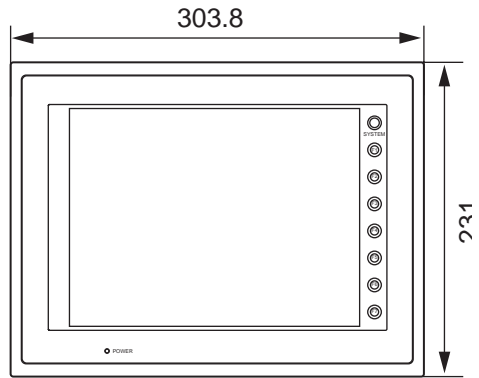

- Rear View

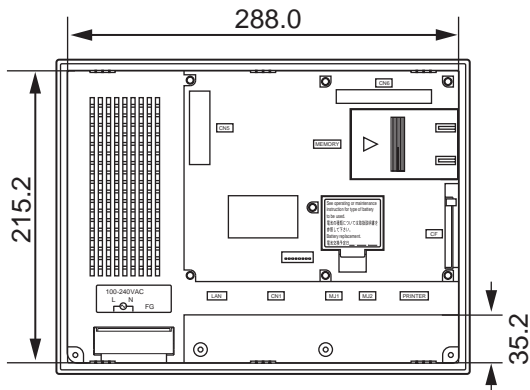

- Bottom View

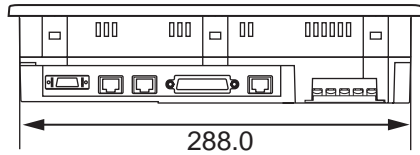

- Panel Cut-out Dimensions

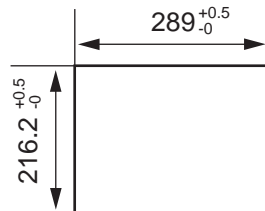

V712/V712i External View and Dimensions

(Unit: mm)

- Side View

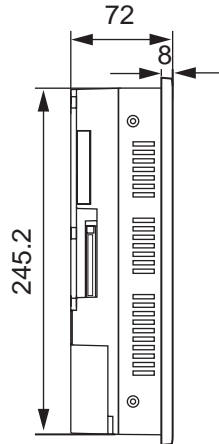

- Front View

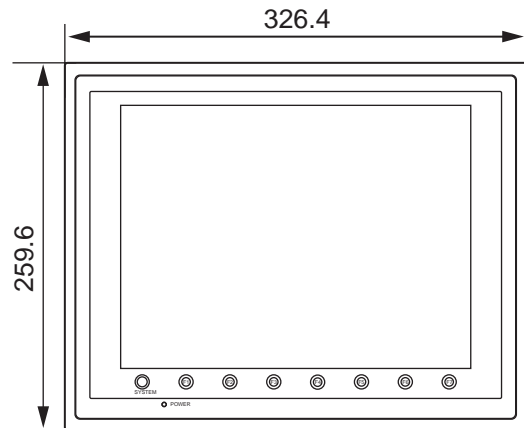

- Rear View

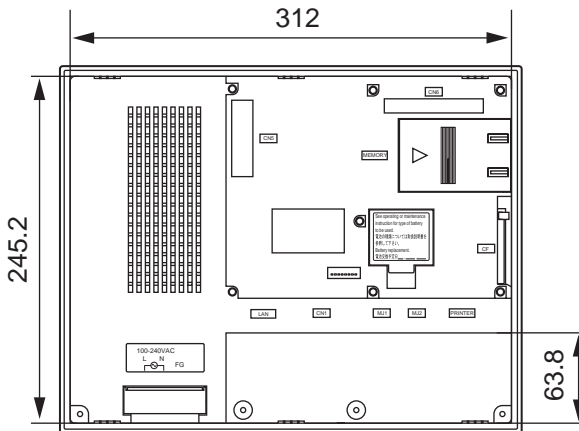

- Bottom View

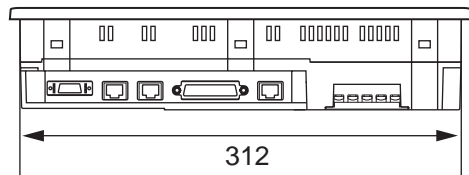

- Panel Cut-out Dimensions

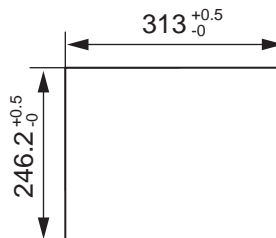

3. Names and Functions of Components

V708/V708i

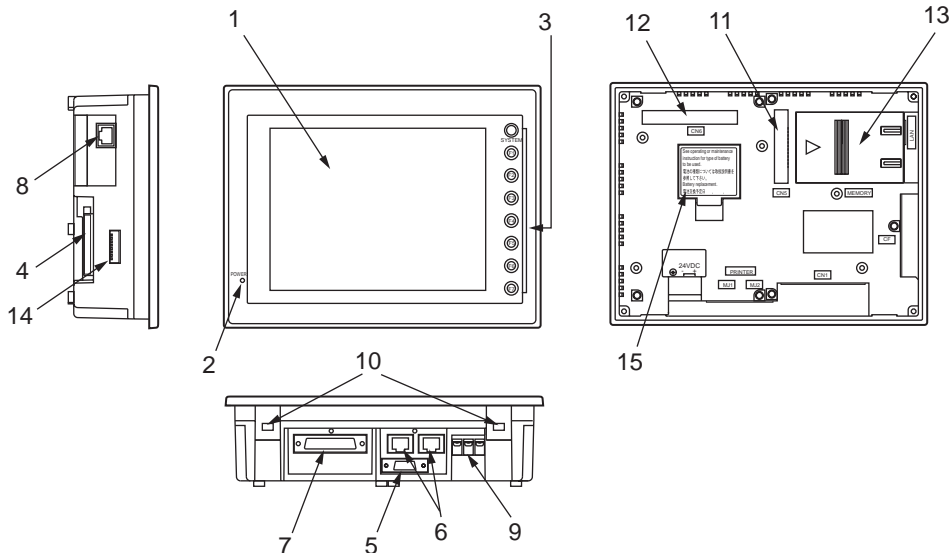

V710/V710i

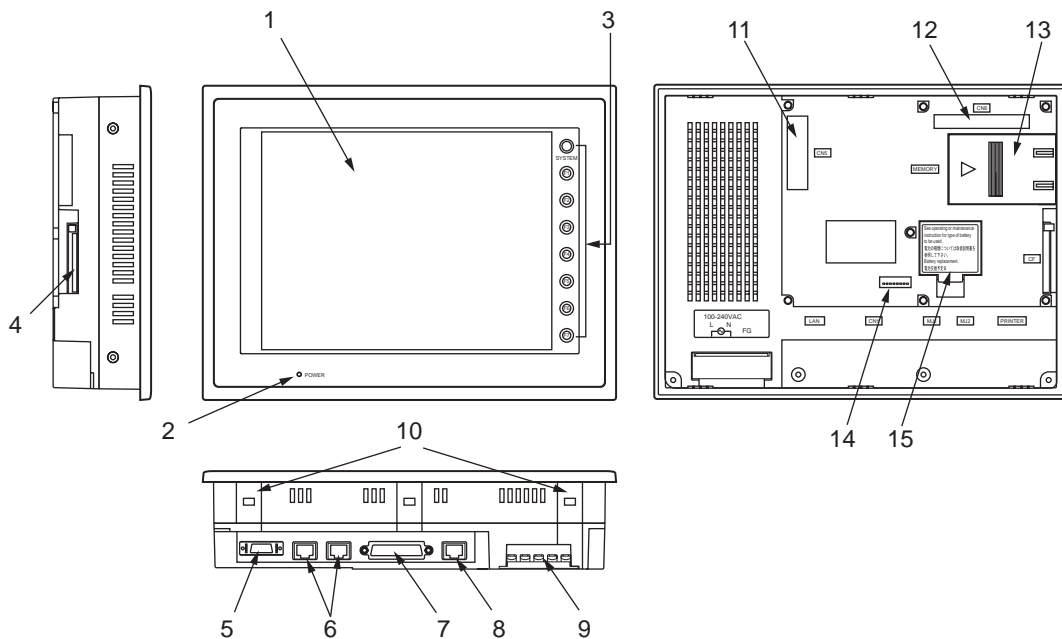

V712/V712i

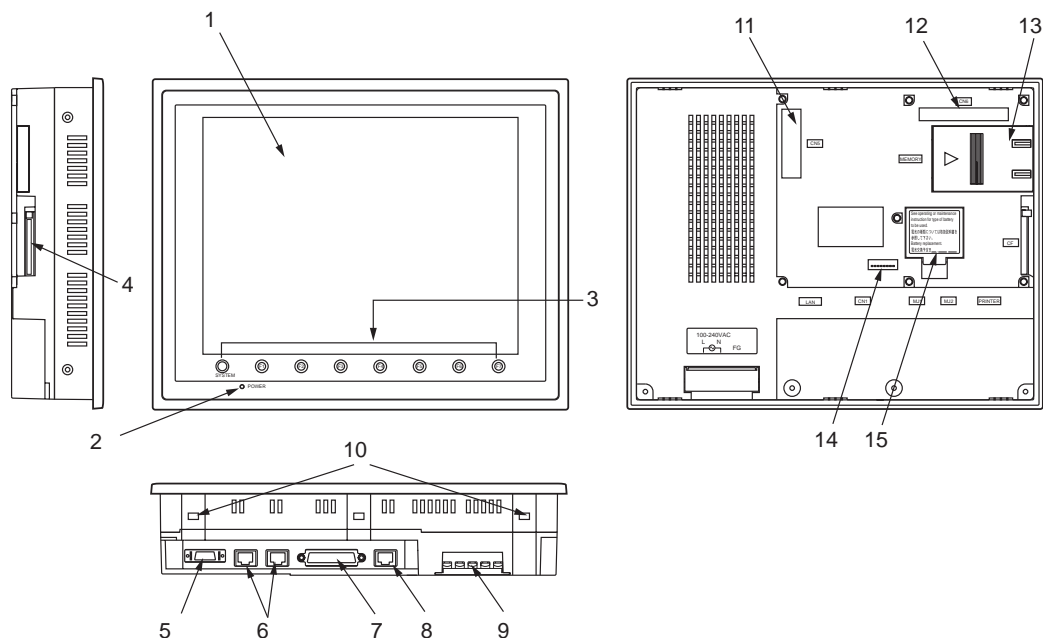

1. Display
This is the display unit.
2. Power lamp (POWER)
Illuminates (green) when the power is supplied to the V7 series.
3. Function switches
Used for RUN /STOP selection, contrast adjustment, brightness adjustment and backlight ON/OFF (according to the setting).
These switches can be used as user switches in the RUN mode.
4. CF card connector (CF)
This is the connector where the CF card is inserted.
5. Printer connector (PRINTER)
Used for printer connection.
6. Modular jack connectors (MJ1, MJ2)
Used for screen data transfer and connection with temperature controller, barcode reader, CREC, etc.
7. PLC communication connector (CN1)
Used for connection between the V7 series and a PLC or an external control unit (computer, custom controller, etc).
8. 100BASE-TX/10BASE-T connector (LAN) .. V7i only
Used for Ethernet connection.
9. Power supply terminal block
Supplies the power to the V7 series (100 to 240 VAC, 24 VDC)
10. Mounting holes
Used for inserting fixtures when securing the V7 series to the mounting panel.
11. Communication interface unit connector (CN5)
This is the connector where the communication unit (CU-xx, optional) for OPCN-1, T-LINK, CC-Link, Ethernet, FL-net (OPCN-2), PROFIBUS-DP, MELSECNET/10 or DeviceNet is mounted.

12. Option unit connector (CN6) V7i only
This is the connector where the option unit (EU-xx) for video, sound, RGB IN or RGB OUT is mounted.
13. Add-on memory connector (MEMORY)
This is the connector where the optional FLASH memory cassette (V7EM-F) or SRAM cassette (V7EM-S) is mounted.
14. DIP switch
8-bit DIP switch used for setting terminating resistance of the CN1 signal line and the MJ1/MJ2 RS-422/485 signal line.
15. Battery holder
Contains a backup battery for SRAM and clock.
When the battery voltage drops, replace the battery with a new one (V7-BT).

4. Serial Connector (CN1)

Serial Connector for PLC Connection

To communicate with the PLC (RS-232C, RS-422/485), connect the cable to the serial connector (CN1) at the bottom of the V7 unit.

- For V708/V708i:

Bottom View

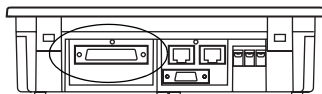

- For V710/V710i/V712/V712i:

Bottom View

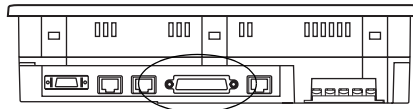

The serial connector pins correspond to signals as given below.

CN1 (D-sub 25-pin, female)	Pin No.	Signal Name	Contents
	1	FG	Frame ground
	2	SD	RS-232C send data
	3	RD	RS-232C receive data
	4	RS	RS-232C RS request to send
	5	CS	RS-232C CS clear to send
	6		Not used
	7	SG	Signal ground
	8		Not used
	9	+5 V	Use prohibited
	10	0 V	Use prohibited
	11		Not used
	12	+SD	RS-422 send data (+)
	13	-SD	RS-422 send data (-)
	14	+RS	RS-422 RS send data (+)
	15		Not used
	16		Not used
	17	-RS	RS-422 RS send data (-)
	18	-CS	RS-422 CS receive data (-)
	19	+CS	RS-422 CS receive data (+)
	20		Not used
	21	-	Use prohibited (V708: not used)
	22	-	Use prohibited (V708: not used)
	23		Not used
	24	+RD	RS-422 receive data (+)
	25	-RD	RS-422 receive data (-)

The following connector is recommended.

Recommended connector	DDK-make 17JE23250-02 (D8A)	D-sub 25-pin, male, metric thread (M2.6), with hood
-----------------------	-----------------------------	---

5. Modular Jack (MJ1/MJ2)

Modular Jack 1 (MJ1)/2 (MJ2)

This is a modular connector used for connection for screen data transfer, temperature controller, barcode reader, card recorder (CREC) or serial extension I/O (V-I/O).

- For V708/V708i:
- For V710/V710i/V712/V712i:

Bottom View

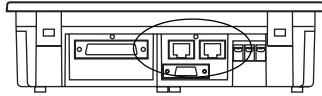

Bottom View

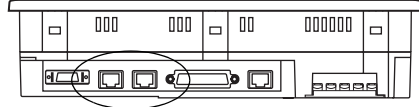

Pins of modular jacks 1 and 2 correspond to signals as given below.

MJ1/2	Pin No.	Signal Name	Contents
	1	+SD/RD	RS-485 + data
	2	-SD/RD	RS-485 - data
	3	+5 V	Externally supplied +5 V MAX 150 mA
	4	+5 V	
	5	SG	Signal ground
	6	SG	
	7	RD	RS-232C receive data
	8	SD	RS-232C send data

V-SFT Setting

1. The use of modular jacks 1 and 2 can be set on the V-SFT editor.
2. Select [Modular] from the [System Setting] menu. The [Modular Jack] dialog is displayed. Select the use of modular jacks 1 and 2 from the following options.

Modular Jack 1	Modular Jack 2
[Editor Port] ^{*1}	[Not Used]
[Card Recorder] ^{*2}	[Card Recorder] ^{*2}
[Barcode] ^{*3}	[Barcode] ^{*3}
[V-I/O] ^{*4}	[V-I/O] ^{*4}
[Multi-Link] ^{*5}	[Multi-Link] ^{*5}
[Temp./PLC2Way] ^{*6}	[Temp./PLC2Way] ^{*6}
[V-Link] ^{*7}	[V-Link] ^{*7}
[Touch Switch] ^{*8}	[Touch Switch] ^{*8}
[Ladder Tool] ^{*9}	[Ladder Tool] ^{*9}
[Modbus Slave] ^{*10}	[Modbus Slave] ^{*10}
[Printer (Serial Port)] ^{*11}	[Printer (Serial Port)] ^{*11}

*1 Refer to the next section "Transferring Screen Data".

*2 Select this option when connecting the card recorder (CREC).

*3 Refer to the next section "Barcode Reader Connection".

*4 Select this option when connecting the serial extension I/O (V-I/O).

*5 Select this open when "Multi-link 2" is selected for [Connection] and "1" is set for [Local Port] on the [Comm. Parameter] dialog.

*6 Select this option when connecting the temperature controller network or PLC2Way.

*7 Select this option for V-Link connection.

- *8 Refer to "EU-01 (RGB input + sound output unit)".
 *9 Select this option when using the ladder transfer function.
 *10 Select this option for Modbus slave connection.
 *11 Select this option when connecting the printer with serial interface.
 Refer to page 2-20.

Combination of MJ1 and MJ2 Functions

○ : Usable at the same time.

△ : Usable at the same time with V-SFT 2.0.2.0, SYSTEM PROG Ver. 1.010 and later

× : Not usable at the same time

MJ2 \ MJ1	Multi-Link 2	Card Recorder	Barcode	V-I/O	Temp./PLC 2Way	V-Link	Touch Switch	Ladder Tool	Modbus Slave	Printer (Serial Port)
Multi-Link 2		○	○	○	△	○	○	×	○	○
Card Recorder	○		○	○	○	○	○	○	○	○
Barcode	○	○		○	○	○	○	○	○	○
V-I/O	○	○	○		○	○	○	○	○	○
Temp./PLC 2Way	△	○	○	○		○	○	○	○	○
V-Link	○	○	○	○	○		○	○	×	○
Touch Switch	○	○	○	○	○	○		○	○	○
Ladder Tool	×	○	○	○	○	○	○		○	○
Modbus Slave	○	○	○	○	○	○	×	○		○
Printer (Serial Port)	○	○	○	○	○	○	○	○	○	

Supplemental Remark:

Multi-link communication and temperature control network/PLC2Way can be used at the same time.

Combination of Communication Unit (CU-xx) and Modular Jack Function

○ : Usable at the same time. × : Not usable at the same time

Communication Unit		MJ Multi-Link 2	Card Recorder, Barcode, V-I/O, Temp./PLC2Way, V-Link, Touch Switch, Modbus Slave, Printer (Serial Port)	Ladder Tool	Built-in Ethernet
CU-00	OPCN-1	×		×	○
CU-01	T-LINK	×		×	○
CU-02	CC-Link	×		×	○
CU-03(-2)	Ethernet	△ ^{*1}		×	×
CU-03(-2)	FL-net	×		×	×
CU-04	PROFIBUS-DP	×		×	○
CU-05	MELSECNET/10	×		×	○
CU-07	DeviceNet	×		×	○

*1 This is not possible when the V7 series and the PLC are connected via Ethernet.

Transferring Screen Data

- Use modular jack 1 (MJ1) when transferring screen data.
- When [Editor Port] is selected for [Modular Jack 1] on the V-SFT editor, it is possible to transfer data in the RUN mode because the RUN/STOP mode (on the Main Menu screen) can be automatically selected. Also RUN/STOP mode is automatically selected for on-line editing and simulation.
- When an option other than [Editor Port] is selected for [Modular Jack 1], select the STOP mode (on the Main Menu screen) and transfer screen data. Simulation or on-line editing is not available.
- When transferring screen data, use Hakko Electronics' data transfer cable (V6-CP) 3 m to connect the V7 series to a personal computer.

Barcode Reader Connection

- It is possible to receive the signal from a barcode reader by connecting the barcode reader at the modular jack (MJ1/2) of the V7 series.
- To connect a barcode reader to the modular jack (MJ1/2), use Hakko Electronics' optional cable (V6-BCD).
 - Length: 3 m
 - with modular plug
- Notes on connection
 - In the case of barcode readers with CTS and RTS control, it may be necessary to install a jumper to RTS and CTS. Otherwise the barcode reader may not work correctly.
 - The external power supply (+5 V) is max. 150 mA. (Refer to page 2-13.)
- When using the barcode reader that was connected to V4 (MONITOUCH's old version), connect it to the D-sub 9-pin female connector using the V6-BCD cable as shown below.

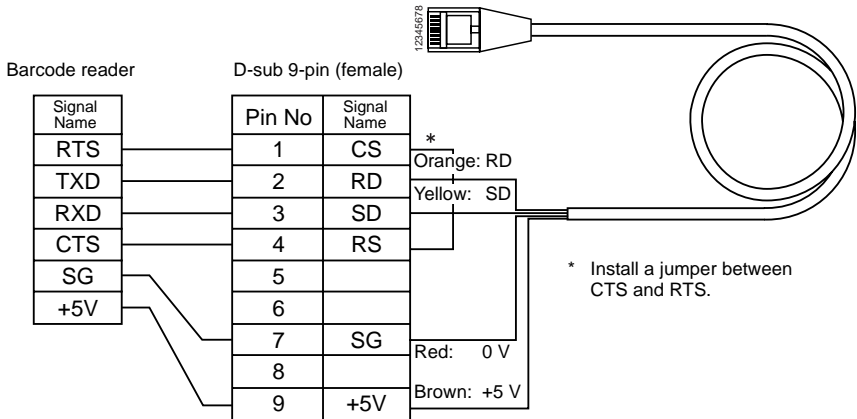
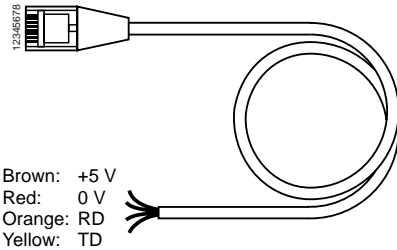

6. LAN Connector (LAN)

The connector for LAN is provided as standard on V7i (high-performance). 100BASE-TX*/10BASE-T is supported.

To connect Ethernet with V7 (standard), use the communication unit "CU-03(-2)".

If CU-03(-2) is attached to V7i, it has priority over the built-in LAN connector; LAN connector cannot be used.

* It is available with SYSTEM PROG. Ver. 1.470 (V-SFT Ver. 2.2.25.0) or later.

LAN Connector

Use this connector for Ethernet connection.

- For V708i:
- For V710i/V712i:

Side View

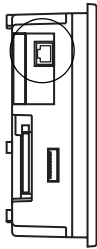

Bottom View

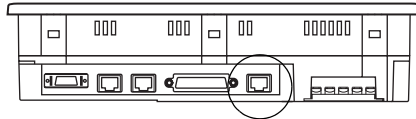

CAUTION

MJ1/2 and LAN connector are 8-pin modular jacks.

Check the name plate and insert the connector in the correct position.

The LAN pins correspond to signals as given below.

LAN	Pin No.	Signal Name	Contents
	1	TX+	Ethernet send signal (+)
	2	TX-	Ethernet send signal (-)
	3	RX+	Ethernet receive signal (+)
	4	NC	Not used
	5	NC	Not used
	6	RX-	Ethernet receive signal (-)
	7	NC	Not used
	8	NC	Not used

Wiring



CAUTION When using the LAN port, keep the LAN cable away from the power supply cable as much as possible.

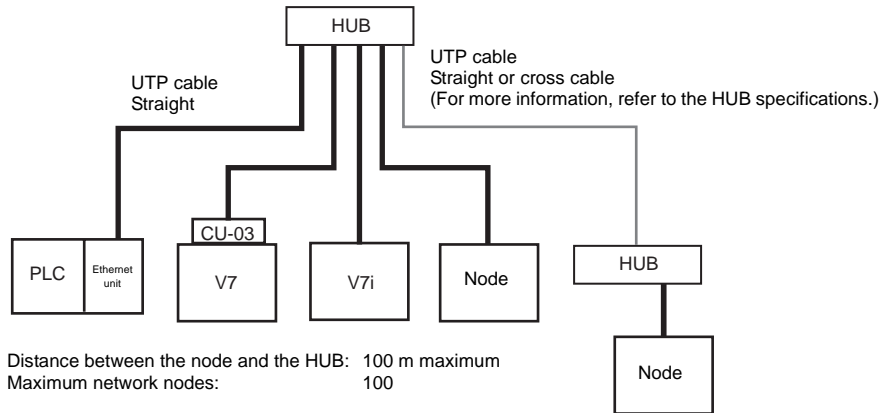

Cable Connection Diagram

Straight cable
(with HUB)

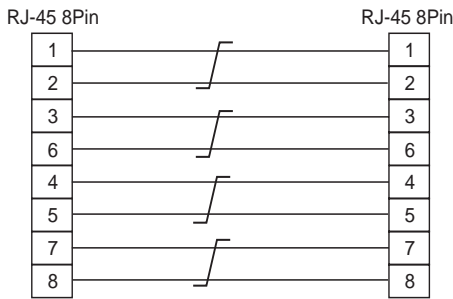

* Unshielded twist-pair cable

Cross cable
(without HUB)

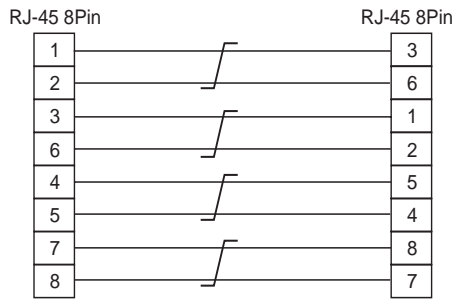

* Unshielded twist-pair cable

Recommended Cable

Use the following recommended cable.

Recommended cable	100BASE-TX/10BASE-T	Type: Twist-pair cable, category 5
-------------------	---------------------	------------------------------------

7. CF Card (CF)

Recommended CF Cards

CF cards in compliance with CompactFlash™ can be used.

The operation of the following cards has been verified by Hakko Electronics.

Manufacturer	Type	Capacity
SanDisk	SDCFB-64-J60	64 MB
	SDCFB-128-J60	128 MB
	SDCFB-256-J60	256 MB
	SDCFB-512-J60	512 MB
	SDCFB-1024-J60	1GB
I-O Data Device	CFS-32M(HI)	32 MB
	CFS-64M(HI)	64 MB
	CFS-128M(HI)	128 MB
	CFS-iV32	32 MB
	CFS-iV64	64 MB
	CFS-iV128	128 MB
	CFS-iV256	256 MB
	CFS-iV512	512 MB
	CFX-64M	64 MB

Mounting and Dismounting the CF Card

The CF card interface is provided on the side of the unit.

- For V708/V708i:

Side View

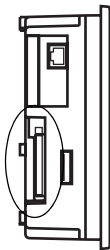

- For V710/V710i/V712/V712i:

Side View

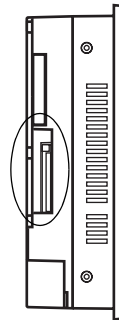

1. Insert the card securely into the interface with the card backside outwards viewed from the rear of the unit as shown below.

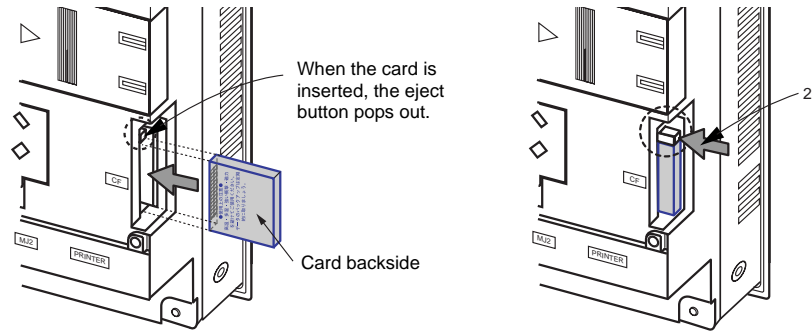

2. To remove the card, press the eject button. The card pops out.



Notes on Handling the CF Card

1. MONITOUCH can recognize a CF card in the FAT file system. It cannot recognize a FAT32-formatted CF card.
2. Do not insert or remove the CF card during access. Doing so may destroy data on the CF card. The CF card can be inserted or removed safely when the Main Menu screen is displayed. Before mounting or removing the CF card, be sure to check that the CF card is not being accessed. Doing so may destroy data on the CF card or cause CF card failure. However, if the [Card Menu] switch is pressed on the Main Menu screen and the CF card operation screen is displayed, it is not possible to insert or remove the CF card.
3. Do not turn the power off or on during access to the CF card.
4. Make a backup copy of the CF card at regular intervals.
5. If there should be a disk error and you cannot read/write data, you can scan the disk in Windows to restore the disk data. If not restored, initialize the CF card. Note that the data in the CF card will be completely deleted by initialization. (For more information on scanning the disk or operating Windows, refer to the Windows manual.)
6. The number of writing times per CF card is limited (approx. 300,000 times). Consequently, frequent writing at short intervals may shorten service life of the CF card. To use the CF card for saving sampling data, check the setting for sampling time. Also, avoid repeated writing using a CYCLE macro command.

8. Printer Connection (PRINTER)

When the V7 series is connected to a printer, a screen hard copy, data sheet or sampling data can be printed.

To connect a printer with parallel interface, insert the cable into the printer connector (PRINTER); to connect a printer with serial interface, insert the cable into a modular jack (MJ1/MJ2).



CAUTION

Be sure to turn the printer off when the V7 unit is turned off.

Printer Connector (PRINTER)

This is the printer connector for parallel interface.

- For V708/V708i:

Bottom View

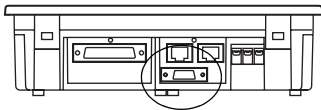

- For V710/V710i/V712/V712i:

Bottom View

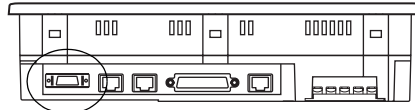

The printer interface pins correspond to signals as given below.

PRINT (half-pitch 20-pin)	Pin No.	Signal Name	Contents
	1	STB#	Strobe
	2	PD0	Data 0
	3	PD1	Data 1
	4	PD2	Data 2
	5	PD3	Data 3
	6	PD4	Data 4
	7	PD5	Data 5
	8	PD6	Data 6
	9	PD7	Data 7
	10	GND	
	11	BUSY#	Busy
	12	GND	
	13	SELECT	
	14	INTP#	INP PROME#
	15	PFAT#	FAULT#
	16	GND	
	17	GND	
	18	P+5V	PRN+5
	19	GND	
	20	GND	

Connecting Cable

- To connect the V7 series to a printer, use Hakko Electronics' printer cable "V7-PT" 2.5 m for 20-pin parallel interface.
For the CBM292/293 printer, use the V7-PTCBM printer cable (2.5 m).

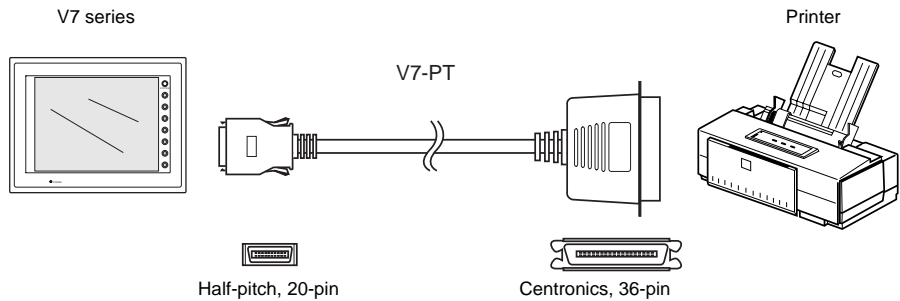

Compatible Printer Models

Control code system:

- PR201
- ESC-P

PC-PR201 series compatible with MS-DOS computer
ESC/P24-J84, ESC/P-J84, ESC/P super function compatible
with MS-DOS computer

Others:

- HP Deskjet Color
- CBM292/293
- MR400
- EPSON STYLUS PHOTO
- EPSON STYLUS C86
- EPSON STYLUS C65

PCL Level 3

CBM's line thermal printer (Screen hard copying is not possible.)

Sato's barcode printer "MR400 series" (It is not possible to print a screen hard copy, data sheet or sampling data.)

EPSON color ink jet printer STYLUS PHOTO/C86/C65
(For printer models, refer to the separate V-SFT Additional Specifications.)

Connection with Printer through Serial Interface

- To connect a printer through serial interface, connect the cable to a modular jack (MJ1/MJ2).
- Refer to the specification sheet of the printer to be used for the connecting cable for serial interface.
For information on MJ1/MJ2 signals, refer to page 2-13.
- When two printers are connected through parallel interface and serial interface, the one connected to MJ1/MJ2 (refer to page 2-13 for the setting) takes precedence.
- Printer models and available print functions are the same as those for parallel interface.

MEMO

Please use this page freely.

3 Installation

1. Mounting Procedure
2. Power Supply Cable Connection

1. Mounting Procedure

Mounting Procedure

- Cut out the mounting panel (max. thick: 5 mm) to match the dimensions shown below.

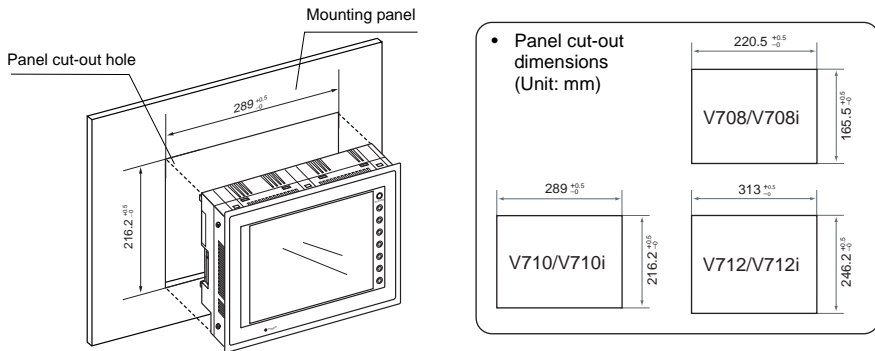

- Insert four fixtures attached to the V7 series into the mounting holes, and tighten them with the locking screws.

<Tightening torque>

V708/V708i/V710/V710i	: 0.3 to 0.5 N•m
V712/V712i	: 0.5 to 0.7 N•m

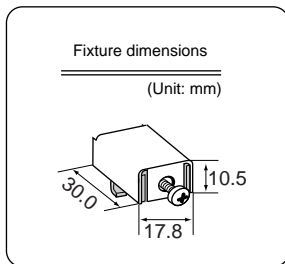

* When the V7 unit is attached to the mounting panel, the fixtures and frame grounds (FG) are connected. To prevent static electricity, be sure to connect the mounting panel to the frame ground.

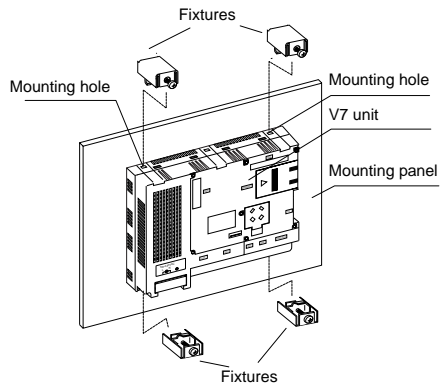

- Mount the gasket so that it will be sandwiched securely between the unit and the mounting panel.

Mounting Angle

Install the unit within the angle of 15° to 135° as shown on the right.

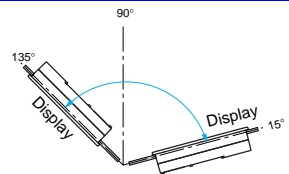

2. Power Supply Cable Connection



DANGER

Electric shock hazard
Shut the power off before connecting the power supply cable.

Power Supply Cable Connection

- Connect the power supply cable to the terminal on the backside of the unit.
 - V708/V708i
 - V710/V710i/V712/V712i

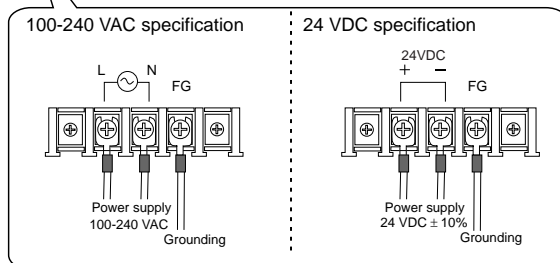
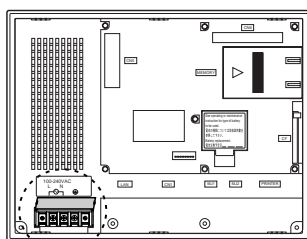
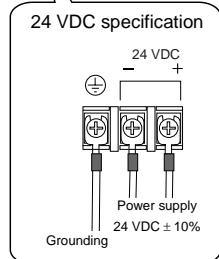
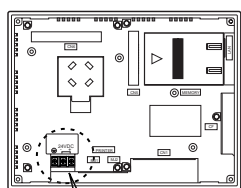

- When connecting the power supply cable, tighten the terminal screws to the following torque.

Model	Terminal Screw		
	Screw Size	Tightening Torque	Crimp-style Terminal (Unit: mm)
V708/V708i	M3.5	0.5 N•m	7.1 MAX 7.1 MAX
V710/V710i/V712/V712i	M4	0.5 N•m	7.9 MAX 7.0 MAX

- The power source must be within the allowable voltage fluctuation.
- Use a power source with low noise between the cables or between the ground and the cable.
- Use as thick a power supply cable as possible to minimize drop in voltage.
- Keep cables of 100 VAC and 24 VDC sufficiently away from high-voltage, large-current carrying cables.

- Be sure to attach the terminal cover to the terminal block.
 - For V708/V708i:
Attach the terminal cover (supplied) to the terminal block.
 - For V710/V710i/V712/V712i:
When closing the terminal cover, hold one end of the cover as shown below.

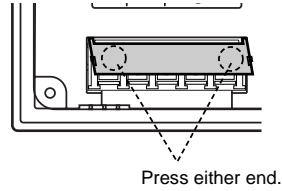
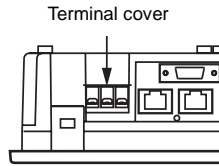

Notes on Usage of 100-240 VAC Specifications

- Generally, an isolating transformer improves noise resistance. However, if the display unit is far away from the secondary port of the transformer and noise gets mixed in, an isolating transformer becomes unnecessary.
- If any power voltage fluctuation caused by noise is expected, it is recommended that a voltage stabilizer (effective in noise resistance) be used.

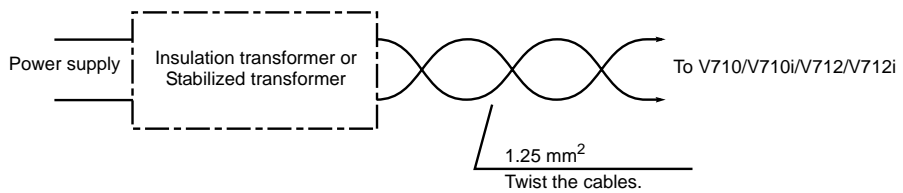

Grounding



CAUTION

Be sure to establish a ground of MONITOUCH.
(The level of grounding resistance should be less than 100Ω.)

- An independent earth pole must be used for MONITOUCH.
- Use a cable which has a nominal cross section of more than 2 mm² for grounding.
- Set the grounding point near the MONITOUCH to shorten the distance of grounding cables.
 - * When the V7 unit is attached to the mounting panel, the fixtures and frame grounds (FG) are connected. To detach the FG terminal from the ground, attach the insulating sheet to the fixtures and the mounting panel for insulation.

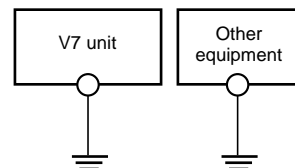

MEMO

Please use this page freely.

4 Instructions

1. Coin-type Lithium Battery
2. DIP Switch Setting
3. Function Switches

1. Coin-type Lithium Battery

CAUTION

The MONITOUCH is delivered without inserting the battery connector in the battery holder on the back of the unit.
 Be sure to set the battery when using the calendar function or SRAM.
 Without battery, the contents in the SRAM or calendar will not be retained.

Battery Mounting Procedure

DANGER

Electric shock hazard
 Steps 2 to 5 must be performed when the power to the V7 unit is turned off.

1. Turn the unit off.
2. Slide the battery holder cover in the direction of the arrow as shown in the left illustration below to open it.

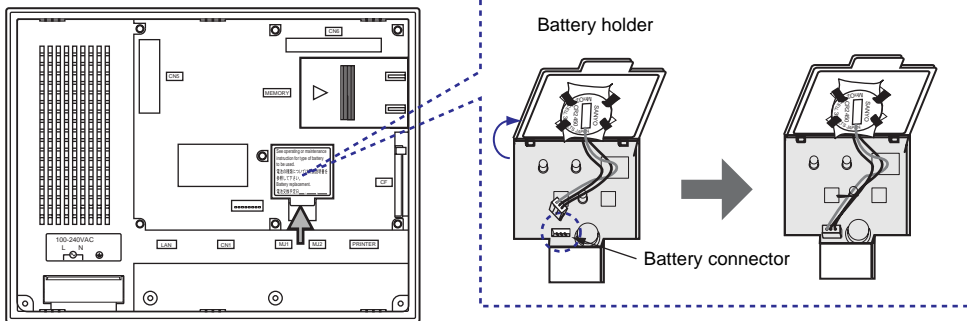

3. Check that the battery is securely attached to the backside of the cover, and connect the battery connector.
4. Close the battery holder cover.
5. Enter a date five years from now for "Battery replacement" on the sticker on the battery holder.

* The battery status is output to the internal memory \$s167 of the V7 series.
 If the battery voltage drops before five years has elapsed, replace the battery immediately.

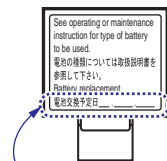

Enter a date five years from now

	MSB	15	14	13	12	11	10	09	08	07	06	05	04	03	02	01	00	LSB
\$s167		0	0	0	0	0	0	0	0	0	0			0				

Memory cassette information reserved (Setting: 0)

- 0: Battery OK
- 1: Battery voltage drop
- 2: No battery

- 0: No memory cassette mounted
- 1: FROM 2 Mbyte (V6)
- 2: FROM 4 Mbyte (V6)
- 3: SRAM 512 byte (V7/V6)
- 4: FROM 8 Mbyte (V7)

Memory cassette information reserved (Setting: 0)

6. Turn on the power to the V7 unit and check that the battery is correctly mounted on the Main Menu screen.

When the battery is not connected, the [SRAM/Clock] switch blinks and the message "Battery not set" is displayed at the bottom left corner. When the battery is correctly connected, the [SRAM/Clock] switch goes out and the message is cleared.

When the battery voltage has dropped, the message "Brownout Battery" is displayed.

Main Menu screen

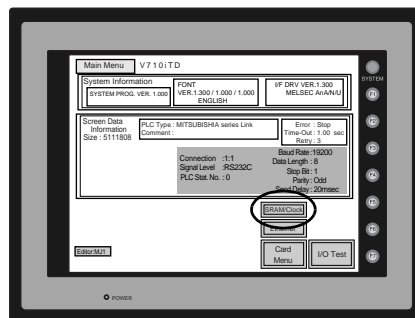

Battery Replacement

Safety Instructions on Handling the Battery

Lithium batteries contain combustible material such as lithium or organic solvent. Mishandling may cause heat, explosion or ignition resulting in fire or injury. To prevent accidents, pay attention to the following cautions when handling the lithium battery.

CAUTION

- Be sure to discharge static electricity from your body before battery replacement.
- Use the battery "V7-BT" (replacement battery for the V7 series) for replacement.
- Rough handling of the battery may cause a fire or chemical burn hazard.
- Do not disassemble, incinerate or heat the battery.
- Observe the local and governmental regulations when disposing of waste batteries.
- Keep batteries out of reach of children (If swallowed, immediately consult a doctor.)
- Never re-charge the battery.
- When the battery leaks or smells, the leaking battery electrolyte may catch a fire. Keep from heat or flame.

Battery Replacement Procedure

Replacement batteries are available from Hakko Electronics.

Name	Type	Contents
Replacement battery for the V7 series	V7-BT	<ul style="list-style-type: none"> Coin-type lithium primary cell 1 pce Cautions sticker 1 pce

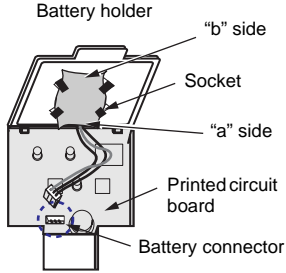
- Replace the battery "V7-BT" within three minutes after the unit is turned off.
If it is not possible to replace within three minutes, use the V-SFT editor (cable: V6-CP) or a CF card and make a backup copy of data in the SRAM.
 - When using the V-SFT editor:
 - Start the V-SFT editor.
 - Click the [Transfer] icon. The [Transfer] dialog is displayed.
 - Select [Display] for [Transfer Device] and [SRAM Data] for [Transfer Data].
To save a backup copy from the V-SFT editor on the server via Ethernet, check Transfer through Ethernet/IP Address of the V7 Equipped with SRAM]. Keep Use Simulator] and Read Comments in Data Transfer] unchecked.
 - Click the [PC <-] under [Transfer Mode].
 - Save the read data in the "*.RAM" file.
 - When using a CF card:
For the backup procedure with a CF card, refer to "Chapter 6 MONITOUCH Operations".
- Turn the unit off, and open the battery holder. A battery is set at the socket.
- Unplug the battery connector, and remove the battery from the socket. Take out the battery while pressing the center of the battery holder cover as shown in the figure.
 
- Set a new battery. Fit the battery into the socket in such a manner that the red cable side of the battery faces the board and the cable branches from the bottom. Insert the battery in the "b" side first, and push it down to "b" while inserted in the "a" side.
 
- Plug in the battery connector and close the battery holder cover.
- Remove the existing caution sticker. Enter a date five years from now for "Battery replacement" on the new caution sticker, and attach it to the backside of the unit.
- When the backup copy of the SRAM data has been saved in step 1, turn on the unit and load the data to the unit.

2. DIP Switch Setting

DIP Switch (DIPSW) Setting

Set the terminating resistance for RS-422/485 connection with the DIP switch.

When setting the DIP switch, turn the power off.

- For V708/V708i:

- For V710/V710i/V712/V712i:

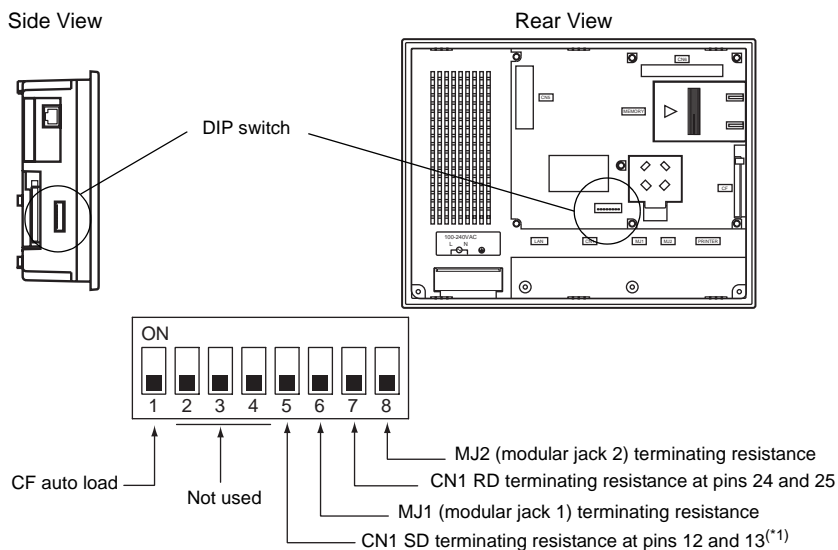

*1 V708iSD: Available with hardware ver. "a" and later
 V708CD/V708SD/V710/V712: Available with hardware ver. "b" and later

DIPSW1 (CF Auto Load)

Set DIPSW1 ON when a screen data file saved on a CF card can be auto-loaded.

Procedure

1. Transfer screen data from the computer to a CF card. (Refer to the Reference Manual for more information.)
2. Set DIPSW1 in the ON position, and insert the CF card that contains the screen data file.
3. Turn the unit on. The screen data is automatically loaded into the FLASH memory of the unit.

DIPSW2,3,4 (Not Used)

Keep OFF.

DIPSW5, 6, 7, 8 (Terminating Resistance Setting)

- When connecting the PLC at CN1 via RS-422/485 interface (2-wire connection), set DIPSW7 to the ON position.
- When connecting the PLC at CN1 via RS-422/485 interface (4-wire connection), set DIPSW5 *1 or 7 to the ON position.
- For the following connections at modular jack 1 (2), set DIPSW 6 (DIPSW8) to the ON position.
 - Master station for multi-link 2 connection
 - Temperature controller network/PLC2Way connection via RS-485
 - Card Recorder: Connection with the CREC (optional)
 - Serial extension I/O: Connection with the V-I/O (optional)
 - Connection to the V7 series at the termination of V-link connection via RS-485

3. Function Switches

Types

- There are eight function switches provided.
[SYSTEM], [F1], [F2], [F3], [F4], [F5], [F6], [F7]

[SYSTEM] Switch

The [SYSTEM] switch works in “alternate” operations. When this switch is pressed once, the switch menu is displayed at the side of the function switches [F1] to [F5], and each function switch corresponds to the menu item displayed in the switch menu. When the [SYSTEM] switch is pressed again, the switch menu disappears, and the function switches [F1] to [F7] work as defined by the user. (page 4-6)

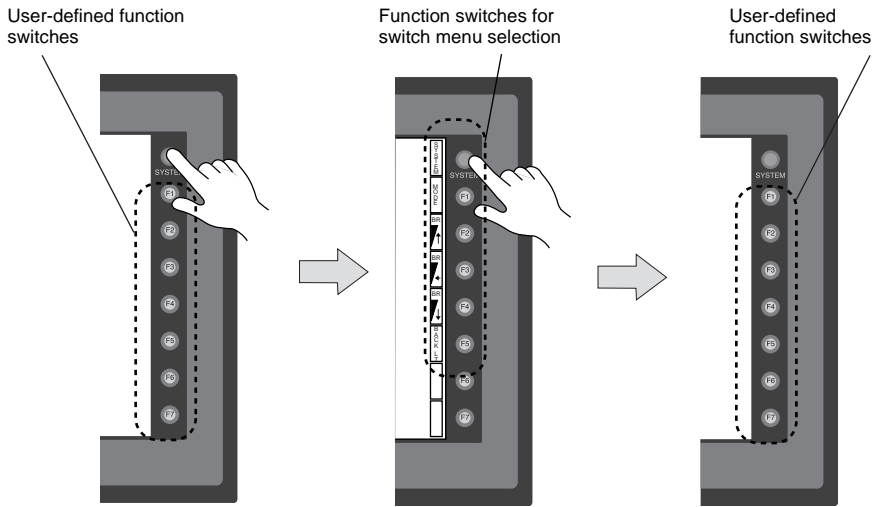

For V710T, V710iT, V710S, V710iS, V710iS, V712S and V712T

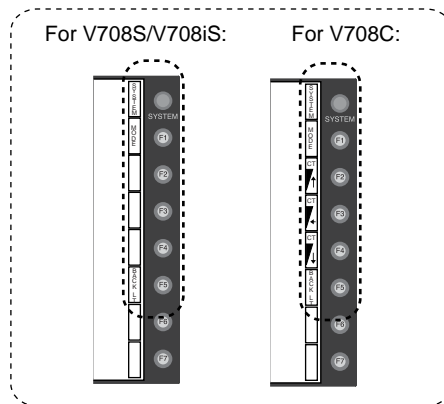

User-defined Function Switches [F1] to [F7]

- When the V7 series is in the STOP mode, the function switches do not work.
- When the V7 series is in the RUN mode and the switch menu by the [SYSTEM] switch is not displayed, the function switches can be defined by the user.
- User-defined function switches should be set in the following dialogs of the V-SFT editor.
 - Settings for each screen
[Edit] → [Local Function Switch Setting] → [Function Switch Setting] dialog
 - Setting for all screens
[System Setting] → [Function Switch Setting] → [Function Switch Setting] dialog

[F1] to [F5] Switch Functions with Switch Menu

Functions		Contents				
F1	Mode	Selects the operation mode between STOP ↔ RUN.				
F2 F3 F4	Contrast Brightness	Item	Contrast Adjustment		Brightness Adjustment	
			Adjust the contrast. Holding down the switch for one second or more changes the contrast rapidly.		Adjusts the screen brightness in three levels.	
		Applicable Models	V708C, V710C		V710T, V710iT, V710S, V710iS, V712S, V712T	
		Adjustment	F2 F3 F4 ←—————→ Dark Medium Pale		F2	F3 ^{*1}
		1 Bright	2 Medium	3 Dark		
F5	Backlight	Turn the backlight on and off. Backlight control should be set on the V-SFT editor. ([System Setting] → [Unit Setting] → [Unit Setting] dialog, [Backlight] tab window)				
		Always ON	Auto 1/Auto 2/Auto 3		Manual/Manual 2	
		Ignored	<ul style="list-style-type: none"> • The [F5] switch turns the backlight off. • This is valid when the backlight control bit (bit 11) in the read area "n + 1" in the system memory is reset (OFF: 0). 		<ul style="list-style-type: none"> • Manual The [F5] switch turns the backlight off. To turn it on, press somewhere on the screen or a function switch. • Manual 2 The [F5] switch turns the backlight on and off. • [Backlight Power ON Time Control] that determines the backlight status at power-up becomes valid. When the power is turned on: ON → Backlight ON OFF → Backlight OFF 	

*1 When a medium or dark brightness is set, the backlight service life may become shorter.

5 Connections

1. 1 : 1 Connection
2. 1 : n Connection (Multi-drop)
3. n : 1 Connection (Multi-link 2)
4. n : 1 Connection (Multi-link)
5. Universal Serial Communications
6. V-Link
7. PLC2Way
8. Temperature Control Network
9. Ethernet
10. Other Networks

1. 1 : 1 Connection

- One set of the V7 series is connected to one PLC (1 : 1 connection).

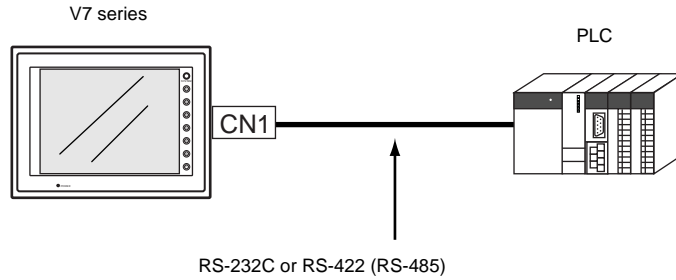

- The host link unit of the PLC or the CPU port is used and the V7 series (master station) establishes communications according to the protocol of the PLC. Consequently, it is not necessary to have the dedicated communication program on the PLC (slave station). The V7 series reads the PLC memory for screen display. It is also possible to write switch data or numerical data entered through the keypad directly to the PLC memory.

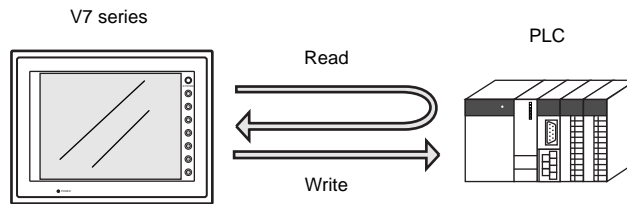

- For more information on wiring and communication settings, refer to the PLC Connection Manual.

2. 1 : n Connection (Multi-drop)

One V7 series is connected to multiple PLCs. (Maximum connectable PLCs: 31)

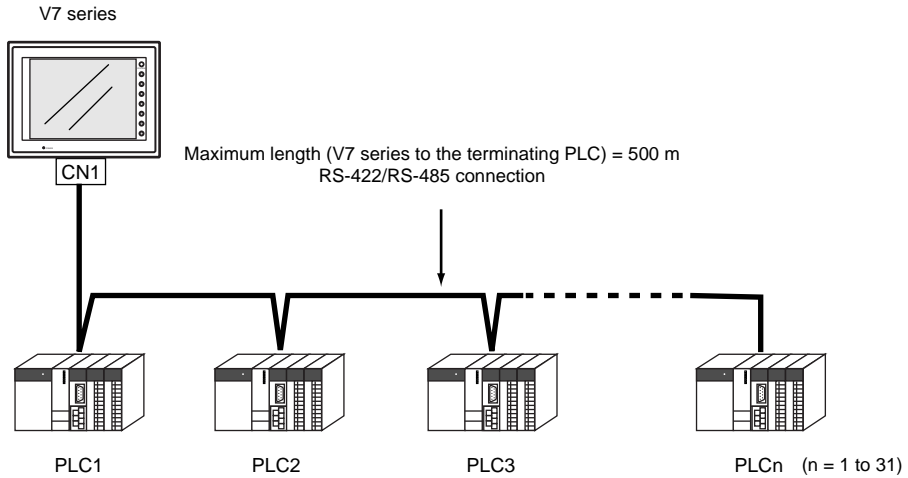

- For more information on wiring and communication settings, refer to the PLC Connection Manual.

3. n : 1 Connection (Multi-link 2)

- One PLC is connected to a maximum of four V7 series.
- An original network is created where the V7 series (Local Port 1) that is directly connected to the PLC is the master station, and other three V7 series are slave stations. Only the master station makes communications directly with the PLC, and the slave stations make communications with the PLC via the master station.

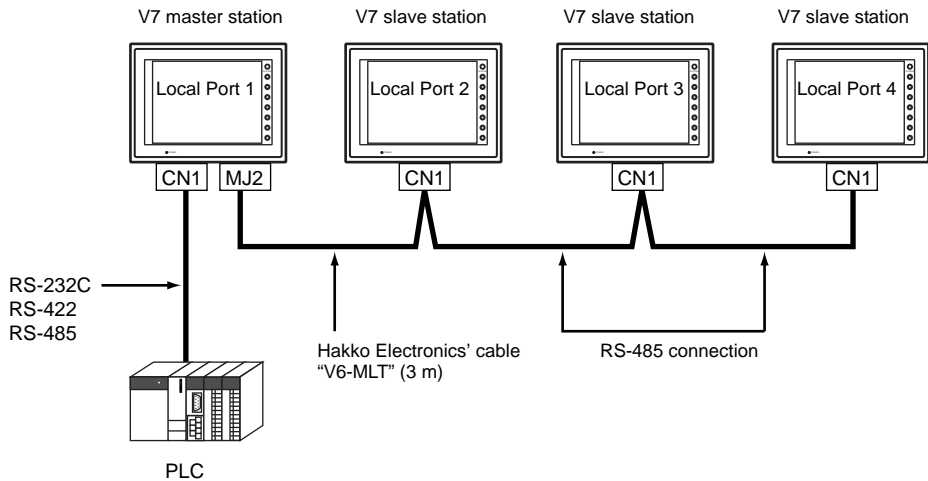

- Communications between the V7 master station and the PLC depend on the communication speed set on the PLC. The maximum available speed for the V7 series is 115 kbps, which is higher than the one available with multi-link connection described in “4. n : 1 Connection (Multi-link).”
- This multi-link connection is available with almost all the PLC models that support 1 : 1 connection (refer to the Appendix).
(The connection between the master station and the PLC is the same as the one for 1 : 1 connection.)
- Use the RS-485 2-wire connection between stations of the V7 series. Please use HAKKO Electronics' multi-link 2 master cable (V6-MLT) for connection between the master station (Local Port 1) and the slave station (Local Port 2).
- When the communication interface unit (example: OPCN-1, CC-LINK, Ethernet, etc.) is used, “multi-link 2” cannot be used.
- The V7 and V6 series can be used together. The V6 series can be the master station. (However, when V606/V606i is the master station, the slave station must be V606/V606i. Also, depending on the hardware version of the V6 series, multi-link 2 connection may not be supported. Refer to the V6 Hardware Specifications.)
- For more information on wiring and communication settings, refer to the PLC Connection Manual.

4. n : 1 Connection (Multi-link)

- One PLC is connected to multiple V7 series. (Maximum connectable units: 31)

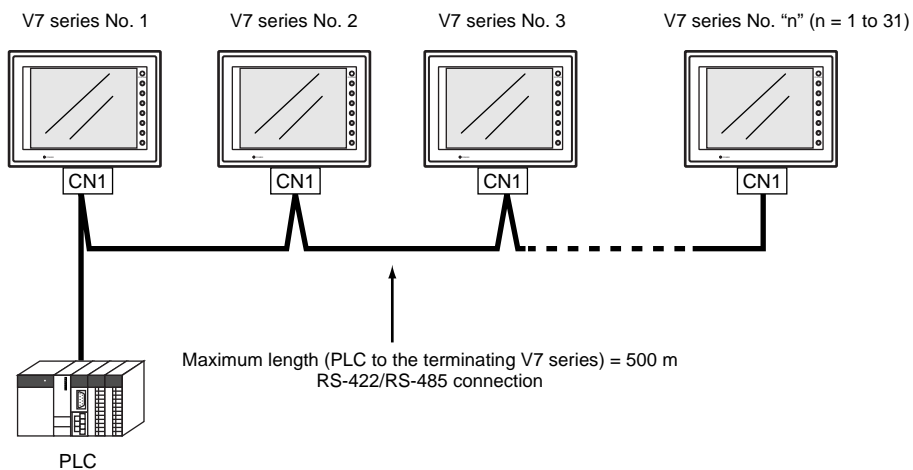

- The PLC must be of the type of signal level RS-422/RS485 with port numbers. RS-422 connection between the V7 series ↔ PLC must be in 2-wire connection.
- The V7 and V6 series can be used together.
- For more information on wiring and communication settings, refer to the PLC Connection Manual.

5. Universal Serial Communications

- A general purpose computer or an ASCII unit of the PLC (master station) controls the V7 series (slave station) using dedicated commands.

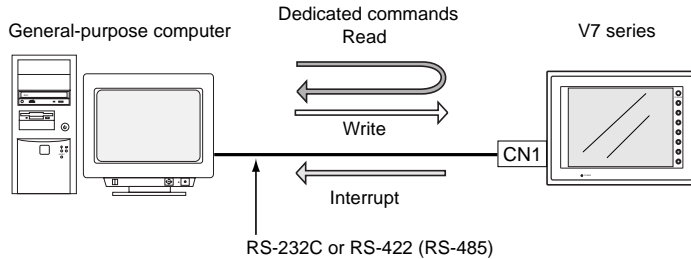

- The V7 series internal user memory addresses (\$u) must be used for memory allocation for switch, lamp or data display parts.
When the master station specifies a screen number, data is written to the internal memory address (\$u) allocated for the screen. If the screen is switched internally, the new screen number is read and is written to the internal memory address (\$u) allocated for the screen.
- For 1 : 1 connection, the V7 series can send an interrupt to the master station through switch activation, write command from the keypad, and screen change.
- Use CN1 of the V7 series for connection with a general-purpose computer. Either signal level RS-232C or RS-422 (RS-485) can be selected.
- In addition to 1 : 1 connection, 1 : n connection is available between the general-purpose computer and the V7 series via RS-422.
(A maximum of 32 V7 series can be connected.)
For 1 : n connection, interrupts cannot be used.

General-purpose computer

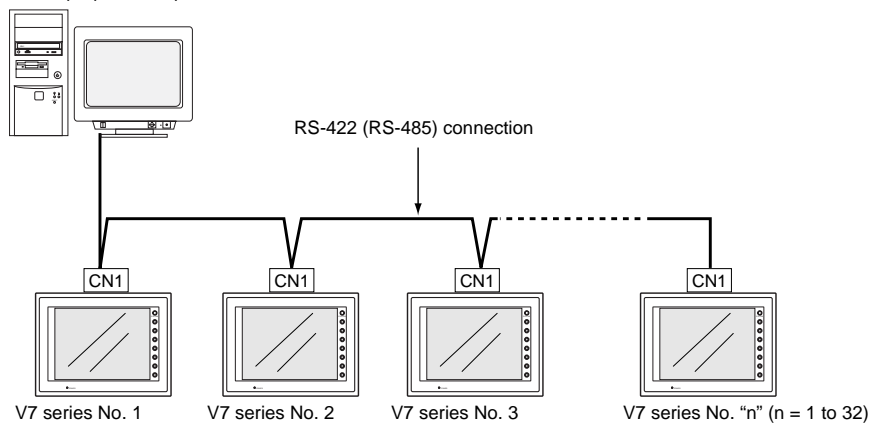

- For more information, refer to the PLC Connection Manual.

6. V-Link

- “V-Link” is the network where the computer reads from and writes to the internal memory of the V7 series, memory card, PLC memory or temperature control/PLC2 memory using a dedicated protocol.

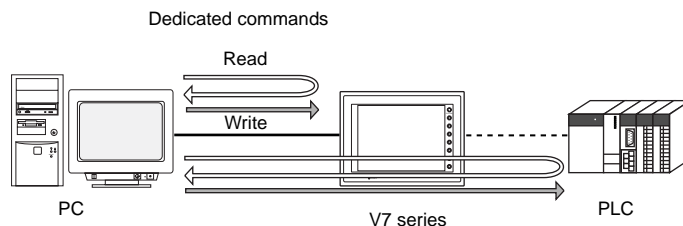

- Use the MJ port of the V7 series for connection with a general-purpose computer. For connection to the PLC using a temperature controller or the PLC2Way function, use the other MJ port and use CN1 for communications with the PLC. Data of the PLC or temperature controller can be collected through communications with the V7 series. Data collection is available even between the products of different manufacturers.
- Either signal level RS-232C or RS-485 can be selected. With RS-232C, one V7 series can be connected; with RS-485, a maximum of 31 V7 series can be connected.

<RS-485 connection>

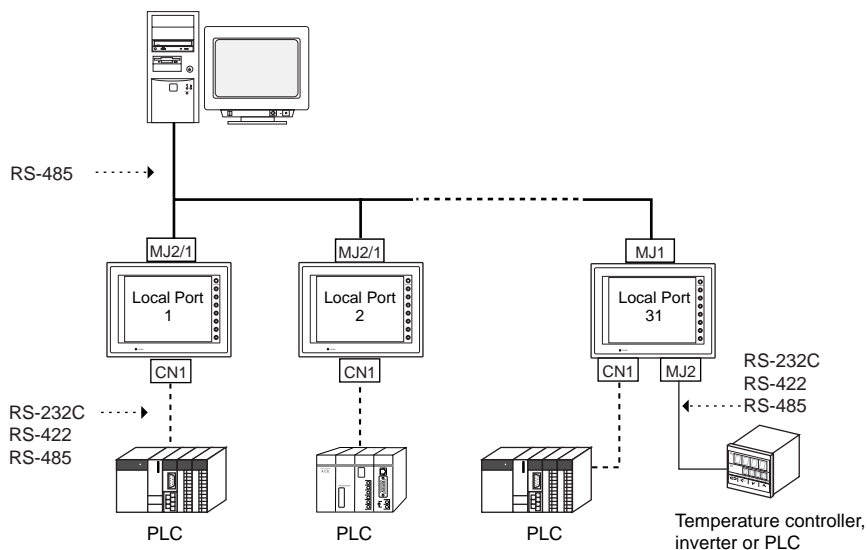

- For more information, refer to the PLC Connection Manual.

7. PLC2Way

- The “PLC2Way” function is an original network function where one V7 series can be connected to two PLCs. Even if the manufacturers of these PLCs are not the same, they can be connected to one V7 series.

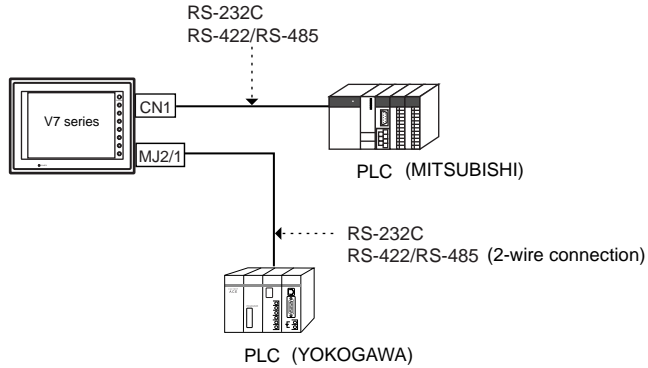

- Connect one PLC to the CN1 connector, and the second PLC to the MJ port.
- With the PLC2Way function, it is possible to communicate with PLCs without special program in the same way as 1 : 1 connection.
Two PLCs that are connected to the V7 series are controlled at the same time, and memory read/write operations are available with these two PLCs.
- Connection at the MJ port can be performed via RS-232C or RS-485 (2-wire).
With RS-232C, one PLC can be connected; with RS-485, a maximum of 31 PLCs can be connected.

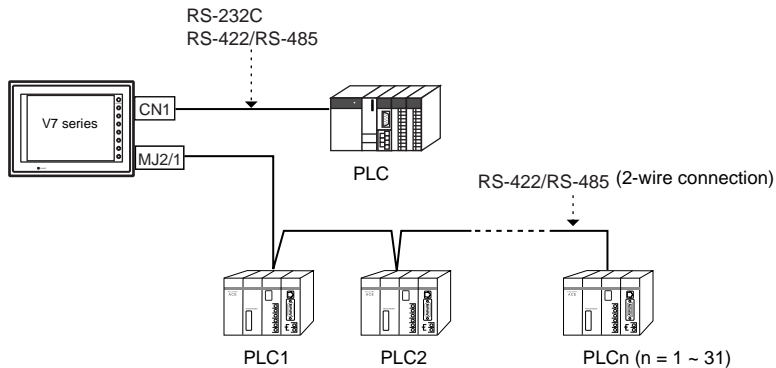

- Constant reading/sampling of PLC data connected to the MJ port
When read/write memory addresses are preset on the temperature control network/PLC2Way table, background data reading is performed at regular intervals. It is also possible to save the read data in the V7 internal buffer, SRAM or CF card.
- Data transfer between PLCs
The PLC memory data can be transferred to another PLC in blocks using a macro command.
- For more information, refer to the PLC Connection Manual.

8. Temperature Control Network

- Using the temperature control network, the V7 series can be connected to the temperature controller or inverter.
With RS-232C, one PLC can be connected; with RS-485, a maximum of 31 temperature controllers can be connected.

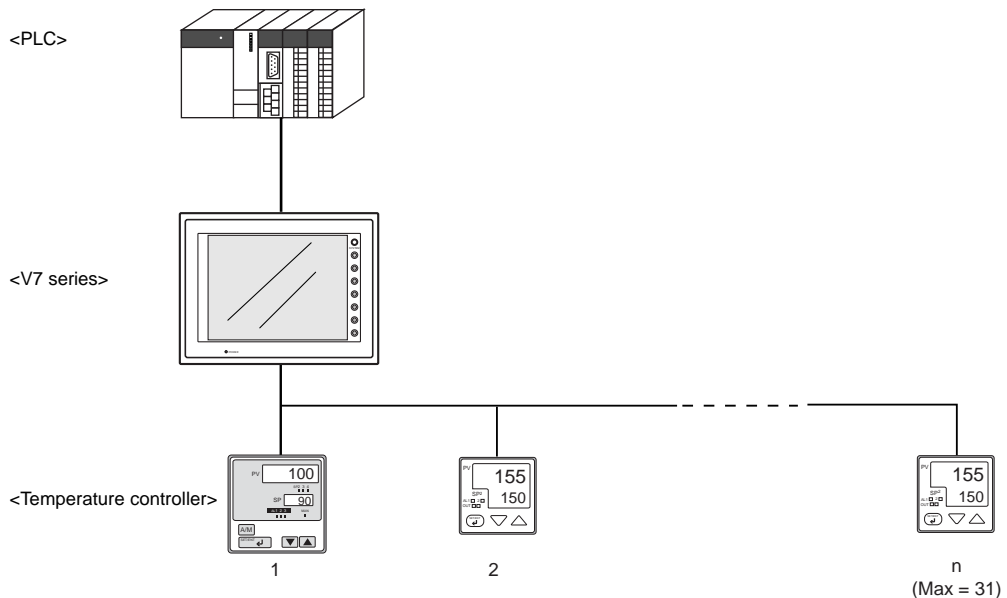

- Data of temperature controllers connected to the V7 series can be set or monitored.
- Periodical reading/sampling of temperature controller data
When read/write memory addresses are preset on the temperature control network/PLC2Way table, background data reading is performed at regular intervals. It is also possible to save the read data in the V7 internal buffer, SRAM or CF card.
- Data transfer
It is also possible to transfer data in the PLC memory, V7 internal memory or a memory card to the temperature controller at one time using a macro command. Conversely, data in the temperature controller can be transferred to the PLC memory, V7 internal memory or a memory card at one time.
- For more information, see the Temperature Control Network Manual.

9. Ethernet

- Transferring data in memory

Data in memory can be transferred to the V7 series on the Ethernet or to the PLCs linked to the V7 series as a host by using macro commands (EREAD/EWRITE).

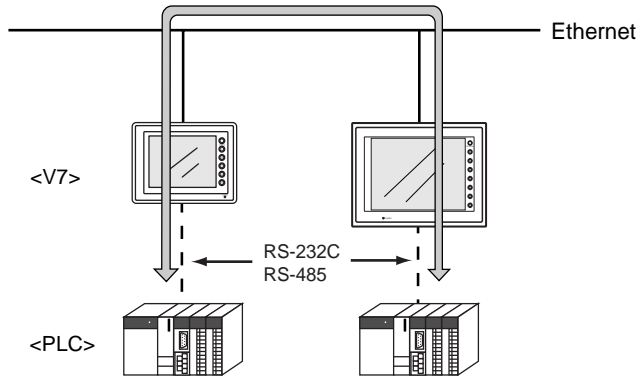

- Communications between the server and the V7 series

- "HKEtn10.dll" (for UDP/IP protocol) is provided so that the user can create an original application by using Visual C++ or Visual Basic, etc. to allow the server to access the memory device, such as V7 internal memory, memory card or the PLC memory linked with the V7 series as a host..... (a)
- The macro command (SEND) enables the V7 series to access the server..... (b)

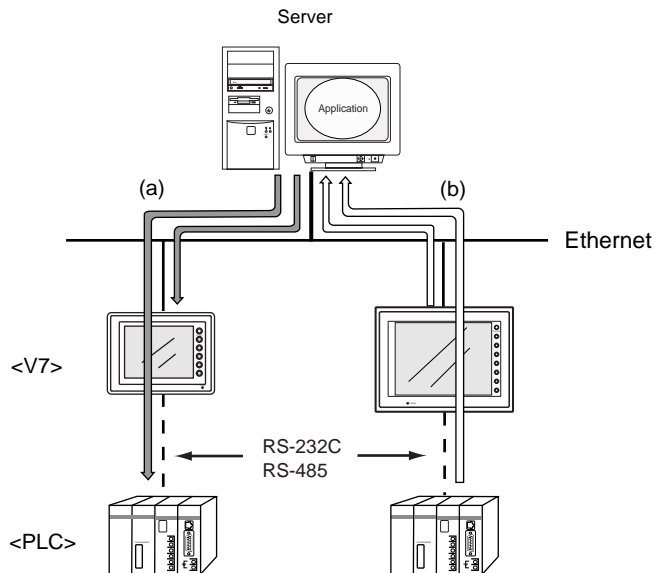

- Screen data can be transferred from the V-SFT editor on the server to the V7 series.

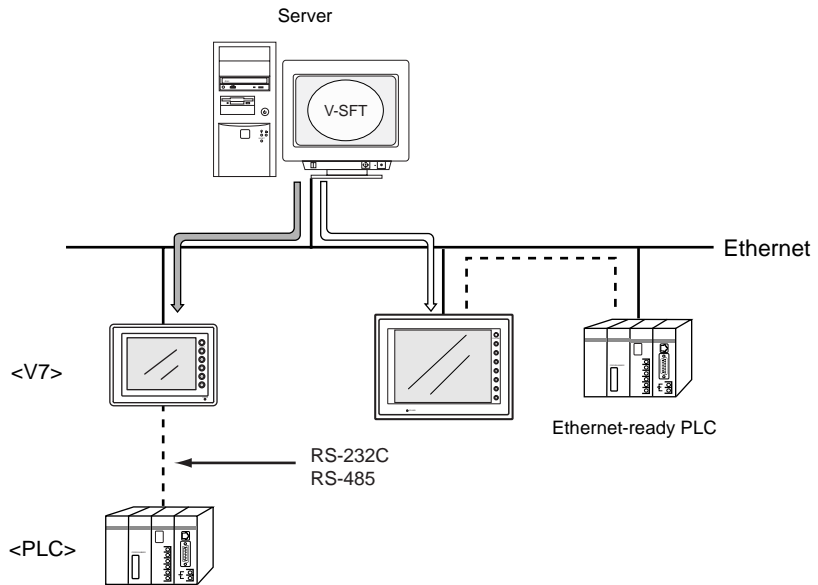

- Communications between the Ethernet-ready PLC and the V7 series
 - The V7 series can communicate with the PLC on the Ethernet.

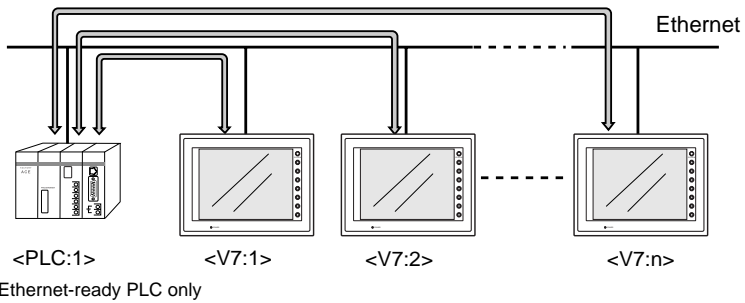

- The V7 series can communicate with multiple PLCs on the Ethernet.

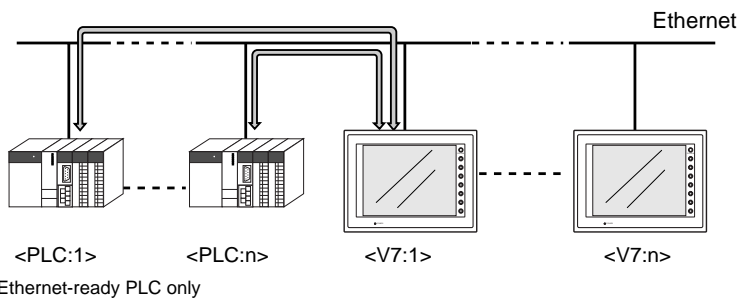

- For more information, refer to the PLC Connection Manual.

10. Other Networks

FL-net (OPCN-2)

- FL-net (OPCN-2) is standard specifications of the controller-level FA network that the Manufacturing Science and Technology Center has developed, which enables a communication network between multi-vendor programmable controllers, NCs and robot controllers. It is possible to connect FA controllers and computers, such as programmable controllers (PLCs) or NC controllers (CNCs), of different manufacturers as shown below for control and monitoring.

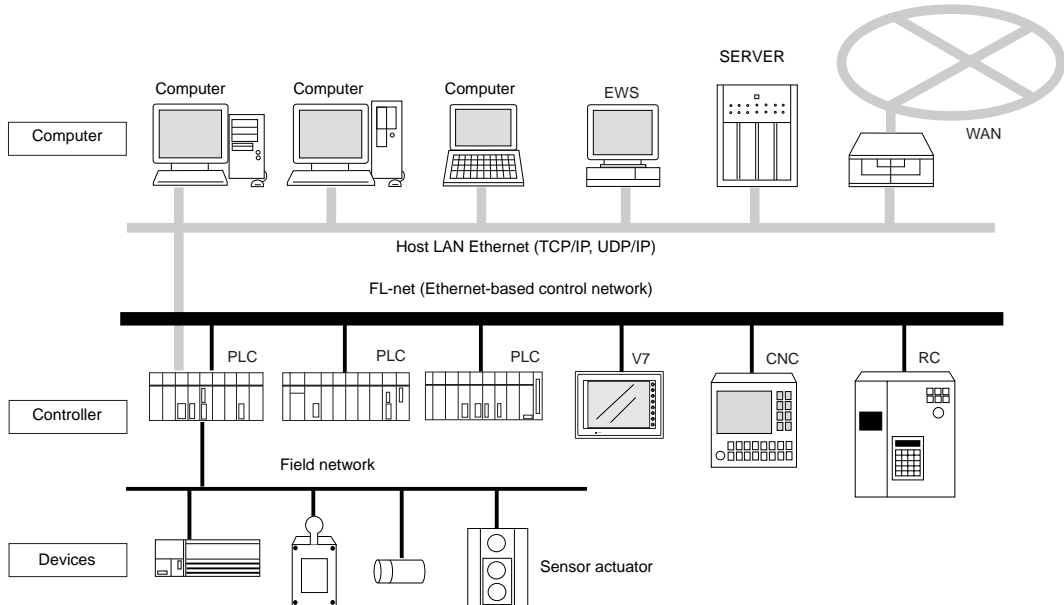

- To use FL-net (OPCN-2) communications on the V7 series, the communication interface unit “CU-03-2” must be mounted. When the V7 series is equipped with the communication interface unit CU-03-2, it becomes an FL-net (OPCN-2)-ready device.
- When CU-03-2 is mounted for FL-net (OPCN-2) communications on V7i, the 10BASE-T connector (LAN) provided on the unit cannot be used. Consequently, it is not possible to use FL-net (OPCN-2) communications and Ethernet communications at the same time.
- When transferring screen data, use the 10BASE-T connector on the communication interface unit CU-03-2.
Be sure to set the IP address, etc. on the Main Menu and Ethernet screens.
For the setting procedure, refer to “Chapter 6 MONITOUCH Operations.”

MELSECNET/10

- MELSECNET/10 is the network system that is developed by MITSUBISHI Electric Corporation. When the V7 series is equipped with the communication interface unit CU-05 is mounted, it can work as a NET/10 station (a sub-control station).

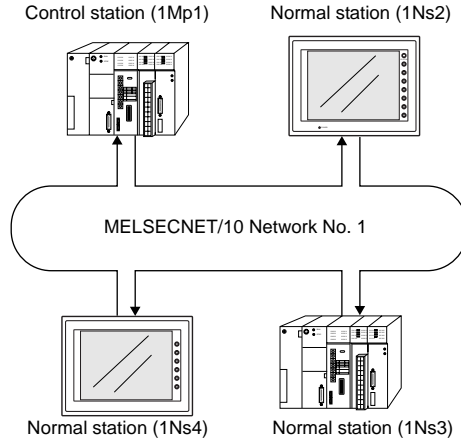

- For communications with the PLC, no program is required in the same way as communications via a link unit.
- The V7 series supports the optical loop system of NET/10. Use fiber-optic cables for connection.

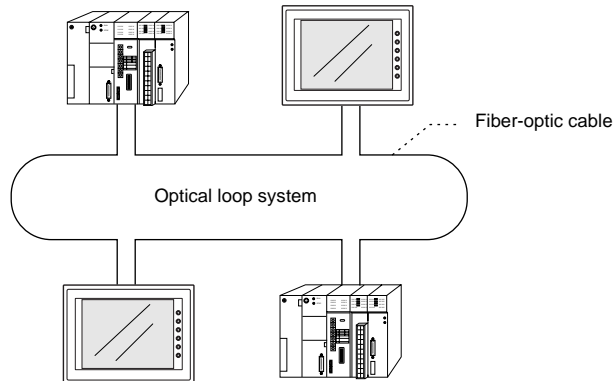

- This network system supports cyclic transmission and enables direct reading from link devices (LB, LW, LX or LY). Also it is possible to directly write data to link devices that are assigned by the control station.

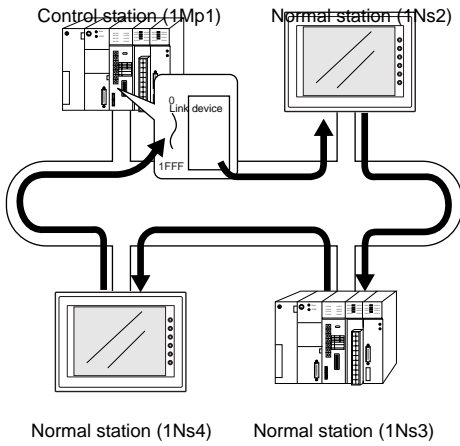

Example: When LW is assigned by the control station as shown below:

0 ~ FF	1Mp1
100 ~ 1FF	1Ns2
200 ~ 2FF	1Ns3
300 ~ 3FF	1Ns4

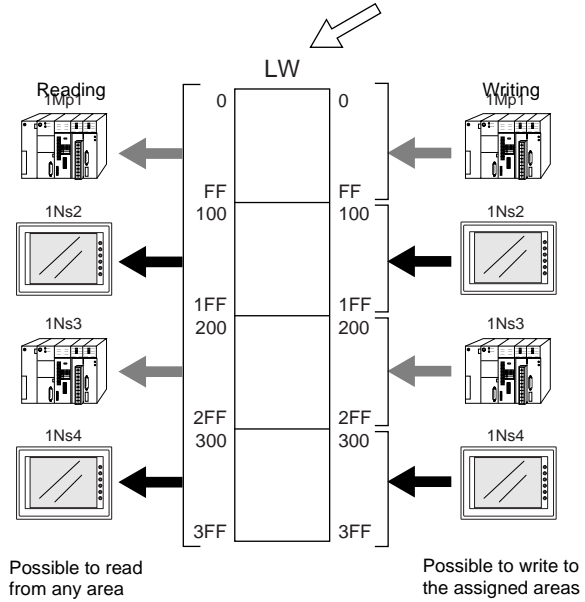

- Transient transmission is also supported. It is possible to access to memory addresses such as D or M that are usable with the ordinary 1 : 1 communications. All the memory areas in the PLCs on NET/10 can be accessed.

Note:
 Transient transmission is slower than cyclic transmission (2- or 3-times longer response time than cyclic transmission). To achieve high-speed communications, use cyclic transmission.

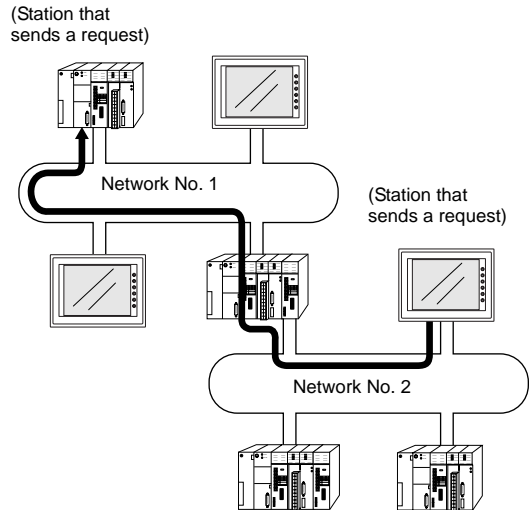

CC-Link

- CC-Link is the network that is developed by MITSUBISHI Electric Corporation. The V7 series works as a local station (intelligent device station).
- To use CC-Link communications on the V7 series, the communication interface unit "CU-02" must be mounted. When the V7 series is equipped with the communication interface unit CU-02, it becomes a CC-Link-ready device.
- For communications with the PLC, no program is required in the same way as communications via a link unit.
- It is possible to perform high-speed communications by connecting multiple remote/local stations to one master station (PLC).
Example: System configuration with two V7 series

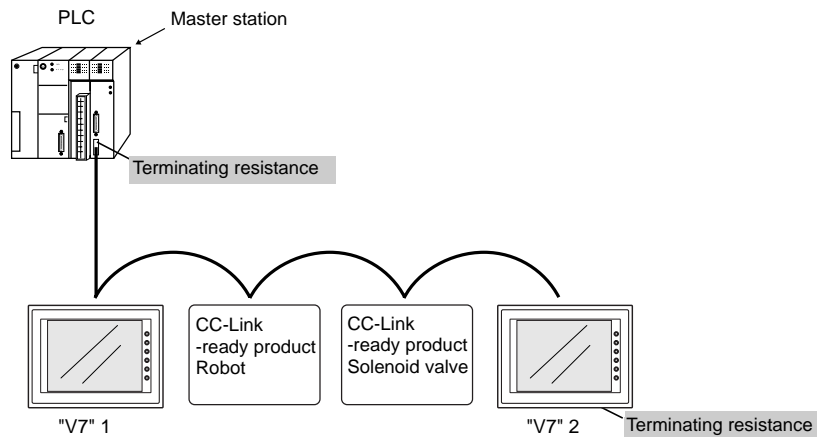

- For more information, refer to the Specifications for Communication Unit "CC-Link."

OPCN-1

- To use OPCN-1 communications on the V7 series, the communication interface unit “CU-00” must be mounted. When the V7 series is equipped with the communication interface unit CU-00, it becomes an OPCN-1-ready device.
- The V7 series that supports OPCN-1 communications is a programmable display that can perform data transfer with the master station (PLC, etc.) in compliance with “JEM-F3008 programmable controller field network standard (level 1)” (normally called “OPCN-1”) that is determined by the Japan Electrical Manufacturers' Association.
- The GET/PUT service is supported, and communications with the PLC can be performed without program in the same way as communications via a link unit.
- The V7 series that supports OPCN-1 communications falls in the TYPE-S51I class.

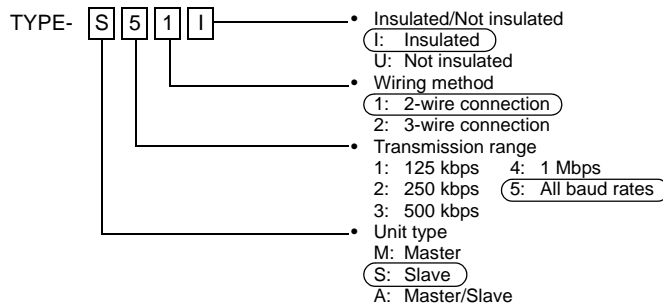

- It is possible to perform high-speed communications by connecting multiple slave stations to one master station (PLC).
Example: System configuration with two MONITOUCH units

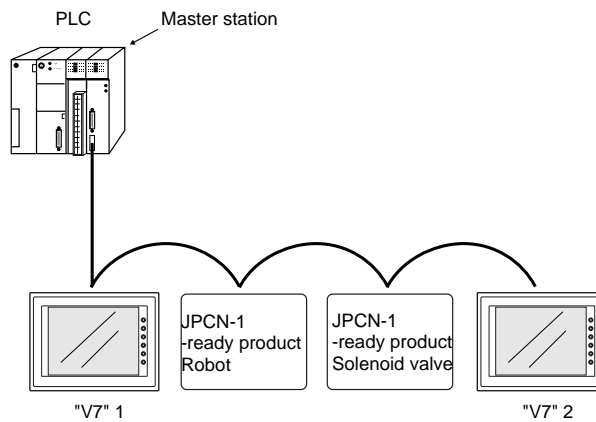

T-LINK

- To use T-LINK communications on the V7 series, the communication interface unit "CU-01" must be mounted. When the V7 series is equipped with the communication interface unit CU-01, it becomes a T-LINK-ready device.
- The V7 series that supports T-LINK communications can perform long-distance high-speed data transmission with the Fuji Electric's PLC MICREX-F series.
- The V7 series updates the display when the read data (V7 series ← PLC) is changed. The V7 series reads data from the PLC memory addresses that are allocated to the items placed on the screen, such as lamp parts or counter parts.
When switch data or counter setting data on the V7 series should be written, the V7 series issues a write command to the PLC and writes the output data to the PLC memory.
These operations are automatically performed on the V7 unit and no special communication program is required on the PLC side.

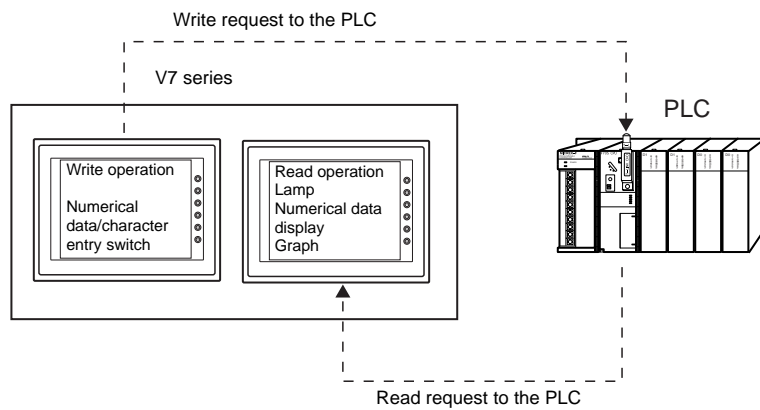

PROFIBUS-DP

- PROFIBUS is an open field bus independent on the bender that is used for various applications in factory automation and process automation. PROFIBUS provides a communication protocol (communication profile) that supports system hierarchy, i.e. DP and FMS.
- When the V7 series is equipped with the communication interface unit CU-04 is mounted, PROFIBUS-DP communications can be performed.

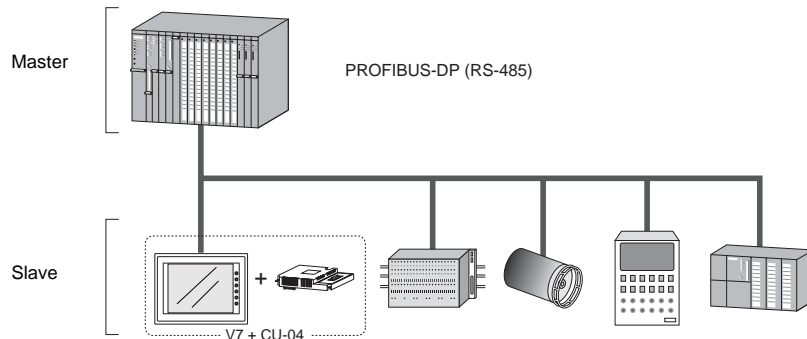

The V7 series can work as a slave station on PROFIBUS-DP.
A maximum of 12 Mbps is available (automatically set to the BUS baud rate).
The signal level is RS-485.

* The V7 series can only communicate with the master PLC.

- PROFIBUS-DP supports I/O communications only. With I/O communication, it is not possible to directly access the device memory (DB or MW) used in the CPU. To enable the V7 series to have direct access to these memory devices, Hakko Electronics' supplies the function (ladder file) for message communications. When this function is loaded in the master CPU, message communications using Hakko Electronics' original protocol are enabled, and the V7 series can have access to any memory address.

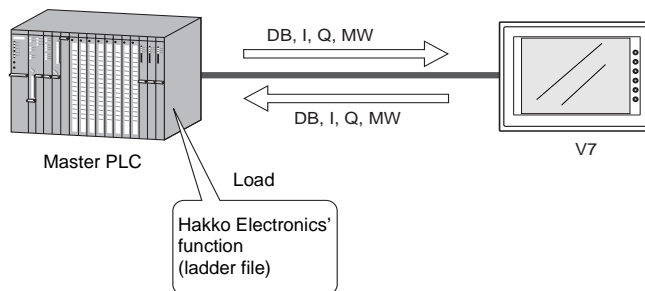

- For the procedure of loading Hakko Electronics' function, refer to the Specifications for Communication Unit "PROFIBUS-DP."

DeviceNet

- DeviceNet is an open field network that aids in interconnecting individual control devices, such as PLCs, computers, sensors, or actuators. For more information on the DeviceNet, refer to the DeviceNet Specification issued by ODVA*.

* Open DeviceNet Vendor Association, Inc.

ODVA, Open DeviceNet Vendor Association, Inc., is an independent organization that controls the DeviceNet specifications. ODVA is formed by vendors with the objective of achieving widespread use of its DeviceNet globally.

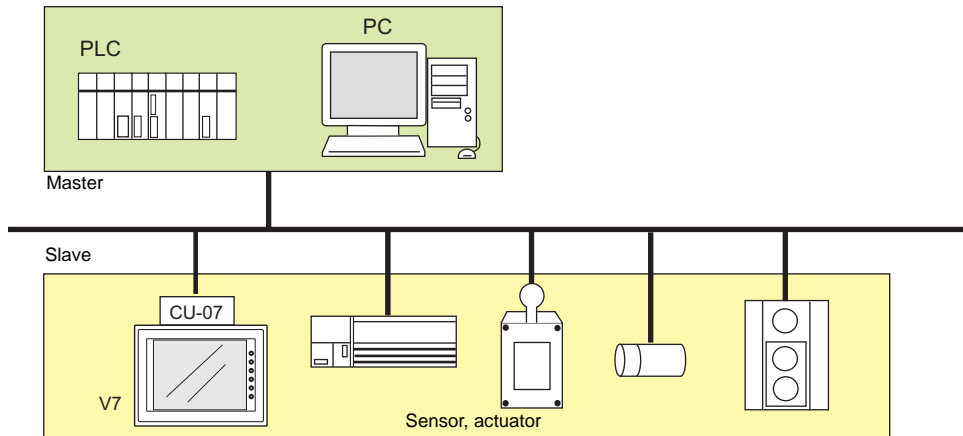

- With a communication interface unit CU-07 installed on the V series, it can communicate with other components as a slave of the DeviceNet.
- The CU-07 supports the I/O message polling function.

6 **MONITOUCH** **Operations**

1. Operational Procedures
2. Main Menu Screen

1. Operational Procedures

MONITOUCH Operation

Follow the procedure below to operate the MONITOUCH.

1. Installation and wiring
For more information, refer to “Chapter 3.”
2. Connection with devices including a PLC and a temperature controller
For instructions and precautions on wiring between the MONITOUCH and other devices, refer to the separate “PLC Connection Manual.”
3. MONITOUCH power-on
 - New MONITOUCH

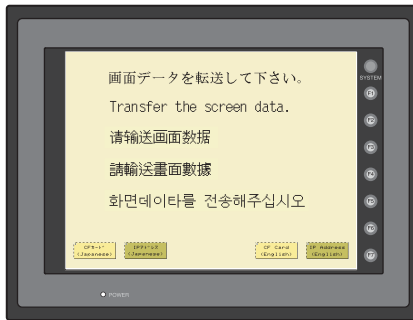

- Other than the above
When the check screen below and then the next user screen are displayed correctly, go to step 5.

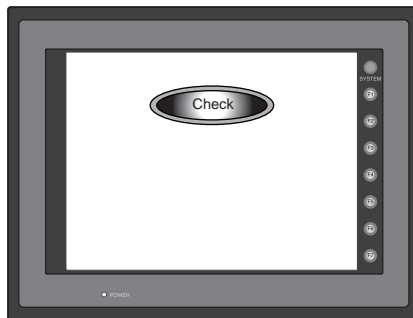

4. Screen data creation and transfer
 - New MONITOUCH
“Initial Screen” (page 6-2)
 - Other than the above
Refer to Chapter 5, “Data Transference” in “Reference Manual (Operation).”
5. Operation start
The MONITOUCH becomes operable with a PLC or a computer connected to it.
 - * If the MONITOUCH does not operate normally and shows an error message, eliminate the cause by referring to “Chapter 7.”

Initial Screen

When the power of MONITOUCH is turned on for the first time, the Main Menu screen shown below on the left is displayed.

Initial screen displayed when power is turned on for the first time

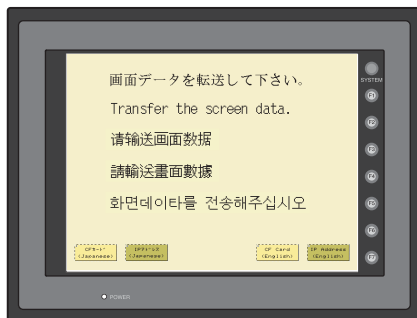

Main Menu screen after transferring screen data

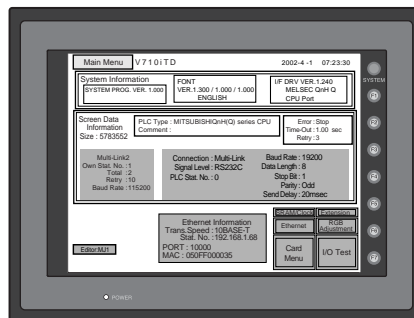

Transferring Screen Data for the First Time

There are four methods for transferring screen data for the first time.

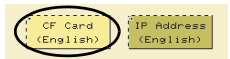
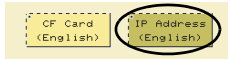
- Transferring screen data via the V6-CP cable
 - Transfer screen data from the computer while the initial screen is displayed.
- Transferring screen data using the CF card or the memory card and the card recorder (CREC)
 - Transfer screen data to a card from the computer.
 - Insert the CF card into the V7 series or connect the card recorder and insert the memory card into the card recorder (CREC).
 - Press the [CF Card (English)] switch. The "Card Menu" screen is displayed.
 
 - Follow the instructions as described in "Card Menu Screen" (page 6-11) and transfer screen data.
- Transferring screen data via Ethernet
 - Press the [IP Address (English)] switch.
 
 - The "Ethernet" screen is displayed. Follow the instructions as described in "Ethernet" (page 6-23) and set the IP address. Press the [Setting Finished] switch. The initial screen is displayed again.
 - Transfer screen data from the computer via Ethernet.
- Auto-uploading screen data from the CF card to the V7 series
 - Transfer screen data from the computer to a CF card.
 - Turn the V7 unit off. Set the DIPSW1 on the unit to the ON position, and insert the CF card.
 - Turn the unit on. The screen data is automatically uploaded from the CF card to the V7 series.

2. Main Menu Screen

- To bring up the Main Menu screen in the RUN mode, press the [SYSTEM] switch and then the [F1] switch while the vertical menu is displayed.

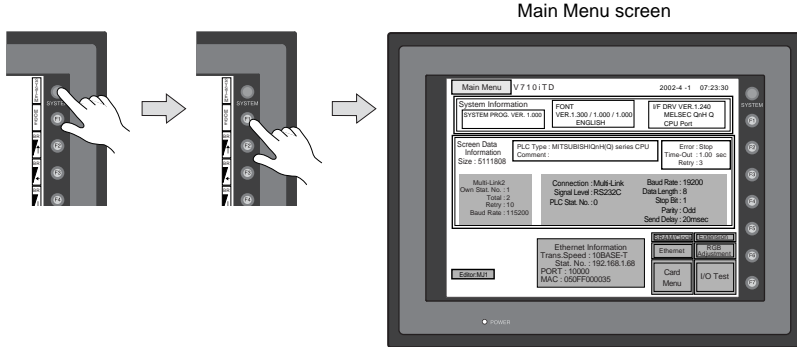

- The Main Menu screen indicates the V7 series model, system information, and screen data information.
- The Main Menu screen is the system menu screen for transferring screen data between a personal computer and the V7 series. When transferring screen data from a personal computer to the V7 series, this Main Menu screen must be displayed. (However, if [Editor Port] is selected for [Modular Jack 1] or on-line editing is used, it is not necessary to bring up this screen.)

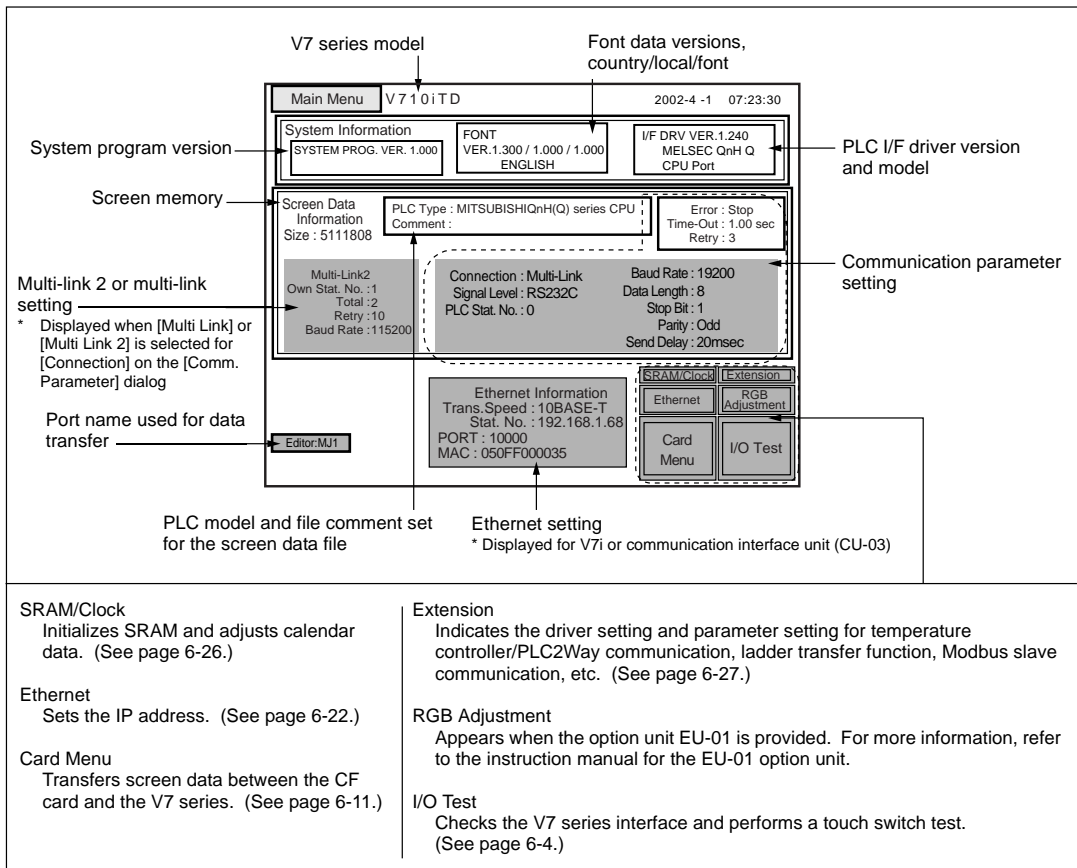

SRAM/Clock
 Initializes SRAM and adjusts calendar data. (See page 6-26.)

Ethernet
 Sets the IP address. (See page 6-22.)

Card Menu
 Transfers screen data between the CF card and the V7 series. (See page 6-11.)

Extension
 Indicates the driver setting and parameter setting for temperature controller/PLC2Way communication, ladder transfer function, Modbus slave communication, etc. (See page 6-27.)

RGB Adjustment
 Appears when the option unit EU-01 is provided. For more information, refer to the instruction manual for the EU-01 option unit.

I/O Test
 Checks the V7 series interface and performs a touch switch test. (See page 6-4.)

1. I/O Test

When the [I/O Test] switch on the Main Menu screen is pressed, the following "I/O Test" screen appears.

This screen is used to check that there is no problem with the V7 series interface and touch switch operation.

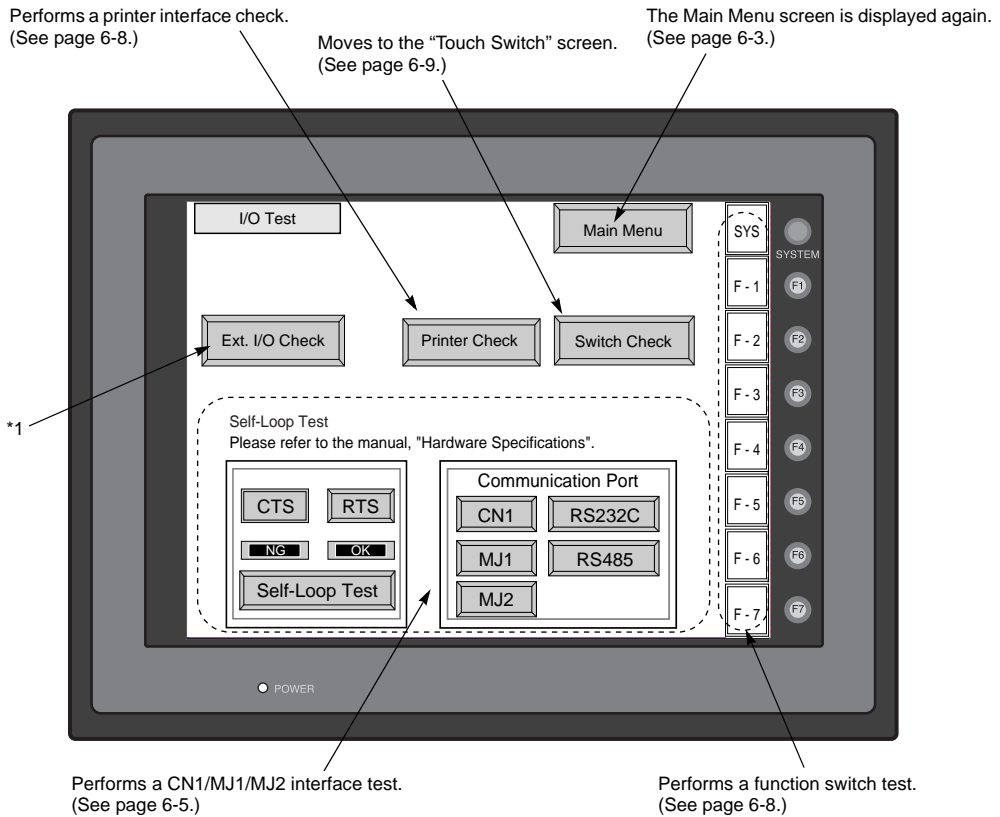

*1 When the serial extension I/O (V-I/O) is connected, use this button to check that the V-I/O works correctly. The [Ext. I/O Check] switch appears only when [V-I/O] is selected for a modular jack on the V-SFT editor.

1-1. Self-loop Test

This is a signal test for communications through the CN1, MJ1 or MJ2 connector. Perform this test if the communication is not successful when transferring screen data through MJ1, connecting the PLC using CN1, or selecting multi-link 2, temperature controller/PLC2Way or PLC for MJ1/2, or connecting the card recorder or serial extension I/O.

CN1: RS-232C Signal Test

Turn the [CN1] and [RS232C] switches on.

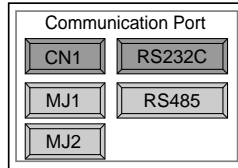

- SD/RD Test
Check the signals [SD] and [RD].
 1. Install a jumper between pins 2 and 3 of CN1 on the backside of the V7 unit.
 2. Press the [Self-Loop Test] switch. When the [OK] lamp lights up, the test is successfully completed.

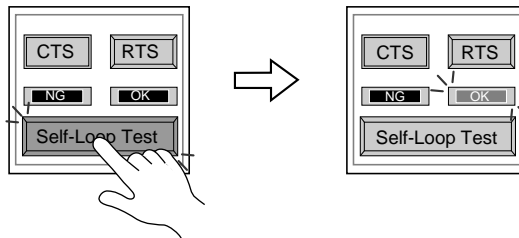

* If the [NG] lamp lights up, consult your local distributor.

- CTS/RTS Test
Check the signals [CTS] and [RTS].
 1. Install a jumper between pins 4 (RTS) and 5 (CTS) of CN1 on the backside of the V7 unit.
 2. Press the [RTS] switch and check that both [RTS] and [CTS] lamps light up at the same time. Press the [RTS] switch again and check that both [RTS] and [CTS] lamps go off at the same time.

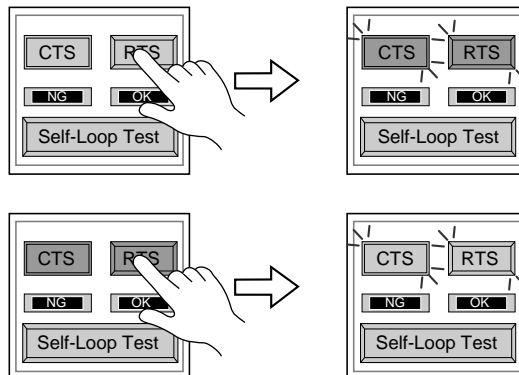

CN1: RS-485 Signal Test

Turn the [CN1] and [RS485] switches on.

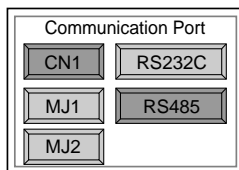

- SD/RD Test

Check the signals [SD] and [RD].

1. Install a jumper between pins 12 and 24 and between pins 13 and 25 of CN1 on the backside of the V7 unit.
2. Press the [Self-Loop Test] switch. When the [OK] lamp lights up, the test is successfully completed.

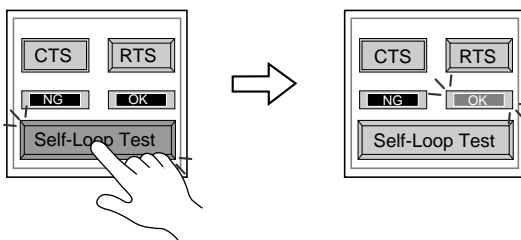

* If the [NG] lamp lights up, consult your local distributor.

- CTS/RTS Test

Check the signals [CTS] and [RTS].

1. Install a jumper between pins 14 (+RTS) and 19 (+CTS) of CN1 and between pins 17 (-RTS) and 18 (-CTS) on the backside of the V7 unit.
2. Press the [RTS] switch and check that both [RTS] and [CTS] lamps light up at the same time. Press the [RTS] switch again and check that both [RTS] and [CTS] lamps go off at the same time.

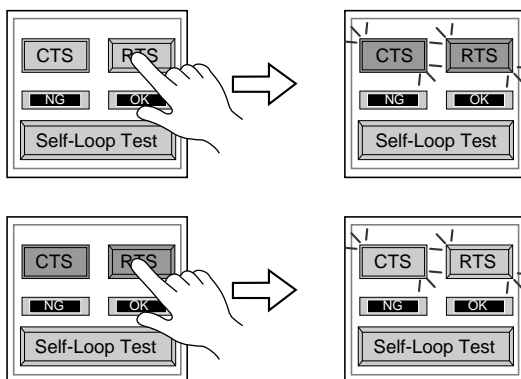

MJ1/2: RS-232C Signal Test

Turn the [MJ1] (or [MJ2]) and [RS232C] switches on.

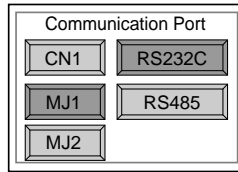

- RS-232C Self-loop Test
Check the signals [SD] and [RD].
Connect the data transfer cable (V6-CP) to CN1 for the test.

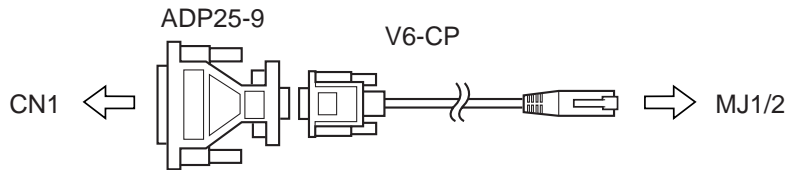

1. Set the adaptor ADP25-9 (attached to V6-CP) to the cable V6-CP. Connect the modular jack side of the cable to MJ1 (or MJ2) and the ADP25-9 side to CN1.
2. Press the [Self-Loop Test] switch. When the [OK] lamp lights up, the test is successfully completed.

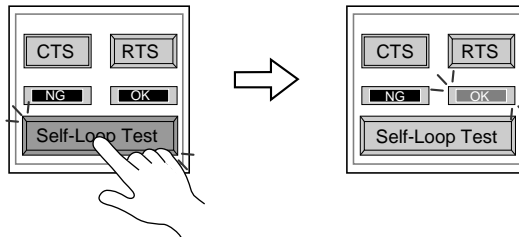

* If the [NG] lamp lights up, consult your local distributor.

MJ1/2: RS-485 Signal Test

If you would like to perform MJ1/2 RS-485 signal test, consult your distributor.

1-2. Print Check

Check that the V7 series transmits the signals to the printer correctly.

1. Connect the V7 unit to the printer.
2. Press the [Printer Check] switch. The test is successful when a test page is printed out without problem.

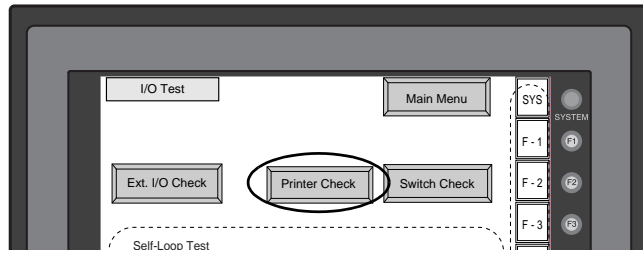

Example:

```

!#$%&@ 0123456789 ABCDEFGHIJKLMNO
!#$%&@ 0123456789 ABCDEFGHIJKLMNO
!#$%&@ 0123456789 ABCDEFGHIJKLMNO
!#$%&@ 0123456789 ABCDEFGHIJKLMNO
!#$%&@ 0123456789 ABCDEFGHIJKLMNO
!#$%&@ 0123456789 ABCDEFGHIJKLMNO
!#$%&@ 0123456789 ABCDEFGHIJKLMNO
  
```

1-3. SYSTEM & Function Switch Test

Check operations of eight switches provided vertically on the right side of the V7 panel. Press the switch, and check that the lamp on the screen lights up while the switch is held down.

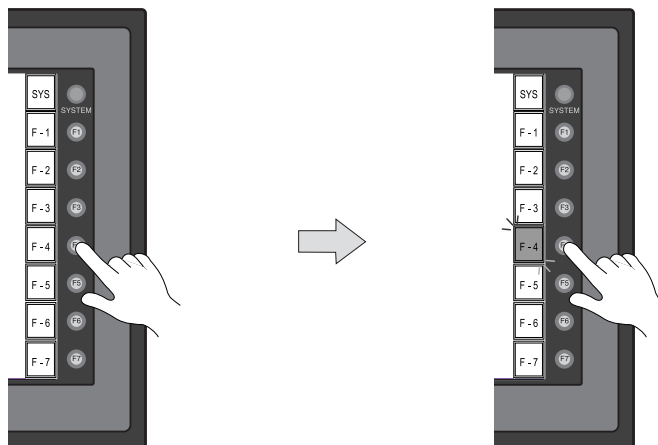

1-4. Touch Switch Test

If a touch switch does not activate at all or if an operation is performed without pressing any touch switch, check that the touch switches on the V7 panel are working properly.

1. Press the [Switch Check] switch. Grids appear on the screen as shown below.

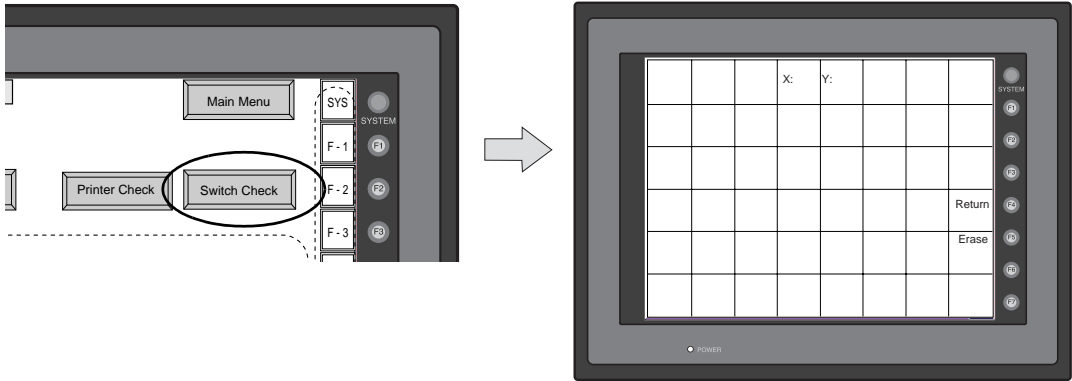

2. Press a position on the panel, and check that the pressed position turns white. The switch is activated normally when the pressed position turns white. To move back to the "I/O Test" screen, press the [F4] switch. To delete white dots press the [F5] switch.

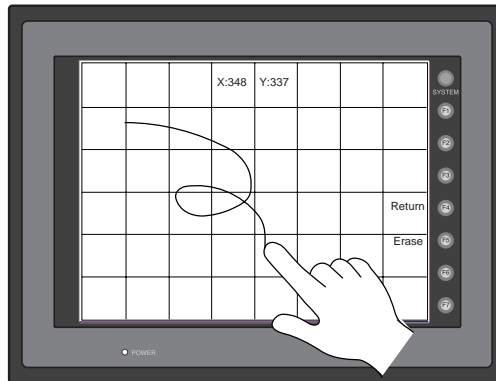

3. If a position different from the pressed position turns white, refer to "Touch Switch Adjustment" on the next page and adjust the touch switch position.

Touch Switch Adjustment

If a position different from the pressed position turns white on the touch switch test screen, follow the steps described below to adjust the touch switch position.

1. Hold down the [SYSTEM] switch and press the [F2] switch on the touch switch test screen.

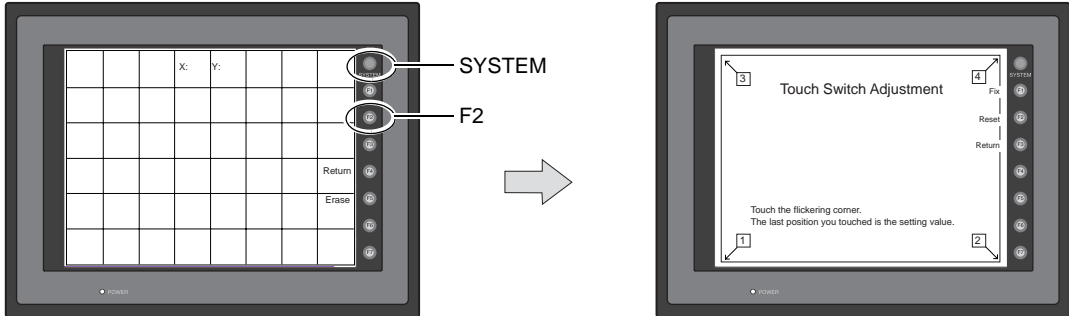

2. Press on "1" that is flashing at the corner on the touch switch adjustment screen. When the finger is released, a beep sounds and the position is set. "2" flashes.

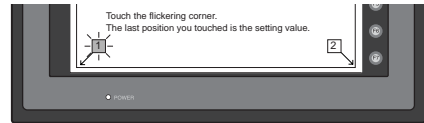

3. Press on "2" that is flashing at the corner. When the finger is released, a beep sounds and the position is set. "3" flashes.

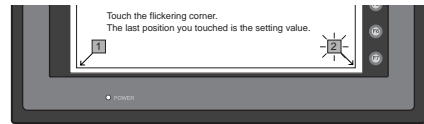

4. Press on "3" that is flashing at the corner. When the finger is released, a beep sounds and the position is set. "4" flashes.

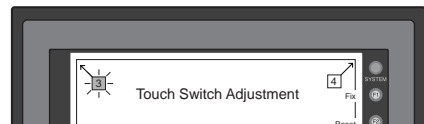

5. Press on "4" that is flashing at the corner. When the finger is released, a beep sounds and the position is set.

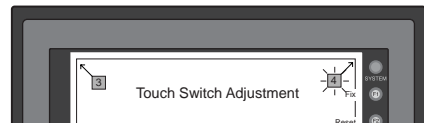

6. To re-set the positions, press the [F2] switch and follow step 2 and later.

7. Press the [F1] switch. A long beep sounds and the positions are determined. The touch switch test screen is displayed again.

8. To cancel the setting, press the [F3] switch. The touch switch test screen is displayed again.

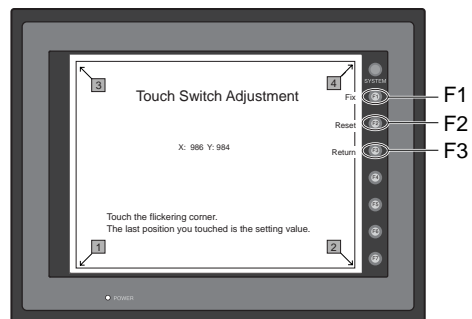

2. Card Menu Screen

When the [Card Menu] switch on the Main Menu screen is pressed, the following “Card Menu” screen appears.

This screen is used to transfer screen data between the V7 series and a CF card or a memory card.

Moves back to the Main Menu screen or the initial screen.

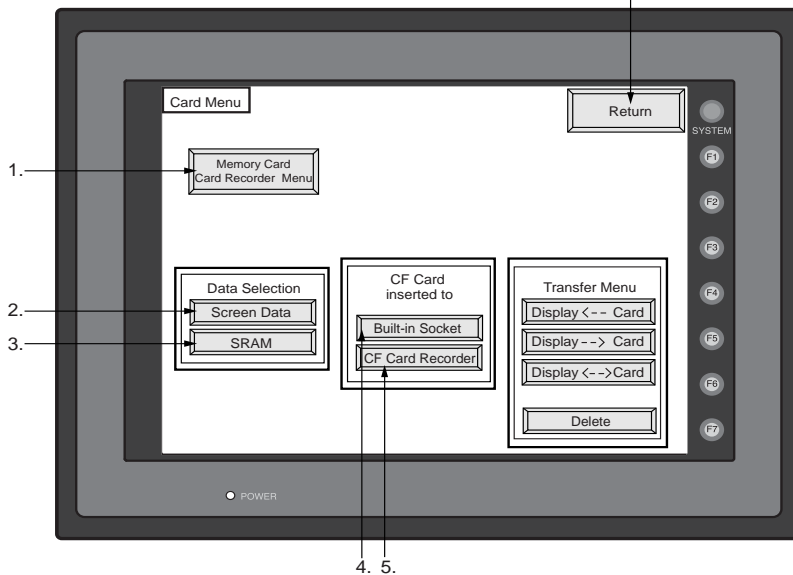

1. [Memory Card Card Recorder Menu] switch
Press this switch when connecting the card recorder to the MJ port of the V7 series and transferring screen data between the V7 series and a memory card.
2. [Screen Data] switch
Press this switch when transferring screen data between the V7 series and a CF card.
3. [SRAM] switch
Press this switch when saving backup copies of the SRAM memory or V7EM-S (SRAM cassette) or when uploading the backup data from the CF card to the V7 series.
4. [Built-in Socket] switch
Select the position where a CF card is inserted. Press this switch when inserting a CF card to the built-in socket.
5. [CF Card Recorder] switch
Select the position where a CF card is inserted. Press this switch when inserting a CF card to the CF card reader connected to the V7 series.

2-1. CREC Menu Screen

When the [Memory Card Card Recorder Menu] switch on the "Card Menu" screen is pressed, the following "Card Recorder Menu" screen appears. This screen is used to transfer screen data between the V7 series and a memory card. The procedure for transferring data is described below.

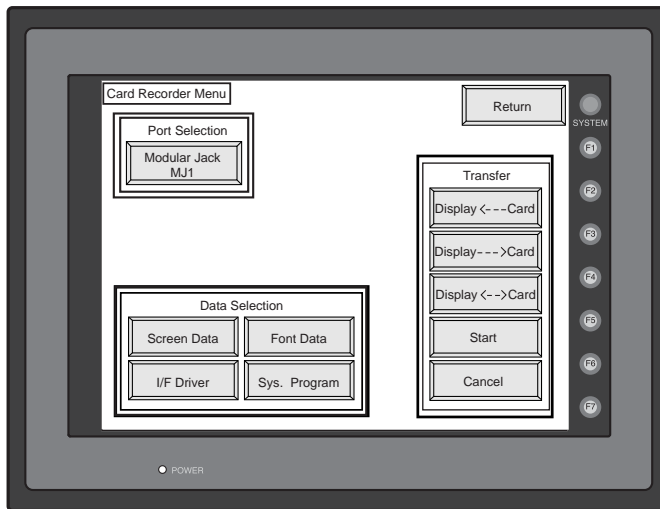

1. Connecting the CREC
 - Connect the CREC cable (CREC-CP) to the MJ port that is displayed in the "Port Selection" field.
 - MJ1:..... Connect the CREC to the MJ1 port. Normally MJ1 is selected.
 - MJ2:..... Connect the CREC to the MJ2 port. Only when [Memory Card] is selected for [Modular Jack 2], "MJ2" is indicated in the "Port Selection" field.
2. Mounting the Memory Card

Insert a memory card in to the card recorder (CREC).
3. Memory Card Information

Press the [Modular Jack MJ1 (MJ2)] switch.

The memory card information contained in the inserted memory card is indicated. Switches in the "Data Selection" field and "Transfer" field become active.

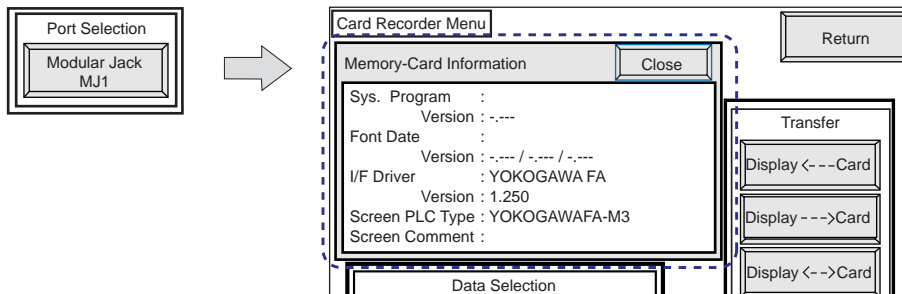
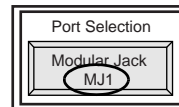

4. Data Selection and Transfer Selection

In the "Transfer" field, select [Display <-- Card], [Display --> Card] or [Display <--> Card]. Press the desired switch to turn the switch on. Multiple switches can be pressed in the "Data Selection" field.

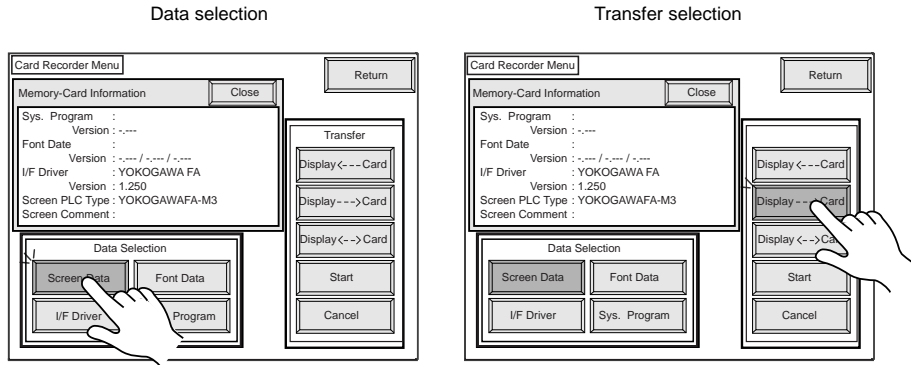

5. Starting Data Transfer

Press the [Start] switch. Data transfer is started. During data transfer, the [Start] switch changes into [Busy] and flashes. When data is transferred, the following message is displayed.

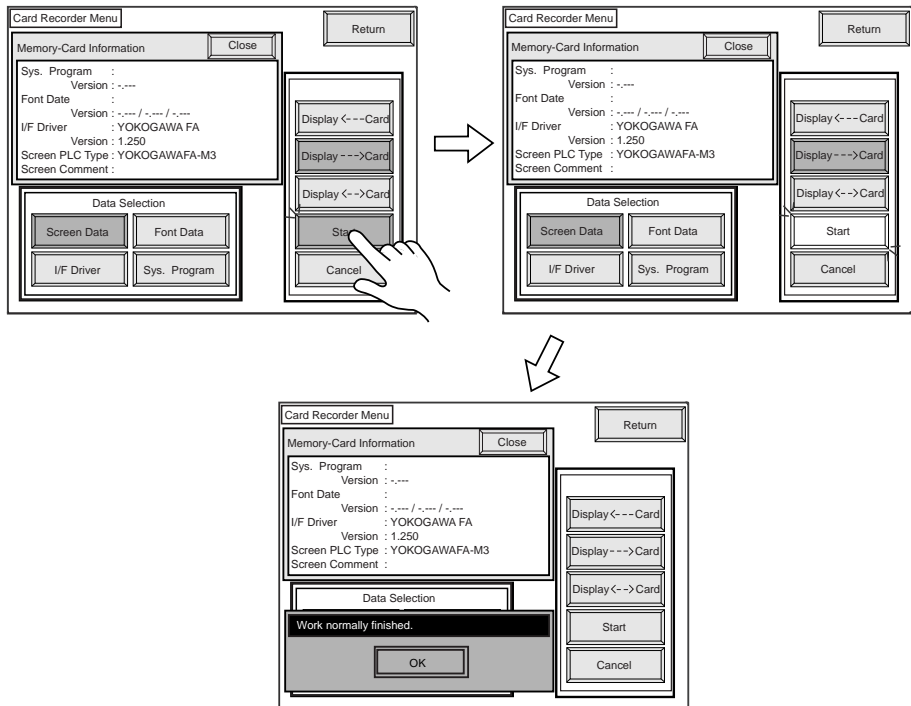

Press the [OK] switch.

6. Press the [Return] switch. The "Card Recorder Menu" screen is displayed again.

2-2. Transferring Screen Data from a CF Card

CF Card Folder Configuration

Folders in the CF card are configured as shown below.

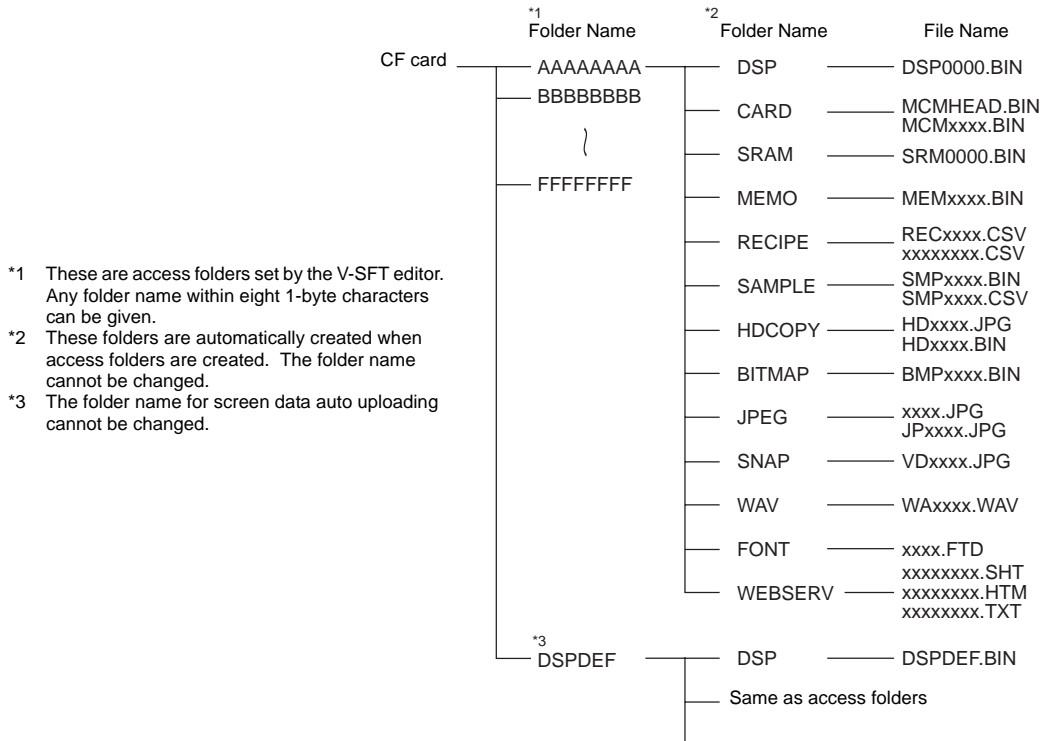

DAT0000 (access folder)

Folder Name	Contents	Folder Name	Contents
BITMAP	Saves pattern data (bitmap data) to reduce the screen data capacity.	RECIPE	Reads and writes recipe data.
CARD	Writes recipe data from the V7 series using the V6-compatible memory manager function.	SAMPLE	Saves history data of the data logging function.
DSP	Reads and writes screen data.	SNAP	Saves video snap images.
FONT	Saves Gothic fonts or language data to reduce the screen data capacity.	SRAM	Saves backup data of SRAM.
HDCOPY	Writes hard copy images in the JPEG file format from the V7 (V708 only: BIN file).	WAV	Saves WAV files for sound output to reduce the screen data capacity.
JPEG	Saves JPEG files for display on the screen (except for V708C).	WEBSERV	Saves files to be accessed from the Web browser.
MEMO	Saves memo pad data drawn with the V7 series.		

DSPDEF (screen data auto upload folder)

Folder Name	Contents
DSP	Automatically reads screen data in this folder when the CF card is inserted in the unit after the DIP switch is set.

(Other folders are the same as access folders.)

Transferring Screen Data from a CF Card

The procedure of transferring data between the V7 series and a CF card is described below.

1. Mounting the CF card
Insert the CF card into the CF card connector at the side of the V7 unit.
* Do not remove or insert the CF card in the later steps.
2. Data selection
Select [Screen Data]. When the lamp is red, it is selected.
3. Transfer selection
Select [Display <-- Card], [Display --> Card] or [Display <--> Card].

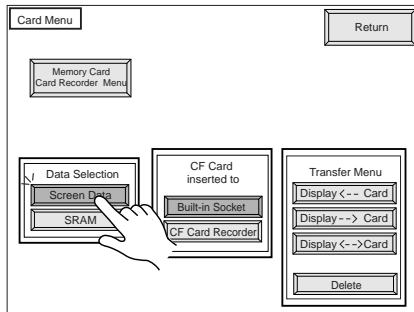

Data selection

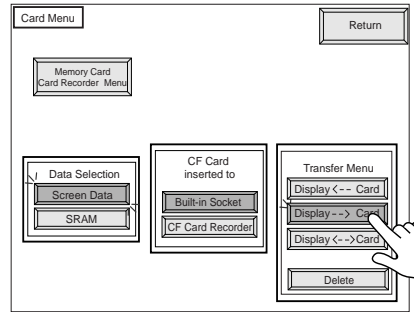

Transfer selection

When [Display <-- Card] is Selected:

Transfer screen data from the computer to the CF card.

1. When [Display <-- Card] is selected, the "Card Transfer" screen is displayed.

Flashes during communication with the CF card.

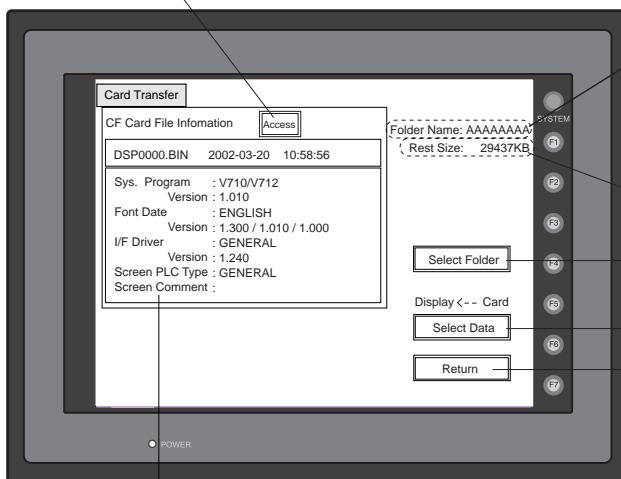

Indicates the name of the currently selected folder.
The access folder that is set for screen data defaults.
If there is no screen data, "DAT0000" defaults.

Indicates the free space in the CF card.

Used for checking or renaming folder names.

Starts transferring data [Display <-- Card].

Moves back to the previous screen.

Indicates the information of the currently selected folder.

2. Check the folder name, free space, and CF card file information. If the correct folder is selected, move to step 4.
 - Folder Name
Indicates the name of the currently selected folder.
The access folder that is set for screen data defaults.
If there is no screen data, "DAT0000" defaults.
 - Rest Size
Indicates the free space in the CF card.
 - CF Card File Information
Indicates the information of the currently selected folder.
3. To change to another folder, press the [Select Folder] switch.
The "Select Folder" screen is displayed.

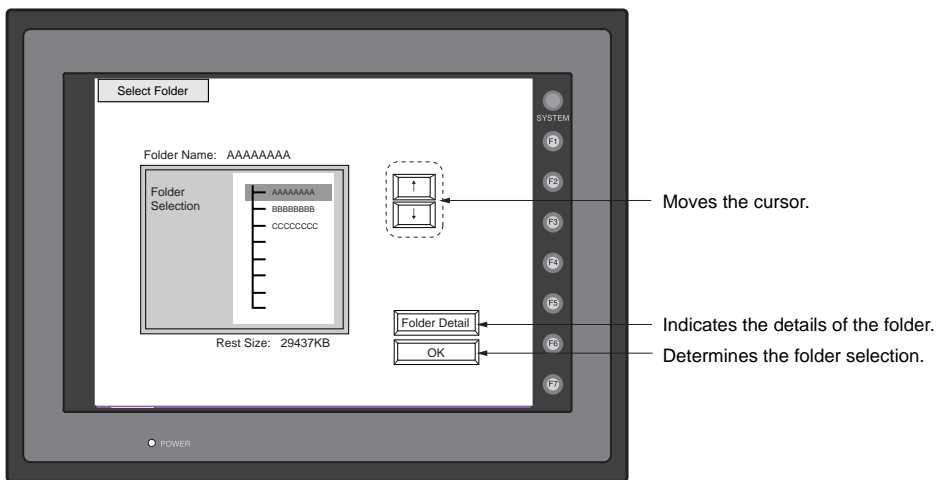

- To see the details of the folder, press the [Folder Detail] switch.
The "Folder Detail" screen is displayed.

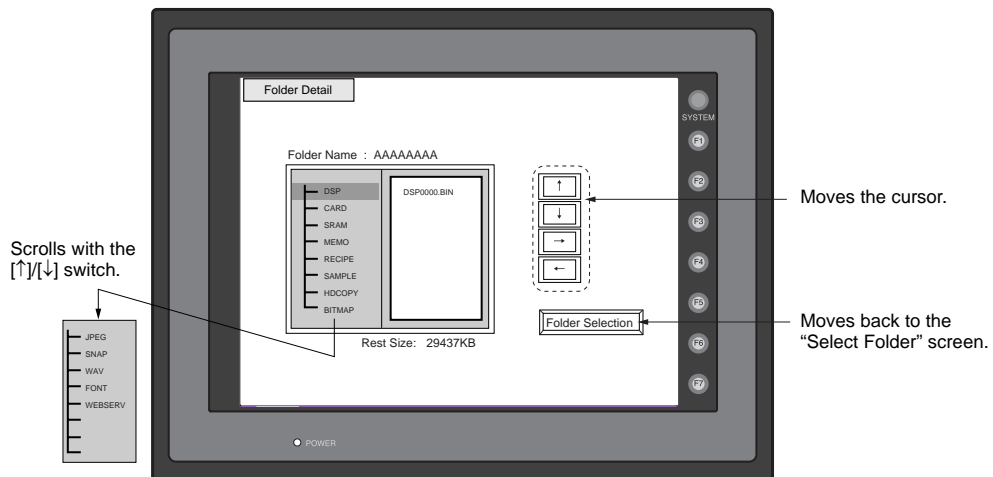

- [Select the desired folder using the [↑]/[↓] switch, and press the [OK] switch.
The Card Transfer screen is displayed again and the CF card file information of the selected file is indicated.

- Press the [Select Data] switch.

The [Data Selection] window is displayed and the [Select Data] switch changes to [Start].

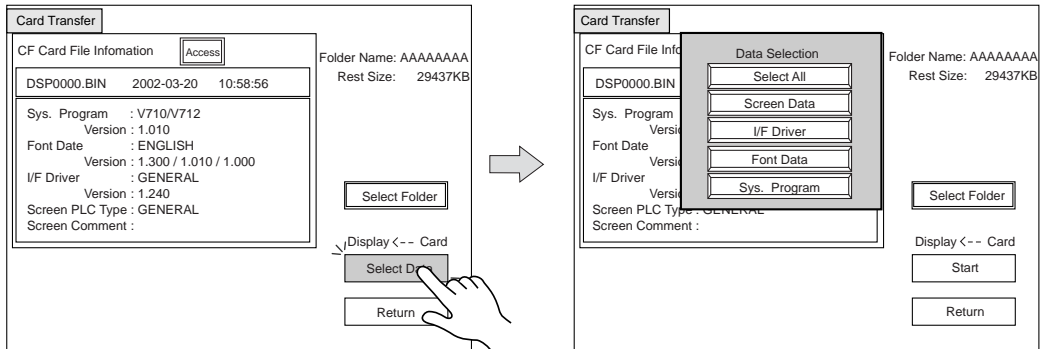

Select the desired data, and press the [Select Data] switch.

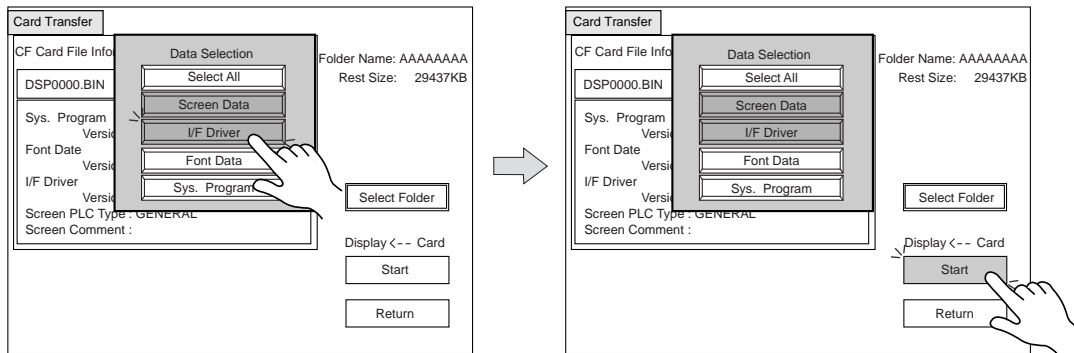

To cancel the [Data Selection] window, press the [Return] switch.

- During data transfer, the [Start] switch changes into [Busy] and flashes. When data has been transferred successfully, the following window is displayed. However, when [Sys. Program] or [Select All] is selected, the Main Menu screen is displayed without this message window on completion of data transfer.

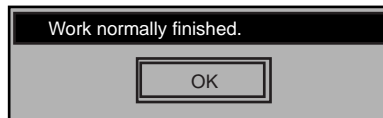

Press the [OK] switch.

The "Card Menu" screen is displayed.

If any other message is displayed, refer to page 6-22.

When [Display --> Card] is Selected:

1. When [Display --> Card] is selected, the "Card Transfer" screen is displayed.

Flashes during communication with the CF card.

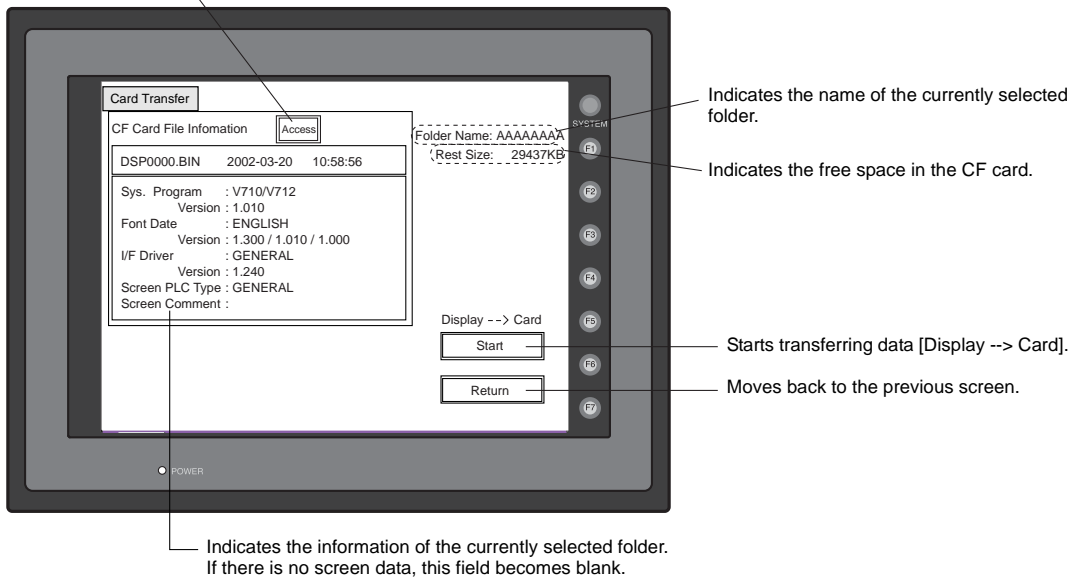

2. Check the folder name and CF card file information, and press the [Start] switch.

* When the access folder name of screen data is the same as that in the CF card, the CF card file information is indicated on the screen, and data in the MONITOUCH overwrites the CF card data. Note that the CF card data is lost when data is overwritten. When the CF card file information is blank, a new file "DSP0000.BIN" is created in the DSP folder.

3. During data transfer, the [Start] switch changes into [Busy] and flashes. When data has been transferred successfully, the following window is displayed.



Press the [OK] switch. The CF card file information shows data that has been transferred. If any other message is displayed, refer to page 6-22.

4. Press the [Return] switch. The "Card Menu" screen is displayed again.

When [Display <--> Card] is Selected:

- When [Display <--> Card] is selected, the "Card Transfer" screen is displayed. Screen data used for comparison is that in the DSP folder under the folder having the same name as the access folder that is set on the MONITOUCH.

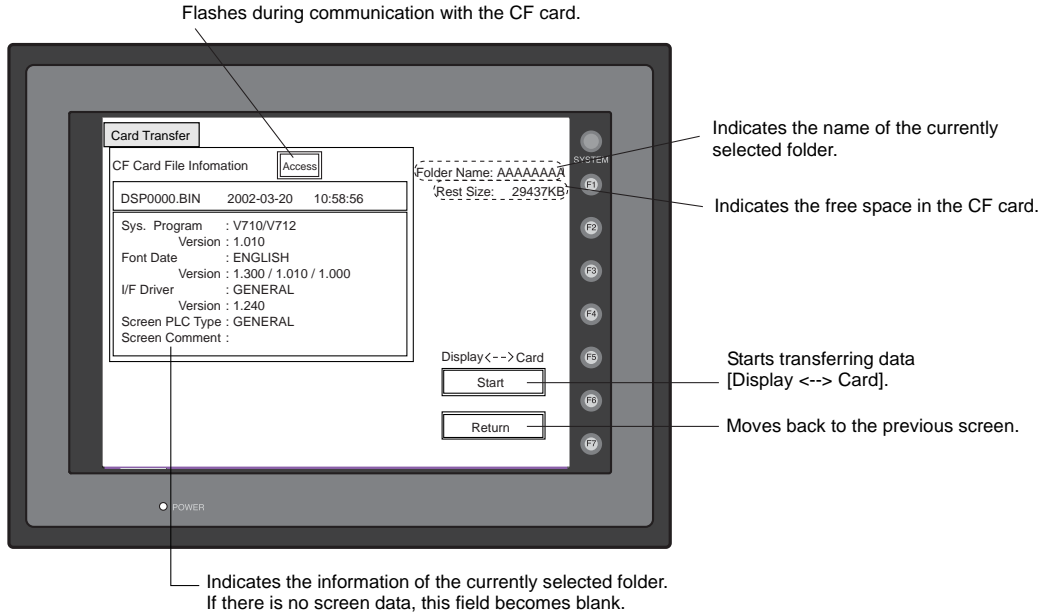

- Press the [Start] switch.
- During data transfer, the [Start] switch changes into [Busy] and flashes. When data has been transferred successfully, the following window is displayed.



Press the [OK] switch.

If any other message is displayed, refer to page 6-22.

- Press the [Return] switch. The "Card Menu" screen is displayed again.

2-3. Saving Backup Copies of SRAM

In this section, the procedure for saving backup copies of the SRAM memory in the MONITOUCH or V7EM-S (SRAM cassette) for battery replacement is explained.

1. Press the [SRAM] switch on the "Card Menu" screen. When the lamp is red, it is selected.
2. Select [Display <-- Card], [Display --> Card] or [Display <--> Card].

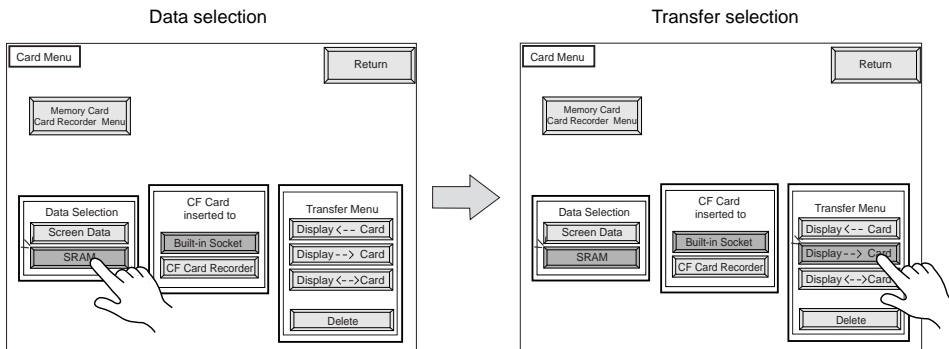

3. The "SRAM Transfer" screen is displayed.
 - When [Display --> Card] or [Display <--> Card] is selected, the following screen is displayed. Select the CF card folder having the same name as the access folder for screen data in the MONITOUCH. The name is shown on the screen. The transferred file is named as "SRM0000.BIN".

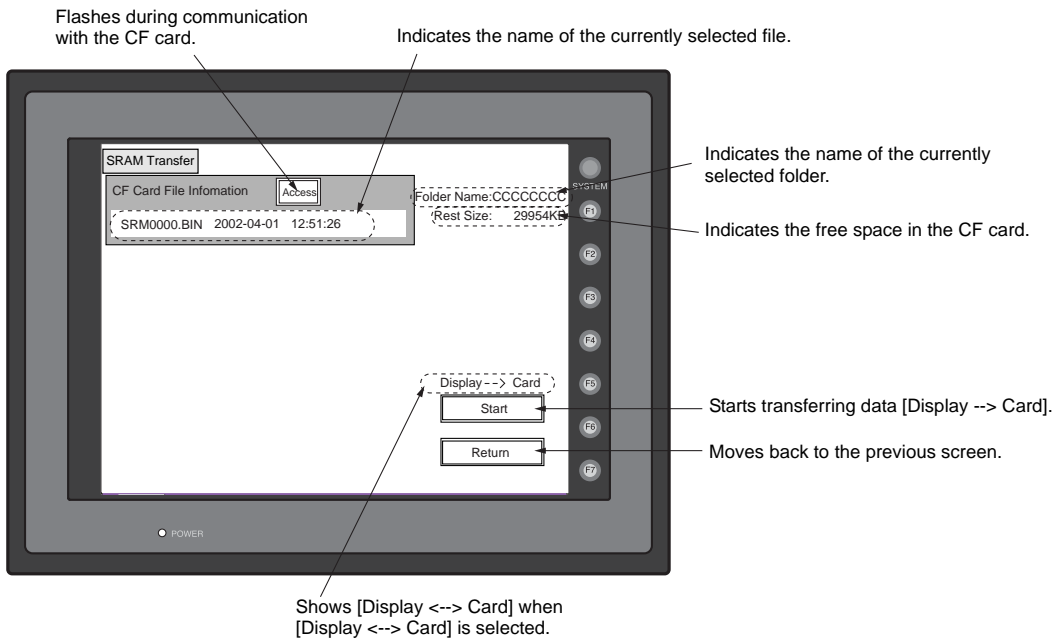

- When [Display <-- Card] is selected, the following screen is displayed.

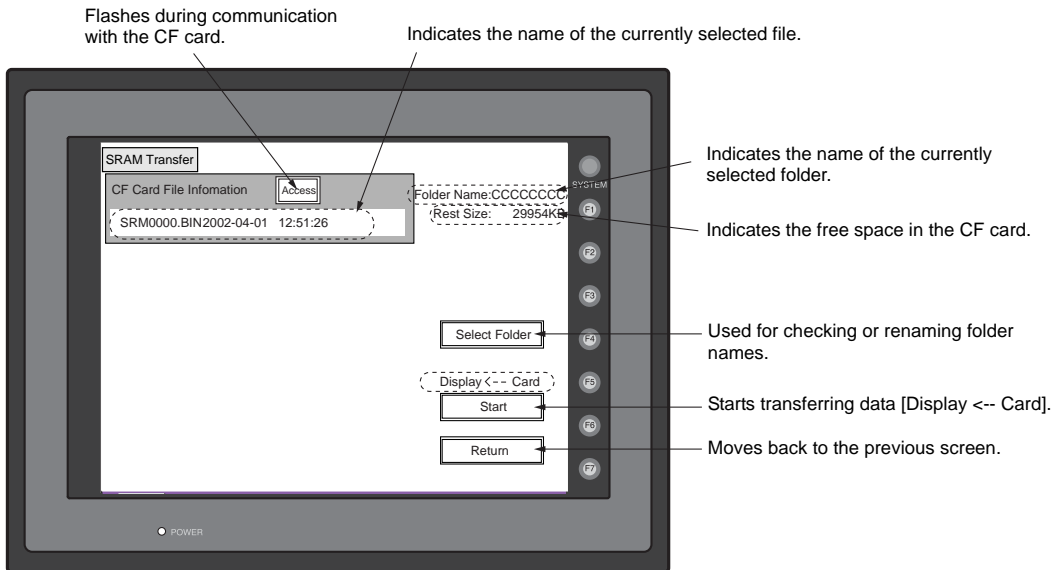

- 1) To change to another folder, press the [Select Folder] switch.
(The folder name must be "SRM0000.BIN".)
- 2) The "Select Folder" screen is displayed as shown on page 6-16.
Select the desired folder (refer to page 6-16), and press the [OK] switch.
- 3) Moves back to the "SRAM Transfer" screen.
4. Starting data transfer
Check the folder name, free space and transfer selection, press the [Start] switch.
Data transfer is started.
5. Ending data transfer
When data has been transferred successfully, the following window is displayed.

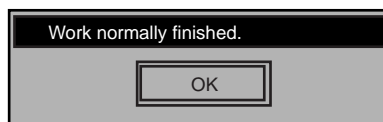

Press the [OK] switch.

If any other message is displayed, refer to the next page.

6. Pressing the [Return] switch moves back to the "Card Menu" screen.

2-4. Messages during Data Transfer

If an error occurs during data transfer, the message window shown on the right is displayed.

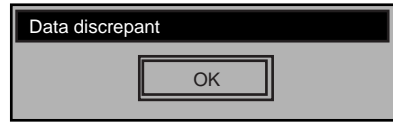

The kinds and the contents of the messages are shown below. The same messages are used for the memory card and CF card. When using the CF card, the "memory card" in the explanation should read as the "CF card".

Messages	Contents
Work normally finished.	The specified operation has been concluded normally.
CREC not connecting	No card recorder is connected when selecting a modular jack.
CREC Communication Error	A communication error occurred between V7 and CREC when selecting a modular jack.
Memory-Card not setting	Memory-Card not setting
Memory-Card Capacity over	Cannot write the data into a memory card because the data size in V7 is larger than the capacity of a memory card.
Write Protect: ON	Cannot write data into a memory card because the write protect switch in a memory card is ON.
Writing Error occurred.	The error occurred while writing data into a memory card.
Selected data does not exist.	The data in the reading target does not exist.
V7 type is different.	The specified type of the data in V7 is different from the type of the memory card data.
Selected data can not be read.	The data in a memory card cannot be read.
Reading Error occurred.	The error occurred during writing data into a flash ROM of V7.
Data discrepant	There is some discrepancy in data, when comparing data between a memory card and V7.
Screen data on V7 will be broken.	Warning about data destruction in V7 that may occur when transferring the font data larger than the present data from a memory card to V7. (The [OK] switch continues transferring; the [Cancel] switch stops transferring.)
Undefined Error occurred.	The error occurred due to some cause other than mentioned above.

3. Ethernet

* For more information on the IP address setting, refer to the V-SFT Additional Specifications Manual.

The "Ethernet" screen is displayed by pressing the [IP Address (English)] switch on the initial screen when transferring screen data via Ethernet for the first time, or by pressing the [Ethernet] switch on the Main Menu screen when transferring screen data to the MONITOUCH.

This screen is used for setting the IP address (a number that identifies the V7 series on the network) that is indispensable for Ethernet communications.

Depending on whether the LAN (100BASE-TX/10BASE-T) connector at V7i or the communication interface unit CU-03-2 for V7 is used, the "Ethernet" screen contents and the required settings vary as described below.

Connection with LAN (100BASE-TX/10BASE-T) Connector at V7i

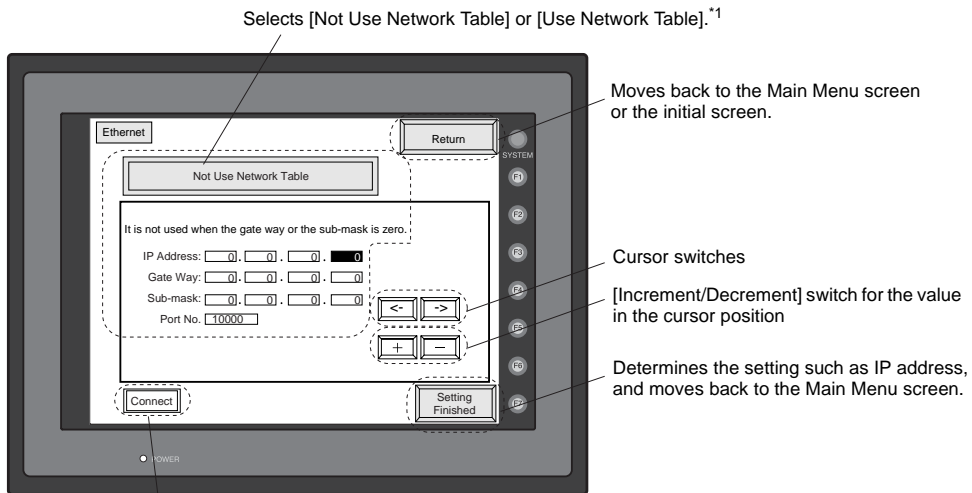

Used for checking the 100BASE-TX/10BASE-T interface.

Normal: Connect
Error: Disconnect

*1 Network Table

Register IP addresses and other information for the V7 series, PLCs or computers that should be included for Ethernet communications on the V-SFT editor.

([System Setting] → [Network Table Setting] → [Ethernet] → Edit Network Table)

The registered network table can be used or not used depending on the [Not Use Network Table/Use Network Table] switch.

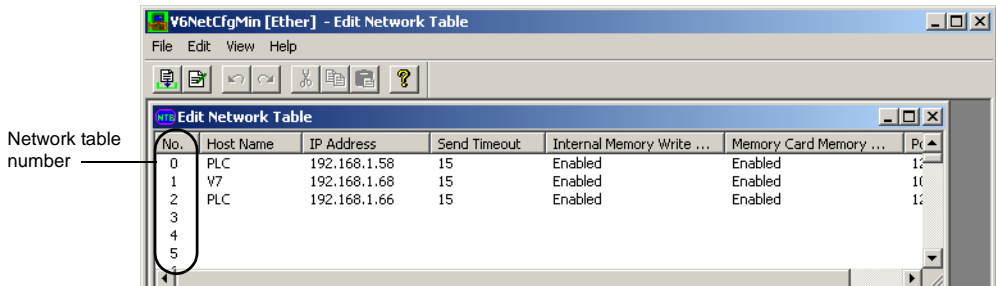

Not Use Network Table

In the following cases, select [Not Use Network Table].

- Screen data is transferred for the first time via Ethernet.
- The network table is not set for screen data of the V7 series.
- If the network table is set for screen data of the V7 series but you would like to use an IP address that is different from that set on the network table tentatively, press the [Use Network Table] switch to select [Not Use Network Table].

When the network table is not set or is not used

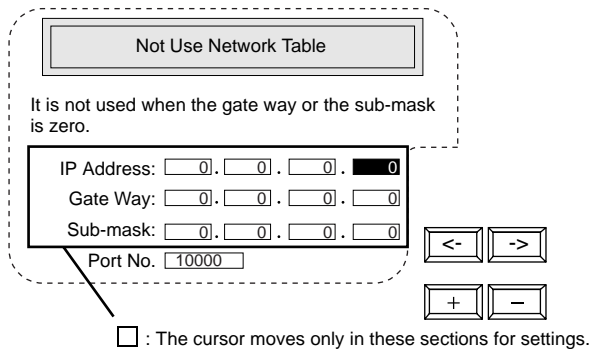

1. Set the IP address.
(If necessary, set the default gateway and subnet mask.)
2. Press the [Setting Finished] switch. The IP address is determined.
3. The Main Menu screen is displayed again. (If the "Ethernet" screen is displayed from the initial screen, the initial screen is displayed again.)

Use Network Table

In the following cases, select [Use Network Table].

- The network table is set for screen data of the V7 series and you would like to change the network table number.

When the network table is used:

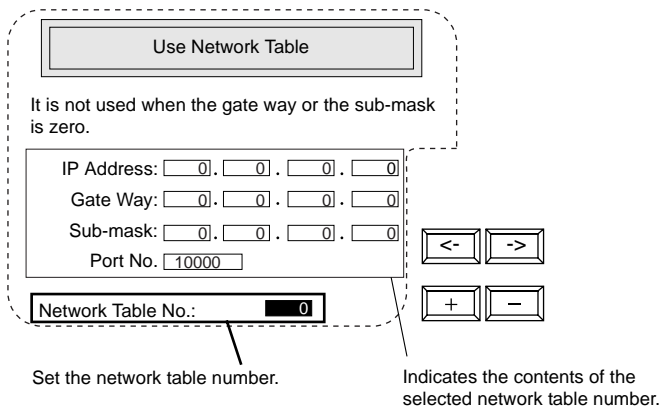

1. Set the network table number.
2. Press the [Setting Finished] switch. The IP address is determined.
3. The Main Menu screen is displayed again.

Connection with CU-03(-2) on V7

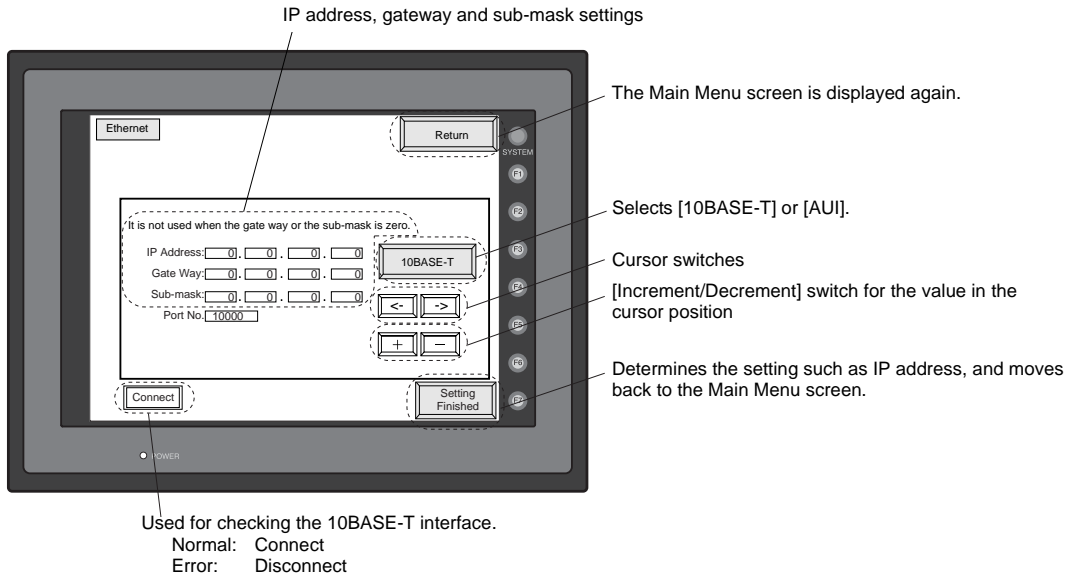

1. Select either [10BASE-T] or [AU] for the connecting method.
 2. Set the IP address.
(If necessary, set the default gateway and subnet mask.)
 3. Press the [Setting Finished] switch. The settings are determined.
 4. The Main Menu screen is displayed again.
- Rotary Switch and Network Table
Register IP addresses and other information for the V7 series, PLCs or computers that should be included for Ethernet communications on the V-SFT editor.
([System Setting]→[Network Table Setting]→[Ethernet]→[Edit Network Table])
Set the network table number with the rotary switch on the communication interface unit CU-03(-2).

Port number to be set with the rotary switch on the communication interface unit CU-03(-2)

No.	Host Name	IP Address	Send Timeout	Internal Memory Write ...	Memory Card Memory ...	Pk
0	PLC	192.168.1.58	15	Enabled	Enabled	1:
1	V7	192.168.1.68	15	Enabled	Enabled	1:
2	PLC	192.168.1.66	15	Enabled	Enabled	1:

4. SRAM/Clock

- To use the built-in clock of the V7 series or to use the SRAM memory or cassette, it is necessary to select [SRAM/Clock Setting] from the [System Setting] menu and make the SRAM/clock setting. To use the Japanese FEP function, it is necessary to check [Use Japanese FEP Function] in the [System Setting] menu of V-SFT. For the setting procedure, refer to the Reference Manual.
- Be sure to set the battery when using the built-in clock of the V7 series, the SRAM memory or the Japanese FEP function. Without battery, the contents in the SRAM or clock data will not be retained. When the battery is not connected, the message "Battery not set" is displayed and the [SRAM/Clock] switch flashes on the [Main Menu] screen. Connect the battery immediately. When the battery is to be replaced, the message "Brownout Battery" is displayed.

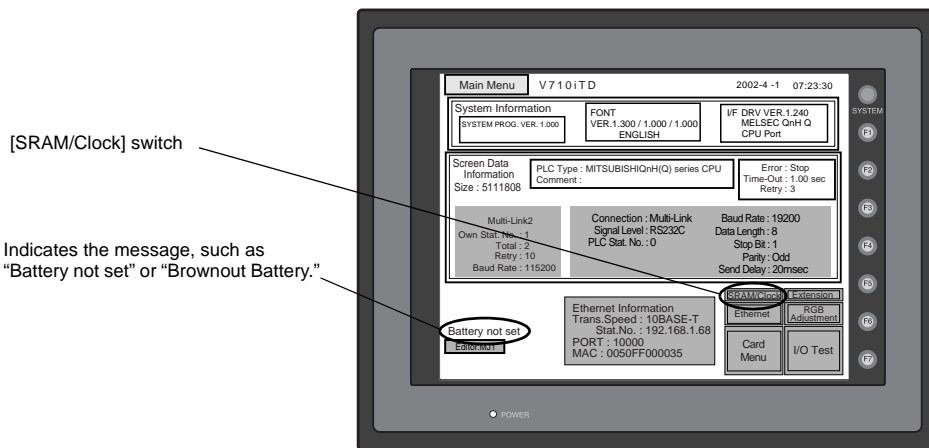

- When the [SRAM/Clock] switch on the Main Menu screen is pressed, the following "SRAM/Clock Adjustment" screen appears. This screen is used for adjusting the built-in calendar, for initializing the SRAM area and for clearing the Learning/User Phrase Area on the Japanese FEP function.

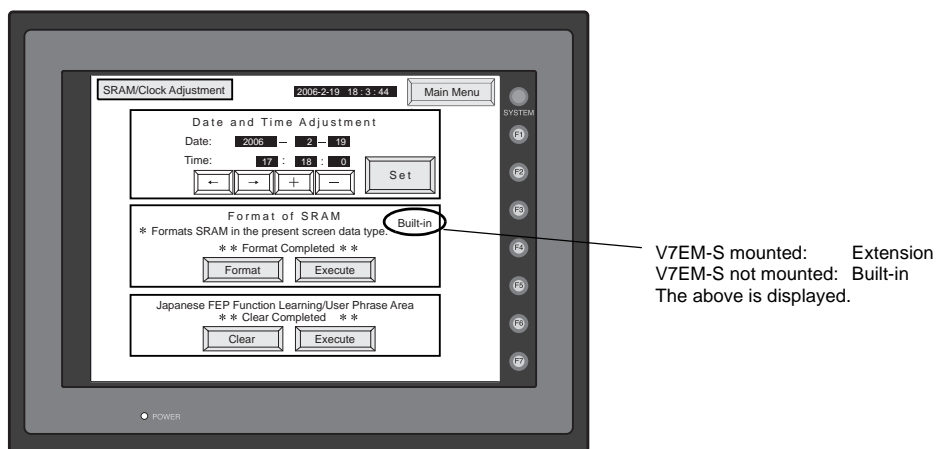

Date and Time Setting

1. Move the cursor using the [←] / [→] switch, and change the value by pressing the [+] / [-] switch.
2. When the desired date and time are set, press the [Set] switch to determine the setting.
3. The calendar data is updated as set.

Initializing SRAM

When the SRAM memory or cassette is initialized, the data contained is cleared. Double-check before initializing the SRAM memory or cassette.

1. "Extension" is shown when V7EM-S (SRAM cassette) is mounted; "Built-in" is shown when it is not mounted.
2. Press the [Format] switch and the [Execute] switch.
The SRAM area is initialized in the current screen data format. When initialization has been completed, the message "**Format Completed**" is displayed.

Japanese FEP Function

When the Learning/User Phrase Area is cleared, the registered data is cleared. Check if the data may be cleared carefully before initializing the Learning/User Phrase Area.

1. Press the [Clear] switch and the [Execute] switch.
2. When initialization has been completed, the message "***Clear Completed**" is displayed.

5. Extension Program Information

When the [Extension] switch on the Main Menu screen is pressed, the following "Extension Program Info." screen appears.

The driver setting and parameter setting for temperature controller/PLC2Way communication, ladder transfer function, Modbus slave communication, etc. are displayed.

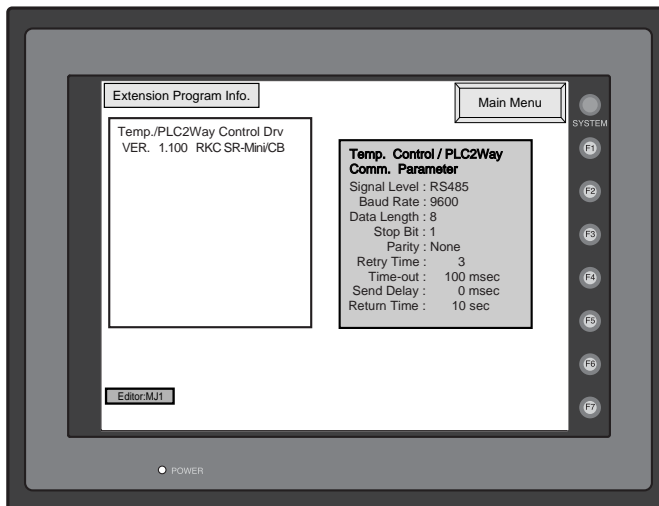

6. Extended Function Setting

When the [Editor: MJ1] switch and the [F5] switch on the Main Menu screen is pressed at the same time, the following “Extended Function Setting” screen appears.

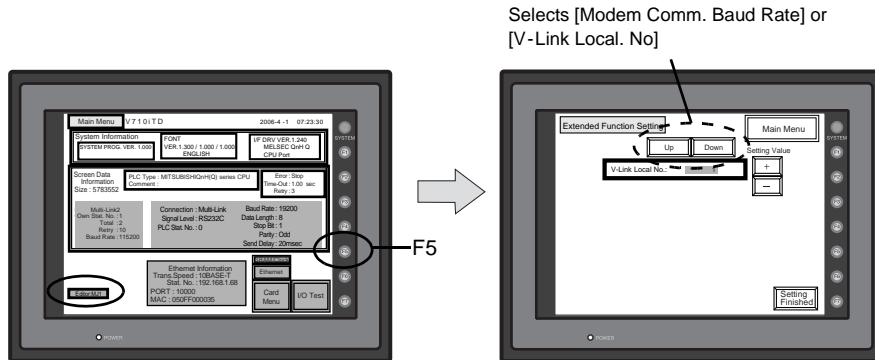

Set the Modem Comm. Baud Rate

Set the baud rate to be used when transferring screen data between the V7 series and a modem.

1. Select the desired baud rate using the [↑] / [↓] switch, and press the [Setting Finished] switch. (Setting range: 4800, 9600, 19200, 38400, 57600, 115200)
 - * The function switches and switches on the Main Menu screen are not valid for 15 seconds after the [Setting Finished] switch is pressed.
 - * When the [Setting Finished] switch is pressed, an AT command is automatically sent to the modem and the baud rate used between the V7 and the modem is set.
2. The [Main Menu] (local main) screen is displayed automatically. [Modem Connect Mode] automatically appears under [Editor: MJ1].
3. To transfer screen data without a modem, select “Not used” for [Modem Comm. Baud Rate]. For screen data transfer while a computer is connected with V6-CP, specify [Not Used] for [Modem Comm. Baud Rate].

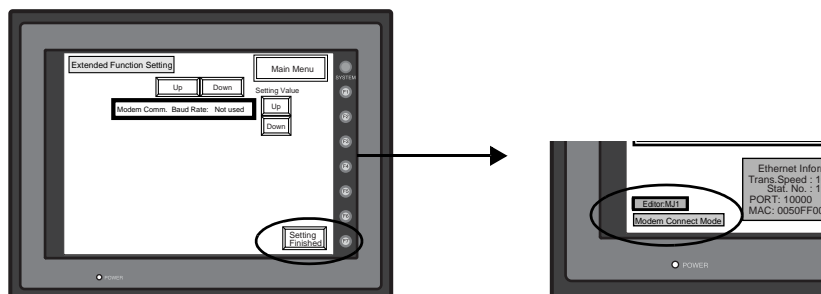

Pressing the [Setting Finished] switch moves back to the Main Menu screen.

Set the V-Link Local No.

The local No. of V-Link can be specified in the [Main Menu].

1. Check [Set Local No. in Main Menu.] of the [V-Link Setting] in the [System Setting] menu, and transfer the screen data.
2. In this [Extended Function Setting] screen, switch to change [Modem Comm. Baud Rate] to [V-Link Local No.].

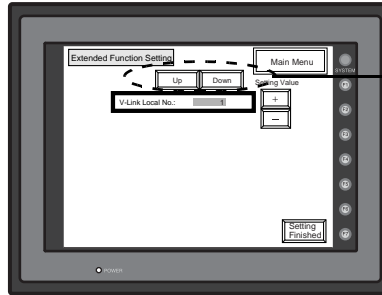

Pressing the [Down] switch moves to the [V-Link Local No.] item.

3. Specify the local No. by using the [Up] / [Down] switch in the "Setting Value" and press the [Setting Finished] switch. (Setting range :1 to 254)
4. The [Main Menu] screen is displayed automatically.

MEMO

Please use this page freely.

7 Error Correction

1. Error Messages
2. Troubleshooting

1. Error Message

There are five kinds of error messages displayed on the V series:

1. Communication error
2. Check
3. Warning
4. SYSTEM ERROR
5. Touch switch is active

1. Communication Error

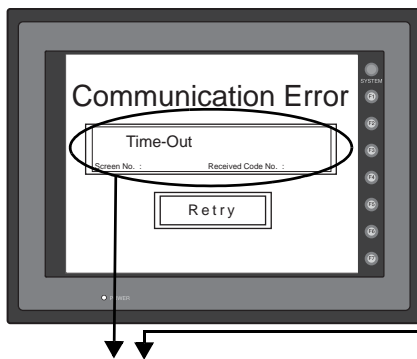

* When you go to [Comm. Parameter], bring up the [Detail] tab window and set [Continue] for [Comm. Error Handling], a screen like the one shown below is displayed.

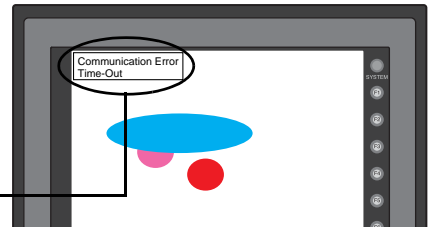

Error Message	Contents	Solution	Remarks
Time-Out	Although a request to send is given to the PLC, no answer is returned within the specified time.	1. Check the communication parameters.	1
		2. Check the cables and wiring.	
		3. Data may be disrupted because of noise. Fix noise.	2
Parity	An error occurred in parity check.	1. Check the cables and wiring.	1
		2. Data may be disrupted because of noise. Fix noise.	2
Framing	Although the stop bit must be [1], it is detected as [0].	1. Check the communication parameters.	1
		2. Check the cables and wiring.	
Overrun	After one character is received, the next character is received before internal processing is completed.	3. Data may be disrupted because of noise. Fix noise.	2
		1. Check the communication parameters.	1
Check Code	The check code in the PLC response was not correct.	2. Data may be disrupted because of noise. Fix noise.	2
		1. Check the communication parameters.	1

* If the above error messages are displayed on the V7 without establishing communication between V7 and PLC, test the solution of remark "1."
If the error occurs suddenly in communication, test the solution of remark "2."

Error Message	Contents	Solution
Error code received	The PLC sent an error code (NAK).	Examine the CPU error code and solve the problem.
Break	The PLC's SD (TXD) remains at the low level.	Examine the connection between the PLC's SD (TXD) and the V series RD (RXD).
Invalid memory (applicable to MITSUBISHI CPU)	You specified an address that exceeds the memory range of the PLC that you are linked to.	Check the type and range of memory that you set.
Invalid CPU model (applicable to MITSUBISHI CPU)	The PLC currently being supported does not have a corresponding CPU.	Confirm whether or not the CPU that you are using can be used with the V series.
Format	The code of the received data is invalid.	Check 1, 2, 3 described below.
Compare (applicable to HIDIC S10)	Transmission data and received data are different.	Check 1, 2, 3 described below.
NAK	A NAK code is received.	Check 1, 2, 3 described below.
TNS discrepant (applicable to Allen-Bradley PLC)	Transmitted TNS data and received TNS data are not in agreement.	Check 1, 2, 3 described below.
Communication Error	An unclear communication error is detected.	Check 1, 2, 3 described below.
Count error (applicable to MITSUBISHI CPU and Q link unit)	The expected data amount is different from the count value.	Check 1, 2, 3 described below.
Command error (applicable to MITSUBISHI CPU and Q link unit)	The response code differs from the expected code.	Check 1, 2, 3 described below.
Invalid cassette (applicable to MITSUBISHI ACPU)	This cassette is not included in the memory cassettes currently being supported.	Contact your local distributor.
Password error (applicable to MITSUBISHI QCPU)	The password is incorrect.	Contact your local distributor.

Solution

1. Confirm link unit settings.
(After making settings, cut power to the PLC.)
2. Go to the editor (V-SFT) and confirm the settings in the [Comm. Parameter] dialog in the [System Setting] menu.
3. If errors only occur from time to time, it is possible that there is a noise-based communication error.
* If you still cannot solve the error even after following the suggestions above, contact your local distributor.

Error Messages for Network Communication

• Ethernet

Error Message	Contents	Solution
Ethernet Error: XXXX	The Ethernet status is saved at system memory address \$s518 and a code other than "0" (normal) is received. XXXX: Error No.	For the contents and solution to each error number, refer to Appendix 5 of the PLC Connection Manual separately provided.

• MELSECNET/10

Error Message	Contents	Solution
I/F Board Err	The I/F unit for NET/10 has an error.	Contact your local distributor.
Request Code Err	The request command from NET/10 has an error.	
Request Data Err	The request data from NET/10 has an error.	
Word Writing to Sp. Relay (MITSUBISHI: A Series)	Word writing to a special relay (M9000 and later) is attempted. (Notes: Only bit writing is possible for special relays when connecting with NET/10.)	Do not attempt to perform word writing to special relays.

- CC-LINK

Error Message	Contents	Solution
I/F Board Err	The I/F unit for CC-LINK has an error.	Contact your local distributor.
No. of Occupy Setting Err	The number of occupy in [Comm. Parameter] is different from the number of occupy by switches.	Check the setting of the number of occupy.
Network I/O Access Err	MONITOUCH is about to access exceeding the set number of input/output words.	Check the memory for the network I/O in the screen data file.
Station Number Err	The port number set by a switch is not within the setting range (1 to 64).	Specify the port number within the setting range.
Word Writing to Sp. Relay	Word writing to a special relay (M9000 and later) is attempted. (Notes: Only bit writing is possible for special relays when connecting with CC-LINK.)	Do not attempt to perform word writing to special relays.

- OPCN-1

Error Message	Contents	Solution
I/F Board Err	The I/F unit for OPCN-1 has an error.	Contact your local distributor.
Stat. No. out of range	The port number set by a switch is not within the setting range (1 to 127).	Specify the port number within the setting range.
Network Link Error	Cannot connect to the master station in the network.	Check the condition of the master station (PLC). Check the network connection.
Network I/O Access Err	MONITOUCH is about to access exceeding the set number of input/output words.	Check the memory for the network I/O in the screen data file.
Waiting for Reply	1. Less than "Max_int" time (communication monitoring time for salve station) set on the PLC for OPCN-1 communications 2. Timeout on the V-SFT editor (The timeout time can be set from [System Setting] → [Comm. Parameter] on the V-SFT editor.) This error is indicated when the above 1 and 2 are present.	When the "Max_int" time is too long (infinite, for example) on the PLC, it is not possible to know whether or not the response from the PLC is correctly made. This error message disappears when a response from the PLC is received within the "Max_int" time.
Word Writing to Sp. Relay (MITSUBISHI: A Series)	Word writing to a special relay (M9000 and later) is attempted. (Notes: Only bit writing is possible for special relays when connecting with OPCN-1.)	Do not attempt to perform word writing to special relays.

- T-LINK

Error Message	Contents	Solution
T-LINK I/F Board Err	The I/F unit for T-LINK has an error.	Contact your local distributor.
Network I/O Access Err	MONITOUCH is about to access exceeding the set number of input/output words.	Check the memory for the network I/O in the screen data file.
Access denied by Loader	The PLC loader is being accessed so that processing is not performed on V7. (This error occurs during program transfer from the PLC loader for most cases.)	Wait for the PLC loader to finish processing, and press the [RETRY] switch on the V7 screen.
Communication Error Received Code No. 32	An attempt to access an area that does not exist within the PLC is made. Example: A file area (W) that is not defined with the PLC program	Check the PLC memory addresses set in the screen data file.
Communication Error Received Code No. 36	The number of monitor registration points is too small.	Correct the number of monitor registration points. For monitor registration, refer to the user manual of the PLC you are using.

- PROFIBUS-DP

Error Message	Contents	Solution
Time-Out	"Check" is displayed 2 or 3 seconds before this error occurs when connecting V7 and PROFIBUS-DP in the RUN mode.	The setting for [Own Stat. No.] on V7 is discrepant with that for [Address] for [V7 series] on the SIMATIC Manager. Check and correct the setting.
	A screen is displayed instantaneously (= communications performed) before this error occurs when connecting V7 and PROFIBUS-DP in the RUN mode.	The DB address set on the V7 screen may not exist on the PLC (memory over). Check the setting.

• DeviceNet

Error Message	LED		Contents	Solution
	MS	NS		
Initialization Error	● Red	○	Reading or writing to RAM is not performed normally during initialization check.	<ul style="list-style-type: none"> Turn the power on again. If recovery is not possible, a fault is suspected.
			Start-up information check error: The baud rate is outside the specified range.	<ul style="list-style-type: none"> Make the baud rate (using DIP switch 7 and 8) the same as set for the master and turn on the power again. If recovery is not possible, a fault is suspected.
			Start-up information check error: Excessive size for input	<ul style="list-style-type: none"> On the V-SFT, go to the [Comm. Parameter] dialog. In the [No. of Words Setting for I/O] tab window, enter the desired value of up to 128 words for [Input Range]. Then turn on the power again.
			Start-up information check error: Excessive size for output	<ul style="list-style-type: none"> On the V-SFT, go to the [Comm. Parameter] dialog. In the [No. of Words Setting for I/O] tab window, enter the desired value of up to 128 words for [Output Range]. Then turn on the power again.
BUS OFF Error	● Green	● Red	<ul style="list-style-type: none"> The communication cable is short-circuited at start-up. The baud rate does not match the setting for the master. 	<ul style="list-style-type: none"> Check the wiring and turn on the power again. Make the baud rate (using DIP switch 7 and 8) the same as set for the master and turn on the power again.
Node Address Duplication Error	● Green	● Red	The same node address is already used for the master or some other slave.	<ul style="list-style-type: none"> Check the node address and correct it to an address which is not used yet (using DIP switch 1 to 6). Then turn on the power again.
Network Error	● Green	○	The network power is off.	<ul style="list-style-type: none"> Turn on the network power supply.
			No other devices exist on the network.	<ul style="list-style-type: none"> Check the wiring and turn on the power again. Make the baud rate (using DIP switch 7 and 8) the same as set for the master and turn on the power again.
		⊙ Red	I/O time-out: Communication with the master has become disabled.	<ul style="list-style-type: none"> Check the conditions of the master power supply. Check the wiring.
		⊙ Green	No connection exists.	<ul style="list-style-type: none"> Check the wiring.
Definition Error	-	-	The returned error code is not supported by the DeviceNet.	Review the settings below: <ul style="list-style-type: none"> Master setting CU-07 setting V-SFT setting Wiring

: Extinguished : Illuminated : Blinking

* Depending on the errors detected, turning on the power again may be necessary on the master as well as on the V series.

2. Check

Error Message	Contents	Solution
Screen No. Error	There is no setting for the received screen.	At the start of communications, the V7 series regards the value in the read area "n + 2" as the screen number. Check that the value in the read area "n + 2" is an existing screen number on the PLC.
Data has some error. Error : XX (XX : XXX)	There is an error in the created screen data.	"Error : XX (XX : XXX)" indicates the edited screen and the contents of the error. For the error details and solutions, refer to the Reference Manual (Function) and correct screen data.

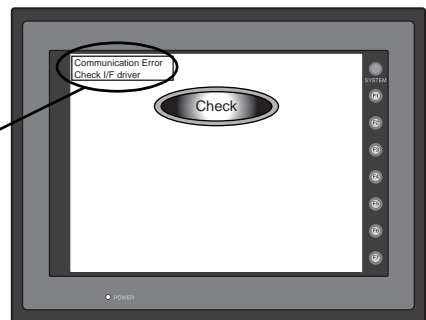
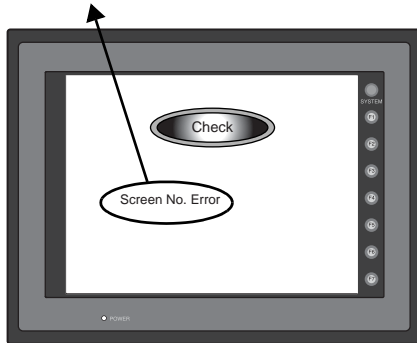

Error Message	Contents	Solution
Communication Error Check I/F driver	Although a request to send is given to the computer, no answer is returned within the specified time.	The I/F driver for simulator is transferred. If you do not use the simulator, uncheck [Use Simulator] before transferring data.

3. Warning

An error may be displayed on the Main Menu screen during data transfer.

This is a warning message.

For the warning details and solutions, refer to the Reference Manual (Function) and correct screen data.

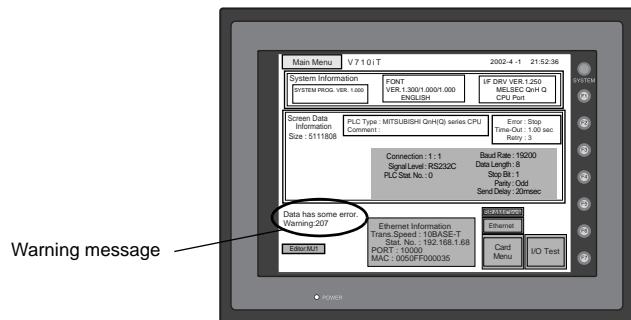

4. SYSTEM ERROR

When a system error is detected, the following error screen is displayed on the V7 series.

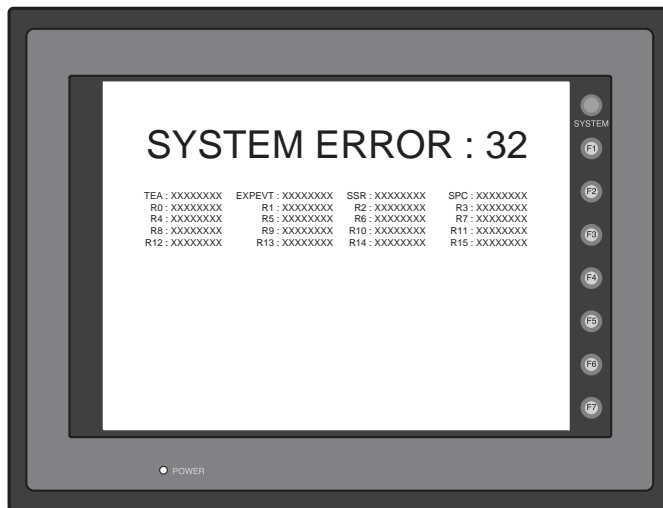

ERROR: XX

- 1: Watch dog timer error
- 11: Switch table error
- 30: Request for displaying full error
- 31: Memory allocation system error
- 32: General exceptions/MMU address system error
- 33: RTOS system error
- 34: Memory error
- 35: Inaccurate memory error

The source of the error could be one of the following three problems. Contact your local distributor.

- 1) Program crash due to noise
- 2) Hardware problem
- 3) Bad program

Solve relevant problems by following the directions in "Troubleshooting" (page 7-7).

If the problem persists, contact your local distributor.

5. Touch Switch is Active

If the power is turned off while a touch switch is activated, the error screen shown on the right is displayed.

Remove your finger from the screen.

If the error screen remains displayed, contact your local distributor.

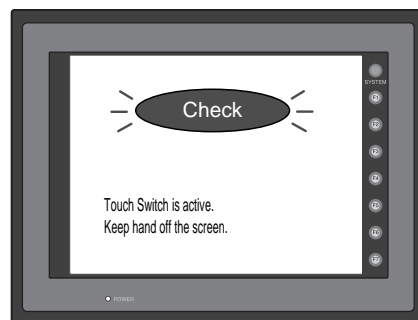



2. Troubleshooting

In the Event of an Error

Perform the steps below:

1. If the current error matches a symptom in the following table, correct it by following the instructions provided.
2. If the error does not match the symptoms in the table, contact your local distributor. Please provide the distributor with the information on the MONITOUCH model, serial number, symptom of the error, error message (if shown), etc.

Probable Symptoms

Symptom	Cause	Solution
<p>MONITOUCH is connected to the PLC; however, communication fails. "Communication Error: Time-Out" appears on the screen.</p> 	<p>Probable causes are:</p> <ol style="list-style-type: none"> 1) Cables are not connected correctly or any cable is disconnected. 2) PLC parameter settings are not correct or disagree with the MONITOUCH settings. 3) The MONITOUCH is faulty. 	<p>Solutions are:</p> <ol style="list-style-type: none"> 1) Check the cable connection. 2) Recheck the PLC parameter settings. 3) Perform a self-loop test on the "I/O Test" screen (page 6-5). If the test is not successful, please return the MONITOUCH to your local distributor immediately.
<p>Communications have been successful. However, opening a certain page always causes a "Communication Error: Error code received" error.</p> 	<p>The error code denotes a PLC error (NAK).</p> <ol style="list-style-type: none"> 1) When the error code appears only on a certain screen, a memory address that does not exist on the PLC may be set on the MONITOUCH screen. 2) When the error code appears at power-on, a memory address that does not exist on the PLC may be set for communication parameters, buffering area, initial macro, etc. 	<ol style="list-style-type: none"> 1) Check if any address outside the allowable range for PLC memory is set on the screen. 2) Check if any address outside the allowable range for PLC memory is set for communication parameters, buffering area, initial macro, etc.
<p>Communications have been successful. However, "Communication Error: Parity" or "Communication Error: Framing" suddenly occurs.</p> 	<p>Noise may cause the error.</p>	<p>Check if appropriate measures are taken against noise.</p> <p>Example: Check if communication and power cables are bundled together. Try to attach a ferrite core to the communication cable. Try to attach a noise filter to the power supply, etc.</p>

Symptom	Cause	Solution
<p>"SYSTEM ERROR: xx" occurs.</p> 	<p>The following causes are probable, depending on the symptoms.</p> <ol style="list-style-type: none"> 1) Turning the power off and back on corrects the error. ↓ Communication failed because of improper timing. 2) Turning the power off and back on does not correct the error. ↓ A certain condition always causes the error. Or the MONITOUCH is faulty. 3) A CF card is inserted. ↓ The CF card (front and back) may be reversed. <p>If none of the above matches your error, contact your local distributor.</p>	<ol style="list-style-type: none"> 1) If communication is stable after turning the power on again, continue and observe operation. 2) Make a note of the information on error number, etc. displayed on the screen and contact your local distributor. 3) Check that the inserted CF card faces the correct side.
Switches do not work.	<ol style="list-style-type: none"> 1) Switches do not work in the RUN mode. A beep sounds. ↓ Is the switch interlock enabled? 2) Switch activation position is wrong. On the "I/O Test" screen displayed from the Main Menu screen, press the [Switch Check] switch. On the touch switch test screen, a position different from the pressed position is activated. ↓ The switch activation position may be misaligned. 3) Switches do not work even in the STOP mode. On the "I/O Test" screen displayed from the Main Menu screen, press the [Switch Check] switch. When the touch switch test screen is pressed, nowhere is activated. ↓ MONITOUCH switches may be faulty. 	<ol style="list-style-type: none"> 1) Check the settings of switch functions, etc. on the V-SFT editor. 2) Perform a touch switch adjustment (page 6-10). 3) Return the MONITOUCH to your local distributor.
The screen becomes dark or black.	<ol style="list-style-type: none"> 1) Touching the screen restores it to the previous illuminated state. ↓ The backlight operates automatically as preset. 2) Touching the screen does not restore it. However, the POWER lamp is lit. ↓ The backlight may be at the end of its life. Or the MONITOUCH may be faulty. 	<ol style="list-style-type: none"> 1) The time for turning off the backlight can be changed on the V-SFT editor. 2) Return the MONITOUCH to your local distributor.
Screen data cannot be transferred.	<ol style="list-style-type: none"> 1) Screen data transfer has never succeeded. ↓ There may be some errors in the settings on the computer. 2) Screen data transfer was possible, but is disabled now. ↓ The MONITOUCH may be faulty. Or, there may be some errors in settings. 3) Transfer via Ethernet There may be some errors in the Ethernet setting. 	<ol style="list-style-type: none"> 1) In the [Transfer] dialog box on the V-SFT editor, decrease the baud rate by one level. Also check that the correct COM port is selected. 2) Check if the modem connection mode is selected. ("Modem Connect Mode" displayed at the bottom of the Main Menu screen denotes the mode) Also perform an RS-232C self-loop test (page 6-5). 3) Check that the IP addresses set on the V-SFT editor and the MONITOUCH are the same. Also check if any error due to Ethernet connection occurs on the MONITOUCH. <p>If the problem persists, contact your local distributor.</p>

8

Inspection and Maintenance

1. Inspection and Maintenance
2. Warranty Policy

1. Inspection and Maintenance



DANGER

Be sure to turn off the power before conducting inspection or maintenance. Failure to do so could cause an electric shock or damage to the unit.

Daily Inspection

- Check that the screws on the MONITOUCH are tightened firmly.
- Check that the connectors and terminal screws used for connection with other devices are tightened firmly.
- If the display surface or frame is dirty, wipe it with a soft cloth soaked in alcohol (commercially available).
- Conduct periodical inspection once or twice a year. The number of inspections may be increased as necessary if facilities are relocated or modified, or the environment is hot, humid, or dusty.

Periodical Inspection

Inspect the following points periodically.

- Are the ambient temperature and humidity appropriate?
0 to +50°C, 85%RH or less
- Are the environmental conditions appropriate?
- Does the atmosphere contain no corrosive gas?
- Is the source voltage in the allowable range?
With AC power supply: 100 - 240 VAC
With DC power supply: 24 VDC \pm 10%
- Are the MONITOUCH mounting screws tightened firmly?
- Are the connectors and terminal screws used for connection with other devices tightened firmly?
- Is the lithium primary battery within the expiry date?

2. Warranty Policy

Inquiries about Failure

Please direct inquiries about failure or repair to your local distributor. Your information on the MONITOUCH model, serial number, symptom of the failure, error message (if shown), etc. will be appreciated.

- * An inquiry form is provided on the final page (page 8-3) of this chapter. The form may be used for your inquiry.

Warranty Period

The product is under warranty for one year after the date of purchase or delivery to the specified place. On the assumption that the maximum stock period of the product after manufacture is 6 months, the warranty period is limited to 18 months (checked by the serial number) after manufacture. When a warranty period is specified in the contract, however, the period in the contract takes precedence.

Free-of-charge Repair

If the product fails before the expiry of the warranty, it will be repaired free of charge. However, repair of any failure resulting from the causes below will be chargeable even within the warranty period.

- Breakage of or damage to the appearance (case or surface sheet), touch switches, LCD, or other components due to dropping, impact, or mishandling
- LCD or backlight at the end of life
- Fusion of a printed circuit board pattern associated with connection to external devices, or fusion of a pattern in the terminal block or connector section of a printed circuit board caused by short-circuiting of external load circuit
- Overvoltage or different voltage applied due to wiring mistake (power supply terminal, external communication terminal, or other terminal blocks)
- Failure caused by lightning surge
- Failure due to the entry of conductive substances, water, solvent, particles, etc. under inappropriate environmental conditions
- Failure due to inappropriate environmental conditions (e.g. corrosive gas or high humidity)
- Failure due to vibration or impact exceeding the specified level
- Disassembly and modification by the customer or failure obviously resulting from improper handling by the customer

Chargeable Repair

Any failure that occurs after the expiry of the warranty or does not satisfy the requirements for the free-of-charge repair will be repaired on a chargeable basis.

Inquiry Form

Your name			
Company name			
Contact	E-mail:		
	TEL:		FAX:
Model code (*1)			Ser. No. (*1)
MONITOUCH version (*2)	SYS. PROG. Ver. :		I/F DRV. Ver. :
Purchased from: (Name of distributor)			
Date of purchase			
Symptom (Please describe the symptom of the failure and also include the error message if any is displayed.)			

*1 See the label on the back of the MONITOUCH for the model code and serial number (seven digits plus one letter of the alphabet).

*2 Enter the version if it can be checked. The version is displayed on the Main Menu screen (page 6-3).

Serial number



MEMO

Please use this page freely.



MONITOUCH



Hakko Electronics Co., Ltd.

Sales	890-1, Kamikashiwano-machi, Hakusan-shi, Ishikawa, 924-0035 Japan	
	TEL +81-76-274-2144	FAX +81-76-274-5208
Tokyo Office	TEL +81-3-5767-6160	FAX +81-3-5767-6170
Nagoya Office	TEL +81-52-219-2006	FAX +81-52-219-2088
Osaka Office	TEL +81-6-6341-8515	FAX +81-6-6341-8519
Hiroshima Office	TEL +81-82-568-0905	FAX +81-82-568-0922